

New Advances in Printed Circuits



United States Department of Commerce

National Bureau of Standards

Miscellaneous Publication 192

Printed Circuit Techniques

- . . . Printed circuits have emerged from purely laboratory experiments to become one of the most practical new ideas of mass production of electronic devices. Although many of the techniques were known and used long ago, printed circuits as we understand them today represent a comparatively recent accomplishment. Printed Circuit Techniques presents a comprehensive treatment of the subject.
- . . . The scope of the book is indicated by the following chapters:

Painting	Die-Stamping
Spraying	Dusting
Chemical Deposition	Performance
Vacuum Processes	Applications
- . . . The book consists of ten chapters, totaling forty-three large, two-column pages. It is adequately illustrated with twenty-one halftones, eighteen line cuts, and five tables.
- . . . Available from the Superintendent of Documents, U. S. Government Printing Office, Washington 25, D. C. Price: 25 cents a copy.

New Advances in Printed Circuits



**Proceedings of the First Technical Symposium
on Printed Circuits held October 15, 1947, in
Washington, D. C., under the Sponsorship of the
Aeronautical Board and Technical Direction of the
National Bureau of Standards**

Miscellaneous Publication 192

Issued November 22, 1948

PREFACE

The wide interest shown in printed circuits by Government, scientific and industrial organizations throughout the country, since the first release of information by the National Bureau of Standards in February 1946, increased to the point where it was found desirable to call a general technical symposium for the purpose of bringing together all interested persons and affording a free and open presentation of the status, applications and limitations of the art.

The symposium was sponsored by the Electronic Components Subcommittee of the Aircraft Radio and Electronics Committee of the Aeronautical Board with the cooperation and under the technical direction of the National Bureau of Standards. The meeting was held in the Department of Interior Auditorium, Washington, D. C., on October 15, 1947. Twenty speakers and an audience of over 700 persons reviewed the many methods of printing circuits. New techniques were described in detail, many examples of new approaches to the method of printing circuits were demonstrated, and a number of samples were exhibited by manufacturers.

Since the symposium did not treat, and hence these proceedings do not include, all details of printed circuits, the reader is referred to National Bureau of Standards Circular 468, "*Printed Circuit Techniques*" for a complete treatment of printed circuit techniques.

E. U. CONDON, *Director.*

FOREWORD

The authors of this volume are men who were either responsible for or played an important role in the developments described. It was beyond the scope of the symposium to attempt to cover completely all the various processes, applications, and other matters related to printed circuits. Several of the principal methods have been treated in detail; others have only been introduced, with the thought of stimulating further interest and experimentation in the processes by laboratories throughout the country.

The symposium was opened by Mr. R. J. Framme, Chairman of the Electronic Components Subcommittee. The general interest of the Armed Services in printed circuits was indicated by the introductory remarks of General F. L. Ankenbrandt, ACO, Headquarters USAF and Captain Frank Akers, USN, Bureau of Aeronautics. General Ankenbrandt said that:

The Electronic Components Subcommittee of the Aeronautical Board has noted that new electronic developments concerning printed circuits are particularly adaptable to aeronautical needs. The reasons are quite easy to see: You have the inherent advantages of extremely small size, light weight, simple fabrication, extremely durable materials and low costs. This technical symposium of all interested persons of Government and industry has been arranged to provide opportunities for the exchange of ideas and to promote rapid dissemination of information on printed circuit techniques . . . Printed circuitry came into its own during the war, and being pushed very rapidly, quite a number of highly classified applications were developed and actually put into use. The Military has been extremely aware of the wide application of printed circuits to industry as a whole and consequently has been very glad to declassify the techniques developed during the war. These techniques are for the use of industry and the world as a whole for the advancement of the electronics art. Naturally, the Military have their own specialized applications. It takes very little imagination to see where printed circuitry will fit into aircraft electronics equipment. We want the lightest equipment possible. Someone once said, "We want electronics equipment that takes up no space, weighs nothing, but will do everything". Perhaps we almost have this in the form of printed circuits.

Captain Akers pointed out that:

We (the Navy) are becoming concerned over the increase in weight and bulk in our equipments, particularly in aircraft design. Today with the modern high performance airplane, electronics is a must if we are to get the benefit of the tremendous performance available. A new Navy jet fighter has so much of its space taken up by large air ducts necessary to feed its jet engines that we are unable to install tactical communication equipment without repackaging it . . . We have made electronics equipment smaller, have made it lighter and *have made it work*. We have miniature tubes, are bringing out sub-miniature tubes, potted circuits and printed circuits, the greatest weight and space saver of them all. We need to carry this further to handle the more complex problems and to better control the characteristics under varying environment. The purpose of this symposium is to bring you up to date on the progress and particularly to make all and the latest information available to equipment manufacturers.

Attention is called to the summary of data obtained from the questionnaires filled out by the persons attending the symposium. This information, which follows the formal papers, suggests the potential possibilities and applications of printed circuits.

CLEDO BRUNETTI, *Editor*.

**Electronic Components Subcommittee
of the
Aircraft Radio and Electronics Committee of the Aeronautical Board**

MR. R. J. FRAMME, Chairman, Air Matériel Command, Wright Field, Ohio.

MR. HARRY MULKEY, Air Matériel Command, Pentagon Bldg., Washington 25, D. C.

MR. ALVIN SALTZMAN, AMC, Watson Laboratories, Red Bank, N. J.

MR. A. W. ROGERS, Signal Corps Engineering Laboratories, Fort Monmouth, N. J.

MR. A. E. ZDOBYSZ, Bureau of Aeronautics, Navy Department, Washington 25, D. C.

MR. J. N. HALL, Bureau of Ships, Navy Department, Washington 25, D. C.

MR. F. M. GAGER, Naval Research Laboratory, Anacostia, Washington 25, District of Columbia.

DR. CLEDO BRUNETTI, National Bureau of Standards, Washington 25, D. C.

MR. LEW SIECK, Secretary, Aeronautical Board Secretariat.

The symposium was presided over by Dr. Cledo Brunetti. The proceedings were prepared under the editorship of Dr. Brunetti with the assistance of D. S. Hoynes and W. J. Cronin of the National Bureau of Standards. Assistance in planning the symposium was also rendered by Dr. R. W. Curtis of the Bureau's staff.

CONTENTS

	Page
Preface	II
Foreword	III
1. Status of printed electronic circuits.....	1
2. Centralab printed circuit techniques.....	10
3. Conductive silver preparations.....	15
4. Printed resistors	17
5. Metal films and their application to the fabrication of resistors and printed circuits.....	25
6. Trends in military communication and the applicability of printed circuits.....	27
7. Vitreous enamel dielectric products.....	30
8. Printed electronic components on glass.....	34
9. Electrical circuits on plastics and other nonconductors.....	36
10. Imprinted circuit inlays.....	41
11. Spraying techniques for producing electronic circuits.....	42
12. Physical aspects of printed circuit conductors.....	44
13. Mechanization of electrical wiring.....	46
14. Die-stamped wiring.....	48
15. Printed circuit production	51
16. Prefabricated components for printed circuit application.....	54
17. Typical commercial applications.....	61
Two stage printed circuit amplifiers.....	61
Printed circuits in transmitters and receivers.....	61
First application of the printed circuit to a hearing aid.....	62
Mycalex 410 base plates for printed circuits.....	64
Printed inductors.....	64
Herlec bulplates.....	65
18. General discussion.....	66
Summary	66
Questions and answers.....	68
Summary of questionnaires.....	72

1. Status of Printed Electronic Circuits¹

Printed circuits have emerged from purely laboratory experiments to become one of the most fascinating new ideas of mass production of electronic devices in many years. Although some of the techniques employed in the practice were known and used long ago the printing of complete electronic circuits is a comparatively recent accomplishment. Interest has increased steadily since February 1946, when the military approved the release of the development which had played an important part in the design of the miniature radio proximity fuze for the trench mortar shell. Printed electronic components and subassemblies have been manufactured in large quantities, and the first commercial electronic set designed for and produced by the printed process, a hearing aid, has been placed on the market.

Over the past 2 years the National Bureau of Standards has received an unprecedented demand for technical information on the subject from other Government agencies, from industry and scientific institutions. Because of this interest, a thorough study of the techniques was undertaken. This study, to which valuable contributions were made by many industrial and scientific organizations, revealed a large number of possible methods for condensing the size of electronic assemblies, for mechanization of electronic wiring and for reducing the wiring essentially to two dimensions.²

These methods are simply different ways of reproducing a circuit design upon a surface. Since printing may be defined as "The act of reproducing a design upon a surface by any process," the methods have come to be classified as printing techniques. The Bureau's studies unfolded so many methods of printing circuits that it would take much of the remainder of the symposium merely to introduce each properly. Listed below are twenty-six individual methods, each distinct from the other. Combinations of these methods have also either been used or proposed but will not be described at this time. The methods are distinguished principally by the way in which the conductors, resistors, inductors, capacitors, or combinations of them, are applied. Inductors for high frequency circuits are usually printed in the same operation as the conductors. Electronic tubes

are attached by hand or machine soldering, or by solder-dipping. Other components such as transformers, electrolytic capacitors and speakers are attached by conventional methods. Unless otherwise mentioned, both conductor and resistor paints are applied in the same manner.

The following is a partial list of all the known methods, described by their principal features:

1. Painting conductors and resistors with a brush, and soldering on tiny disk capacitors;
2. Stenciling conductors and resistors in place using suitable paints (this is often referred to as the stenciled-screen process);
3. Stenciling or painting the circuit onto a base plate which incorporates vitreous dielectric capacitors within itself;
4. Stenciling conductors and capacitors in the same operation, using silver paint and a base plate of high dielectric constant;
5. Stenciling the conductors on a phenolic base plate prior to curing, and curing phenolic and paint simultaneously;
6. Printing conductors using silver paint and ordinary newspaper printing press techniques;
7. Application of resistor and conductor paints with special ruling or fountain pens, brushes or pencils;
8. Application of paints with ordinary rubber, metal or plastic stamps;
9. Application of paints, using steel or copper plate engraving techniques;
10. Dipping the stencil-coated surface into a suitable paint;
11. Spraying resistor and conductor paints through masks or stencils;
12. Spraying molten metal conductors through a stencil;
13. Spraying molten metal onto a premolded panel, then machining or grinding to bring out the circuit pattern;
14. Die casting or pouring metal into preformed grooves in an insulating surface;
15. Spraying or pouring chemical silvering and reducing solutions onto a stencil-coated panel to deposit metal films in the form of the desired circuit. With proper choice of metallic salts, it is possible to produce printed circuits in colors;
16. Imprinting a catalyst onto an insulating panel and depositing copper in the desired circuit pattern;
17. Evaporating metal films on panels through a stencil in a vacuum;
18. Evaporating a metal film completely over the base plate and spraying off the metal with

¹By Cleo Brunetti, Chief, Engineering Electronics Section, National Bureau of Standards.

²Many of the technical details of printed circuits presented herein have been abstracted from a circular entitled "Printed Circuit Techniques" prepared by the National Bureau of Standards. Further information regarding any of the processes may be obtained by consulting the circular, available from the Superintendent of Documents, U. S. Government Printing Office, Washington 25, D. C.; price 25 cents.

an abrasive through a circuit-defining stencil;

19. Cathode-sputtering metal films on panels through a stencil in a vacuum;

20. Cracking hydrocarbons at high temperature onto a stencil-coated surface to produce resistors;

21. Die-stamping circuit wiring from a metal plate and soldering or riveting to a panel;

22. Die-stamping circuit wiring out of foil or thin metal sheet and either pressing into an adhesive coated surface in one operation or attaching later with adhesive;

23. Die-stamping metal foil onto a panel using a hot-die which imprints a metal pattern of the circuit into the surface;

24. Dusting carbon or metallic powders onto a tacky surface through a stencil and either firing or electroplating;

25. Applying conducting powders to a surface in the proper circuit pattern by electrostatic means, then flash firing the powder;

26. Making up decalcomanias with the metallic circuit pattern, then applying to the surface and removing the decalcomania by firing.

These methods may be divided into six principal classes: painting, spraying, chemical deposition, vacuum processes, die-stamping, and dusting.

Painting

Metallic paints for conductors, inductors and shields are made by mixing metallic powder with a liquid binder to hold the particles together and a solvent to control the viscosity. Resistance paints are made in similar fashion using either carbon or metallic powders. The circuit is painted on the surface by brush, stencil, printing process or any of the other methods outlined above. Tiny disk capacitors and subminiature tubes are added to complete the electronic unit. If desired, the capacitors may be incorporated directly within the base plate itself by a vitreous dielectric process.

Since the techniques of applying paints to most types of surfaces are to be treated in many of the other papers on the program, only the status of the art will be treated here. It is possible to purchase paints for conductors ready-mixed and applicable to almost any solid surface. Resistor paints are not readily procured although the ingredients are available commercially. Like most commercial formulas which have been developed at considerable cost to the organization selling the product, most of the resistor paint formulas are justifiably regarded as trade secrets. Some insight as to the

³ See tables 1 to 3, pp. 6 to 8, "Printed Circuit Techniques," Superintendent of Documents, U. S. Government Printing Office, Washington 25, D. C.

composition of paints has been attained as the result of limited experiments at the National Bureau of Standards.³

Paints for printed circuits are made up of selected combinations of constituents, the most important of which are the pigment or conducting material, the binder which holds the pigment on to the surface, and the solvent, which adjusts the viscosity. In those cases where it is not possible to heat the base plate to high temperature (as, for example, when a thermoplastic base plate is used), a reducing agent is substituted for the solvent. Such a paint for conductors could, for example, be made of silver oxide, linseed oil and a reducing agent such as hydrazine sulfate. The filler is used only in resistors, when needed to increase the resistance value. Protective coatings are applied to both resistors and conductors for protection against atmospheric conditions and mechanical abuse.

It was found at the National Bureau of Standards that the preparation of conductor paints is not an unusually difficult task although careful attention to the quantity and quality of the ingredients is necessary if good adhesion to the base plate and high conductivity is desired. The table shows formulas for use on base plate materials ranging from ceramics to the thermoplastics.

In the present state of the art, it is not feasible to present a set of resistor paint formulations which one may use without special attention in the laboratory. A paint formula which is successful for one experimenter may not work well for another because of the manner in which the ingredients are mixed, the quality of the ingredients, the amount of evaporation of solvent prior to application, or any one of other small but important factors.

So far as is known, there is no single paint formula which can be used to print resistors from one ohm to several hundred megohms. To cover the complete range, it is necessary to use several paint mixes and vary the number of applications as well as the dimensions of the printed resistor.

Current knowledge points to the use of carbon-blacks of relatively small particle size for resistor paints, those of particle diameter in the range of 20 to 50 millimicrons. The carbon should have its surface impurities, principally oxygen, removed by calcining, that is by heating to a temperature of approximately 1,050° C for 4 hr., preferably in an inert atmosphere such as nitrogen. After calcining, the carbon is dispersed in the binder by ball milling. The composition, size and density of the balls, the speed of the mill and milling time are all important factors in this operation.

Much also remains to be learned about the

factors contributing to noise in resistors. Noise appears to be a function of particle size; the finer the carbon, usually the less the noise. This is perhaps due partly to the fact that smaller particles present more contacts. A good deal of experimentation, including X-ray and electron microscope studies, is now underway seeking to clarify the effect on resistor performance of carbon particle size and shape, particle arrangement in solution, and other factors.

A conventional printing press may be used for printing conductors on a base plate. This press, of course, may be operated by hand or power. In such a press, the soft rollers first pass over the ink plate which is coated with conducting ink. On the return motion, they sweep over the block which carries the metal pattern of the circuit to be printed and coat it with a layer of ink. In the final step, the carrier bearing the insulated base plate on which the circuit is to be printed presses this plate firmly against the inked block thus impressing the desired pattern on the base plate. Units of this type may print a layer of silver paint 0.002 or 0.003 in. thick. To increase the conductance, the printing operation may be repeated.

Spraying

The spraying of conducting films on insulating surfaces, like the spraying of ordinary lacquers and paints, not only has popular appeal but is fairly easy to adapt to production line practice. A successful development of one spraying technique will be presented later in the program, hence the subject will be treated only in general terms here. Either molten metal or paint may be sprayed onto an insulating surface through a stencil using a suitable spray gun. In some processes, metals in the form of wire, powder or solutions are supplied to the gun and sprayed directly on the surface through stencils to form the conductors. The same operation also fastens in place resistors, capacitors and other electronic components which have previously been set either within or under the panel with their leads making junctions with the conductors. Conductor and resistor paints may also be sprayed. In spraying resistors, the electrical values may be controlled by controlling the speed of the conveyor belt which carries the work under the spray gun as well as by regulating the flow of material from the gun.

Chemical spraying is possible, using a spray gun with two openings, one ejecting a silvering solution and the other a reducing liquid. Another method which accomplishes the same re-

sults as spraying is a process wherein the system of conductors is die cast into the desired pattern on an insulating base. Recesses for the conductors are molded into the base plate and an alloy chosen for the conductors which expands on cooling thus holding them firmly within the base. Helical resistors for electric heaters are made by setting up a metal spray gun on the carriage of a lathe and spraying a helix on a ceramic tube, using the thread-cutting mechanism of the lathe. The spray gun beam is defined by a suitable aperture.

A novel method adaptable to electronic wiring involves "spraying-off" the metal from a metal-plated plastic to leave the desired circuit wiring. A plastic or other insulator having on its surface a thin evaporated coating of metal such as silver or copper has a stencil applied over the surface by a photographic process. When the surface is exposed to a spray of abrasive material, the metal is removed from all parts not covered by the stencil. With this method, circuit wiring including resistors and inductors may be printed with a dimensional tolerance of ± 0.0002 in. The process may be used to trace out contacting segments and other related components of electrical systems such as radio sonde elements.

Chemical Deposition

This process involves the well known methods of silvering mirrors. A stencil is placed over the base plate and a silvering solution poured on it. Standard silvering solutions such as silver nitrate mixed in ammonium hydroxide may be prepared which, with the addition of a reducing agent, serve to precipitate metallic silver onto the insulating surface. Thin metallic films of relatively low conductance are formed. The films cannot be soldered to directly. They may be built up by repeating the silvering process as often as desired or, more practically, by electroplating.

Not only silver films but those of copper, nickel, gold, iron and other metals and alloys, such as silver-copper, may be deposited on insulating surfaces by chemical methods. An interesting variation is offered by the possibility of selecting the metallic salts so that metal films of different colors are deposited, thus allowing the printing of colored electronic circuits. Circuits of different colors may be used for identifying different sections in a multisection unit, for classifying as to frequency and volume ranges and other uses. Usually, however, such metallic salts produce high resistance films and as such may be used to produce resistors of limited wattage.

Vacuum Process

The vacuum techniques employed to produce metallic layers of nonmetallic surfaces which may be adapted to electronic wiring are those of cathode sputtering and evaporation. In the sputtering process, the metal to be volatilized is made the cathode and the material to be coated, the anode. After evacuation, a high voltage is applied between them. Metal emitted from the cathode is attracted to the plate by maintaining the plate at positive potential. In the evaporation process, the metal is heated in a vacuum to a temperature at which it evaporates onto the work located nearby. After the base plate is coated, the stencil is peeled or burned off leaving the desired circuit wiring.

The more practical of the two methods at present appears to be the evaporation process. A simple procedure is to place the metal in a vessel and heat it to vaporizing temperature by means of either a flame or induction heating. The plates to be coated may be placed upside down on a supporting grid over the vessel. The thin films formed, as in the case of the chemical deposition methods, may serve either as resistors or, when plated, as conductors. Accurately defined areas may be coated by the evaporation process thus improving the uniformity of the resistors.

Die-Stamping

There are several methods of producing electronic circuits by the die-stamping process. In one, a wiring grid is punched out of 1/16-in. copper plate and silver plated. The grid is then placed over an array of projecting lugs attached to various electrical components. It is soldered to all of the lugs in a single automatic operation. The parts of the grid not desired are clipped out and the remainder forms the complete wiring of a telephone set. In another method, circuit wiring is punched out of metal foil and attached to one or both sides of an insulating panel.

Radio set manufacturers are now employing spiral loop antennas die-stamped from copper or aluminum sheet a few thousandths of an inch thick. One design is formed by feeding an automatic punch press with a composition or plastic panel having a metal sheet over it. The sheet is coated on one side with a thermoplastic cement. The press has a vertical reciprocating steel die with the antenna pattern on its face. In a single stroke the die cuts the metal sheet and attaches it to the panel. The result is a combined antenna and back or housing for a receiver. The process has been extended to stamping out conductors as well.

The hot stamping process used in the marking of leather and plastic materials lends itself to the mechanization of electronic circuit manufacture. In this method, a hot die engraved with the pattern of the conductors, including inductors, is pressed onto the plastic with a thin sheet of gold, silver or other conducting foil between the hot die and the plastic. The foil adheres to the plastic where the pressure and heat from the die have been applied, and can be brushed away at other places, leaving a pattern of conductors. Samples produced with gold foil have proven satisfactory. The resistors may be applied in the same way using resistor material deposited on a film of plastic previous to the hot stamping operation. Since foils as thick as 0.002 in. may be used, very good electrical properties are obtained, particularly with inductors made by this method. Other components to complete the electronic circuit may be added by riveting, soldering or spot welding.

Dusting

In the dusting techniques, metallic powders with or without a binder are dusted onto a surface in a wiring pattern and fired. The powder may be held to the surface by coating the latter with an adhesive through a circuit-defining stencil. Metal adheres to the surface in the desired circuit pattern and fuses strongly to it on firing.

In one process a suitable bonding material is selected, such as shellac, wax or any of the synthetic resins. The material is dissolved in alcohol or benzine and a thin layer of the solution is sprayed or painted onto the surface. A stencil bearing the circuit pattern is placed over it and leafed silver powder dusted on. The unit is then subjected to a temperature which drives off the bonding material and fuses the metal to the plate. A variation is to apply the bonding material instead of the paint through the stencil. The powder is sprinkled on after the stencil is removed and while the bonding surface remains somewhat tacky.

An electrophotographic method has been developed to hold the powder to the surface in the proper pattern prior to flashing. It is applicable to any of the usual nonconducting surfaces, including paper. The surface is first coated with photoconductive material, then placed under an electrostatic charging device. The electrostatic field produces a charge on the surface coating. Exposure to light through a positive photograph of the electronic circuit removes the charge from that portion of the photoconductive material illuminated and leaves an electrostatic image of the circuit. A mixture

of leafed silver powder and a binder dusted onto the surface adheres only to the charged image. Flashing with a flame produces a pattern of thin silver films, completing the wiring.

Applications

Printed circuits have now been applied to the design of audio, radio and VHF amplifiers, detectors, oscillators, trigger circuits, hearing aids, electrical instruments, radio sets, meteorological instruments, electronic ordnance equipment, remote control equipment, radar, subminiature radio transmitters, receivers and transceivers and even toys and games. Several of these applications will be described in the papers to follow.

Amplifiers, special electronic sets and small radio transmitters and receivers made in the Bureau's laboratories, have shown performance qualities comparable to equipment built along conventional lines, as well as improved miniaturization and ruggedness. Complete circuits have been printed not only on flat surfaces but on cylinders surrounding a radio tube and on the tube envelope itself.

Observance of good electronic wiring practice is as essential to the successful design of printed circuits as it is in standard circuits. In printed circuits the parts are usually placed very close to each other; hence the lay-out must be such that the components do not affect each other adversely while the circuit is in operation. In most applications the circuit arrangement may be chosen in any convenient manner. It will be found convenient and economical to lay out the painted circuit in such a way as to keep the length of leads to a minimum and to avoid cross-overs. Cross-overs are handled by going through the base plate and continuing on the opposite side, by going over the edge, or by cementing or spraying a thin layer of insulating material over the lead crossed.

If the design permits, some advantage may be gained by placing the low values of resistance on one side of the plate and the higher values on the other. This reduces the number of paint applications per face required to produce the requisite number and range of resistors. High values of resistance may be painted in a small space by zigzagging the lines in any of the several variations used to denote resistors in conventional wiring diagrams. If resistors of large power capacity are needed, they may be painted on the inside of the cabinet housing the set. The resistance may also be divided in two or more parts each placed on a separate wall to dissipate the heat better and further increase the power rating.

A significant advantage of printed circuits is that once manufactured they are less likely to be tampered with, for tampering is readily detected. A manufacturer who places a guaranteed instrument or set on the market can readily determine if the circuit has been altered. Transmitters designed for a fixed frequency and set at the factory are less liable to be altered by the user. This is an advantage which may be of some value in the regulation of the use of personal radio telephones in the Citizens Communication Band.

A large variety of subminiature tubes are available which are applicable to the design of practically every type of low power electronic circuit (fig. 1.1B). These include many types of triodes for amplifiers, oscillators (including UHF types), electrometers, gas filled thyatrons, phototubes, diodes, tetrodes, twin tetrodes, diode-pentodes, converters and several different kinds of pentodes. The subminiature tubes have very low filament drain (10 to 200 m.a. at 1.5 to 6.0 volts). They work well as voltage or (limited) power amplifiers. Their power output varies from a few milliwatts to almost one watt. Triodes of general purpose and UHF types are available with amplification factors of 20 to 60 and mutual conductances up to 5,500 micromhos. At 500 megacycles some of them deliver as much as 700 milliwatts of output. RF pentodes have mutual conductances up to 5,000 micromhos and plate resistances from 0.1 to 3.0 megohms.

A complete two stage amplifier painted on the envelope of a miniature 6J6 tube requires only connection to a power supply to operate. The circuit wiring is applied with a stencil wrapped around the tube. For circuits on tube envelopes, paints are used that do not require baking at extremely high temperatures to drive out binder and solvents. In this way tube performance is not deteriorated by gases which may be released from its metal parts by the heat. The circuit may be applied to the tube envelope either before or after the tube elements are mounted in place. A glass tube was employed in the unit, although a metal tube might have been used after first coating the metal envelope with a layer of lacquer or other insulating material. Leads from the circuit to the tube prongs have been painted on with a brush. Wires may also be soldered to points directly on the tube envelope, ribbon type leads usually being employed.

It is generally desirable to avoid lead cross-overs. When this is impossible, cross-overs on glass may be made by painting a thin layer of insulating lacquer over the lead and, after drying, painting the cross-over lead over the lacquer. Another method is to place or cement

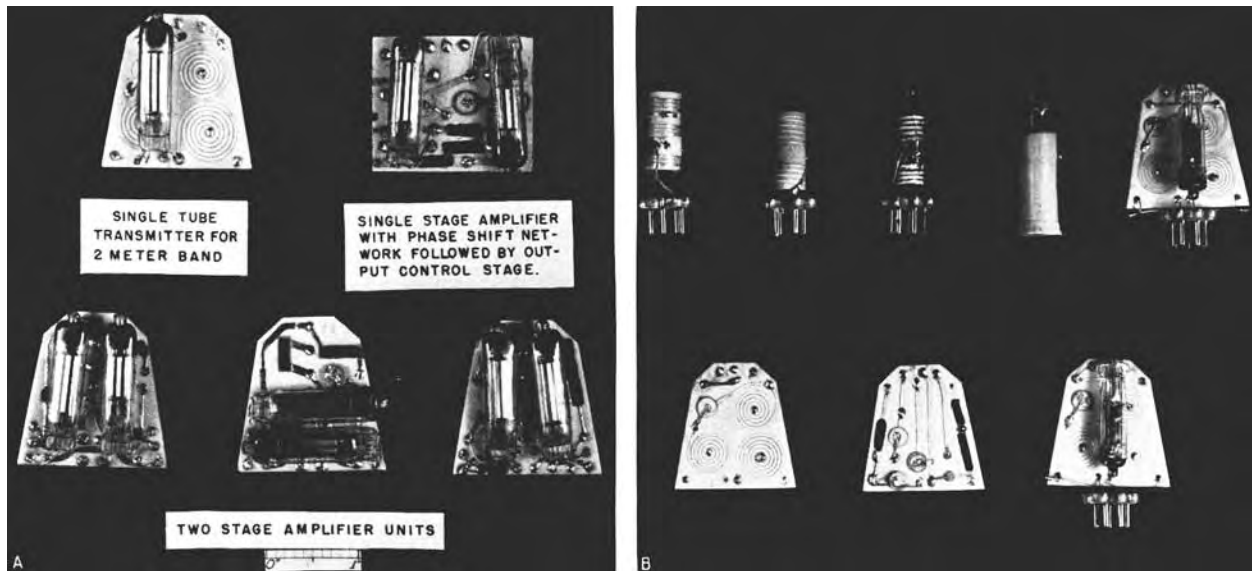

FIGURE 1.1

A, Examples of electronic circuits printed on steatite plates by the stenciled-screen process. To minimize size, subminiature tubes are employed.

B, top row, five types of subminiature 132-144 mc radio transmitters, utilizing printed circuit techniques. All types are grid modulated and require only connection to a microphone and battery to operate. The oscillator circuits of the two units at the left are printed on the outer surface of a thin steatite cylinder housing the subminiature tube. The circuit of the unit at center is painted on the glass envelope of a 6K4 subminiature triode $\frac{3}{8}$ in. in diameter and $1\frac{1}{4}$ in. long. The transmission second from the right is painted on the glass envelope of a T-2 tube measuring $\frac{1}{4}$ in. in diameter and 1 in. in length. The circuit of the transmitter at the extreme right is painted on a $\frac{3}{32}$ in. steatite plate, $1\frac{1}{2}$ in. wide and the same in length.

Bottom row, developmental stages of a steatite plate transmitter. The plate at the left carries three silvered spiral inductors and a single high dielectric constant ceramic capacitor. The reverse side of the plate (center) shows the silver wiring, three (black rectangular) resistors, and four circular ceramic capacitors. Next is the complete transmitter with subminiature tube and battery plug-in added.

a thin insulated strip such as Scotch tape over the lead and run a foil strip or ribbon over it. The cross-over ribbon is connected to the circuit by a drop of silver paint or solder at its ends.

A three stage amplifier printed by one manufacturer as a unit suitable for a hearing aid has a gain of 10,000. Included are a miniature volume control and specially designed clips to hold the subminiature tubes. It was printed on a ceramic plate by the stenciled-screen process.

Manufacturers have also placed on the market a variety of printed coupling circuits in which the dielectric material for the capacitors is the base plate itself. The base plate is made of material having a high dielectric constant. Conductors and capacitors are printed in the same stenciling operation. The result is an unusually compact unit. Even when entirely coated with a protective plastic cover, some of the units are only 0.06 in. thick. A diode filter circuit consisting of a resistor and two capacitors is 0.19 in. wide and 0.5 in. long. Other units such as audio coupling circuits and a-c/d-c radio subassemblies consisting of three resistors and three capacitors are 0.5 in. wide and 1.0 in. long.

A number of radio transmitters and receivers (figs. 1.1A, 1.2A), produced by the printed

circuit technique have been designed to operate in the Government short-wave band of 132 to 144 megacycles. These examples illustrate only a few of the wide number of possible applications of printed circuits. Silver and carbon paints were used to make the sets.

The five types of transmitters (fig. 1.1B, top row) are single-tube grid-modulated units, which require only connection to modulator and battery to operate. In the two units at the left, the oscillator circuit is printed on the outer surface of a thin steatite cylinder. The tube is inserted within the cylinder and the combination wired to a battery plug. The unit at the top center is a transmitter with the circuit painted on the envelope of the subminiature tube, a 6K4. It was made by first wrapping a stencil of the inductor pattern around the tube using masking tape. The glass envelope was then etched in fumes of hydrofluoric acid.⁴ The conducting paint was applied to the etched surface and allowed to dry in air. To improve the Q of the inductor, it was silver plated in a silver-cyanide bath.⁵ The grid-leak resistor was

⁴ Caution should be exercised when etching with hydrofluoric acid not to seriously weaken the glass envelope; also, in general, when oven-firing tubes for baking on printed circuits, temperatures should be kept well below the softening point of the glass.

⁵ Where strong adhesion is desired, it has been found advantageous to copper plate over the initial painted inductors prior to silver plating. A simple copper-sulfate bath may be used.

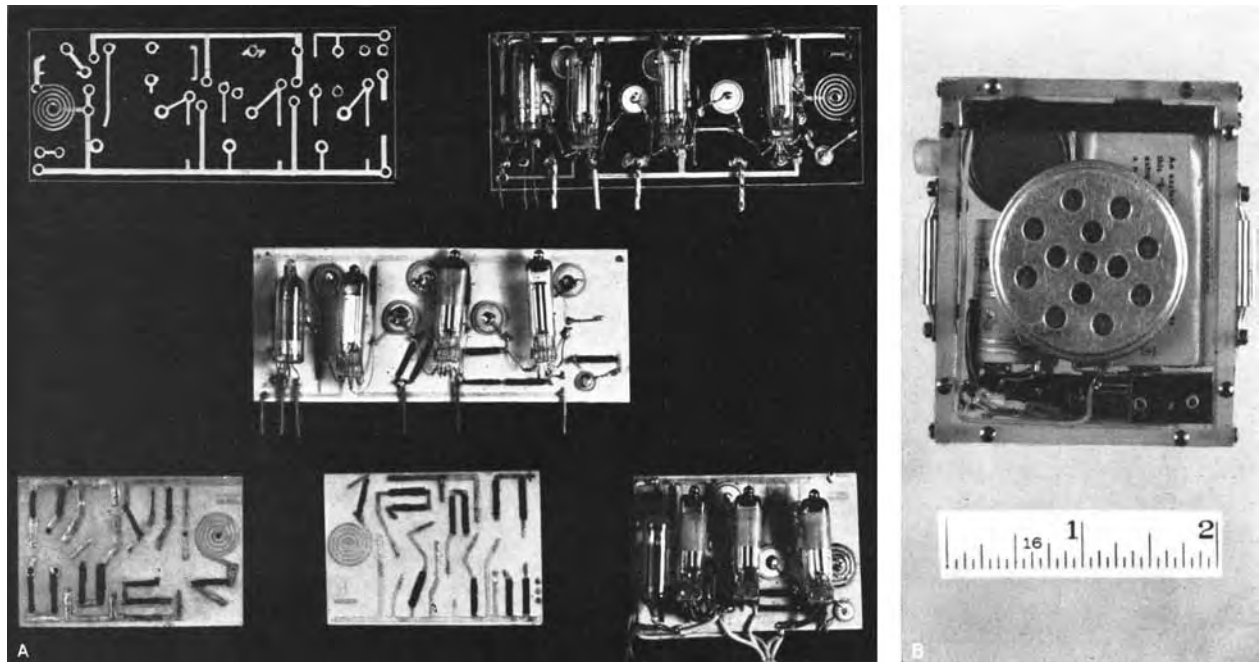

FIGURE 1.2

A, Top row, four-tube radio receiver printed on a $3/32$ in. lucite plate, 2 in. wide and 5 in. long. The silver circuit wiring (applied through a stencil) is shown on the plate at the left, with the completed receiver at the right. Battery and speaker are omitted. Center row, four-tube radio receiver unit printed on thin steatite plate. All receivers have four stages, consisting of an input stage of square law detection followed by two stages of pentode amplification, and a triode output stage feeding a permanent-magnet type speaker. Bottom row, two developmental stages of a four-tube radio receiver printed on a thin steatite plate, 2 in. wide and 3 in. long. The plate at the left shows a complete circuit wiring (less tubes and capacitors) applied free hand with a camels-hair brush except for the spiral inductors. Wiring on the center plate was applied with a squeegee through silk screen stencils. The leads from the complete receiver at the right are for a battery and speaker.

B, Two-tube wrist transmitter for personal use, complete with batteries.

applied with carbon paint and dried under an infrared lamp. The addition of a tiny high-dielectric ceramic capacitor completed the circuit on the tube envelope.

The circuit for the unit second from the right (fig. 1.1B, top row) is painted on the glass envelope of a tube measuring approximately $1/4$ in. in diameter and 1 in. in length. The silver inductors were applied with a ruling pen mounted on a lathe with the tube held in the chuck and rotated by hand. Both tube and circuit have been coated with a thin layer of plastic resin to protect against rough handling and humidity.

The circuit of the transmitter at the right (fig. 1.1B) was stenciled on a $3/32$ -in. steatite plate $1\frac{1}{2}$ -in. wide and the same in length. The development of the flat-plate transmitter (fig. 1.1B, bottom) shows three spiral inductors and a 50 micromicrofarad coupling capacitor on one side and the remainder of the circuit wiring including three resistors (the dark rectangles) and four capacitors on the reverse side. One of the resistors serves as a blocking resistor for testing the unit. Wiring of the units was completed by soldering the subminiature tubes and leads for the antenna, batteries, and microphone directly to the silver wiring on the plate.

A complete radio transmitter for personal use has been assembled in a small lucite case. This small transmitter (fig. 1.2B), employs a grid-modulated oscillator printed on a steatite cylinder housing a subminiature triode. A crystal microphone with a single stage of pentode amplification is used to grid-modulate the oscillator. Hearing aid batteries are used to power the set. The complete unit is included within a plastic housing $2\frac{1}{8}$ by $2\frac{5}{8}$ by $7/8$ in.

Two of the receiver units (fig. 1.2A), are on steatite plates 2 by 3 in. and 2 by 5 in. (bottom right and center, respectively) while the third is on a 2 by 5 in. lucite plate. They employ a square-law detector stage followed by two stages of pentode amplification and a triode output stage feeding the loud speaker. The input tuning is broad so as to allow reception over the complete band of 132 to 144 megacycles. All but the unit in the lower left corner were made by the stenciled-screen process. The circuit of the other, with the exception of the spiral inductor, was painted on with a camel's hair brush. The spiral inductors have all been silver plated. As silver plating is relatively easy, it was found convenient to plate all wiring on the base in the same operation.

Miniature microphones, speakers, and bat-

teries complete the transmitting and receiving units. The units also operate satisfactorily with standard large size microphones or speakers. The transmitter is plugged into a power pack, while the standard size carbon microphone with matching transformer is plugged into the other end. This arrangement has been used together with the 2- by 3-in. receiver mounted on the 10-in. console speaker with sufficient power to operate the speaker so that it could be heard throughout a fair sized auditorium. Personal transceivers incorporating printed circuits are being engineered for commercial use. One manufacturer has designed them for the proposed Citizens Communication Band, 460-470 megacycles.

The ease of replacing defective printed sub-assemblies in an installation introduces new possibilities in manufacture and maintenance, particularly applicable to complex equipment and to rural and foreign markets where maintenance is a difficult problem. This advantage is realized by the use of printed plug-in sub-assemblies. Principal units of a set can be removed, tested and replaced in the same manner as tubes are handled. It should be useful in areas where skilled repair men are not available and in applications where it is necessary to do trouble shooting under different conditions. With all major subassemblies wired in plug-in fashion, the repair man can replace all the subassemblies in the set, taking the old units back to the shop for checking. Such subassemblies have been encased in a special casting resin developed at the Bureau, useful at frequencies up to and beyond the VHF range. It is thus protected against manual abuse and atmospheric conditions.

Performance

Conductors

Sufficient data on the performance of printed circuits have been accumulated to show that they behave in a manner similar to conventional circuits. The current-carrying capacity of the usual printed conductor is more than sufficient for all currents used in low-power electronic circuits. For example, a silver conductor $\frac{1}{8}$ in. wide and about 0.0005 in. thick fired on steatite did not fuse until the current reached 18 amperes, while another $\frac{1}{16}$ in. wide carried 8 amperes for 9 minutes before fusing. Other data and curves of loading characteristics of printed conductors may be had from the publication, Printed Circuit Techniques, referred to above.

On plastic bases, where firing of the paint is not possible, the printed leads have a higher

resistance and less current carrying capacity. A lead 0.08 in. wide and 0.005 in. thick withstood only 0.5 ampere before the plastic base softened and the silver peeled off. Since heating tends to loosen the bond between the deposited metal and the plastic base, an experimental determination of the current carrying capacity should be made for each particular case. Lower and more consistent values of resistance and increased current carrying capacity are to be had simply by increasing the number of coats of paint or by electroplating.

Resistors

Among the principal factors affecting the power dissipated by a resistor are the paint mixture, the base material on which it is printed and the surface area. The composition of the paint determines the maximum temperature to which the resistor may safely be raised; the dimensions and properties of the base material and the area of the resistor are the principal factors which determine the rate at which heat is conducted away. The close contact of the printed resistor with the base material in the case of glass or ceramic, prevents local heating and gives the resistor better power dissipation than might at first be expected. Resistors painted on plastics tend to loosen from the base material on heating, hence must be operated at lower power levels.

While no standard method of rating printed resistors for power dissipation has yet been established sufficient data are available for a preliminary evaluation for carbon resistors on steatite. Typical results of an intermittent load test on 100,000 ohm carbon resistors 0.002 in. thick and 0.038 sq in. area (0.1 in. by 0.38 in.) painted on steatite were obtained by operating the resistors for 200 hours at loads of 0.25, 0.50 and 1 watt respectively. As a control, commercial fixed composition 0.25-watt and 0.50-watt carbon resistors were also subjected to the same loads. The curves show clearly that printed resistors perform very well compared to fixed composition resistors. Although the resistance of the printed resistors decreases 3 to 5 percent it soon stabilizes at a constant value.

Typical results of another determination of power dissipation were obtained by increasing the current through two 1,500 ohm resistors (one printed and one 0.25-watt fixed composition resistor), until they failed. The current was increased in small steps and allowed to stabilize at each value before going to the next. Both resistors withstood 20 milliamperes (0.6 watt) before any effective change in resistance took place. Further increase in current caused both to increase in resistance rapidly, peaking at approximately 37 milliamperes and then

decreasing. It is important to note that the printed resistor opened on excess current whereas the fixed composition resistor decreased in value. The opening of the printed resistor under excess load may be a desirable property, as it will not sustain heavy overload currents with the consequent damaging of other parts of the circuit.

Since the size of the printed resistors is not standard, it is not practical to specify their power rating in terms of watts per resistor. The rating must be specified as watts per unit of resistor area. In the first of the two tests reported above, an area of 0.038 sq in. dissipated 1 watt, giving a dissipation factor of 26 watts per sq in. while in the second test an area of 0.023 sq in. dissipated 0.6 watt giving the same dissipation factor. This factor is considered representative of average performance.

The selection of a good resistance formula requires careful attention to the character, quality and quantity of the ingredients. Examples of variations in behavior due to different formulas are more fully described in the Bureau publication, *Printed Circuit Techniques*. In brief, these indicate the possibilities of using the response characteristics of particular formulas to compensate for negative temperature response caused by other elements in the circuit, or of using the resistance-temperature characteristics as a basis of a temperature-indicating element in such a device as the radio sonde.

Inductors

Inductors having thin metallic lines on a ceramic form show very small variations in inductance with temperature. The fused-on coating being thin and somewhat elastic does not tear away from the ceramic surface when subjected to extreme temperature cycling. This is true even though the thermal expansion coefficient of the metal is greater than that of the ceramic. For all practical purposes, a combination of metal on ceramic behaves as though the expansion were due to the ceramic alone.

The high values of Q required for oscillator tank circuits can be obtained by electroplating over the printed inductor. A spiral inductor made of silver lines 0.0003 in. thick printed on

steatite had a Q of 25. Silver-plating to a thickness of 0.001 in. increased the Q to 125. Silver inductors painted on fused quartz were also developed during the war for the Signal Corps. These inductors, spirals on a flat surface, had a Q of 80 after firing. The Q was increased to between 150 and 200 by electroplating. Where inductors are printed on glass or ceramic tubes and the conductor built up by electroplating to a thick layer, Q 's of 175 to 200 are readily obtained. The effective Q of inductors painted on tube envelopes is actually lower than this because of the loading effect of the metal parts of the vacuum tube located inside the inductor.

In special cases, the Q of a solenoidal inductor on a ceramic form has been increased by grinding away the ceramic material between the conductors, leaving practically an air core inductor which is supported by a ceramic material having a low positive coefficient of thermal expansion. When used in an oscillator in combination with a capacitor having a small negative temperature coefficient, a frequency stability approaching that of quartz crystals was obtained.

The lowest frequency for which inductors may be printed is determined by the printing area available. In a limited area, the inductance may be increased by printing the inductors in multiple layers using a layer of insulation between them. The usefulness of this method is limited principally by the distributed capacity and the desired Q of the inductor.

The maximum inductance available in the usual size of plane spiral inductors without magnetic core material is of the order of 60 microhenries, usually limiting their use to frequencies above 0.5 megacycle. The feasibility of increasing the inductance by coating printed inductors with an electrically insulated magnetic paint is now being investigated at the Bureau.

The multiple layer idea mentioned above need not be restricted to inductors. Several circuits may be printed on the same plate, one above the other, by interposing a layer of lacquer or other insulation between them. The proximity of the circuits to each other must be taken into account in laying out the design so that undesirable couplings are avoided.

2. Centralab Printed Circuit Techniques⁶

An important question at this moment is "What do the basic everyday circuits look like when printed?" Both simple and complex circuits have been reduced in size and complexity of construction by the techniques (fig. 2.1), now used in manufacturing at Centralab. The lay-out in the left corner of the upper row of figures represents a simple RC coupler. Various more complicated coupling and filter circuits can be made using two or more of the units. The lay-out in the right hand corner of the top row includes two capacitors and one resistor and can be used as a diode filter. An important point to note is that the ceramic plate serves as a base for the circuit and resistors and as the dielectric for the capacitors. The illustration in the middle of the row represents an audio interstage coupler which we call the Couplate. The figures on the bottom row represent, on the left, a mechanical detail drawing of a 3-stage audio amplifier shown with tubes in place, and a photograph of obverse and reverse views of the unit; on the right a schematic drawing of the amplifier circuit. Note that the Couplate and the amplifier em-

ploy a steatite plate as a base for the circuit and resistors, and that the capacitors are thin, silvered disks of high dielectric ceramic soldered flat against the plate. These four items illustrate the two basic methods we employ at Centralab. Each has its advantages. It is important to note, however, that when a high dielectric constant plate is used for the circuit and resistor base as well as for the dielectric for the capacitors, a high degree of sometimes undesired coupling of components presents a problem. Where this coupling cannot be minimized to a negligible effect by proper spacing, lay-out and other expedients, it becomes necessary to use the method illustrated with the Couplate and amplifier, that is, attaching wafer-thin ceramic capacitor disks separately to a steatite plate having a low K instead of a high K.

Together with a general idea of the appearance of some commercial applications of printed circuits, we will attempt to answer another question arising in your mind, that is, "How do we manufacture printed circuits at Centralab?" Starting with a schematic drawing of the circuit, the shape and size of a base plate is determined, and a layout drawing is made (fig.

⁶ By A. S. Khouri, Centralab Division of Globe-Union, Inc., Milwaukee, Wis.

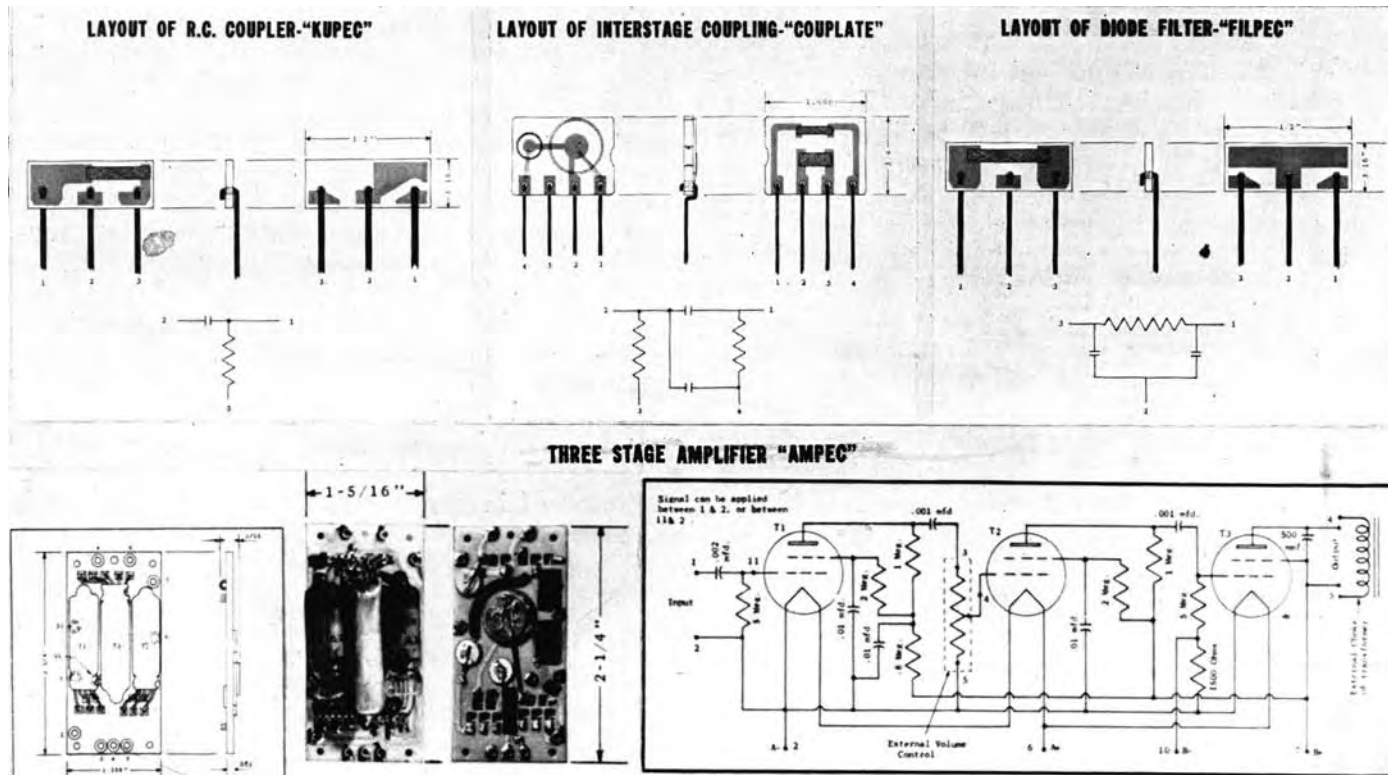

FIGURE 2.1. Examples of techniques used in printed circuits.

2.2). The lay-out drawing is accurately made to enlarged scale and photographed. From the lay-out photographs, which are reduced to actual size, screens are made which are used to apply the circuitry and resistors, as shown in the upper right corner of the photo. A silver paint used for the circuitry is fired at approximately 1,400° F. to bond it to the ceramic and to render it conductive. For the resistors, a carbon-resin dispersion is used which is baked at a moderate temperature to stabilize it against the effects of mechanical abrasion and humidity. After resistors are applied, wire leads and capacitors, if needed, are soldered to the plate to complete the assembly. A phenolic coating is used to provide insulation and additional protection against humidity and abrasion.

For a simple RC circuit (fig. 2.3), a high K

base is used as the dielectric for the capacitor. Silver and resistor screening are done in the same manner as illustrated before. However, it is unnecessary to attach external capacitors since they are included as an integral part of the unit in this design. If this circuit had been more complex and intercoupling of components had to be reduced to a minimum, then it would have been preferable to use a steatite base with wafer-type capacitors attached separately. In either case, the ceramics used for the base plate and the capacitors are dense bodies, impervious to moisture, and have excellent dielectric properties.

How these ceramics are made is another question, since it is a science all its own. In producing either steatite or high K ceramic, careful laboratory control precedes all operations such as mixing, molding, and firing.

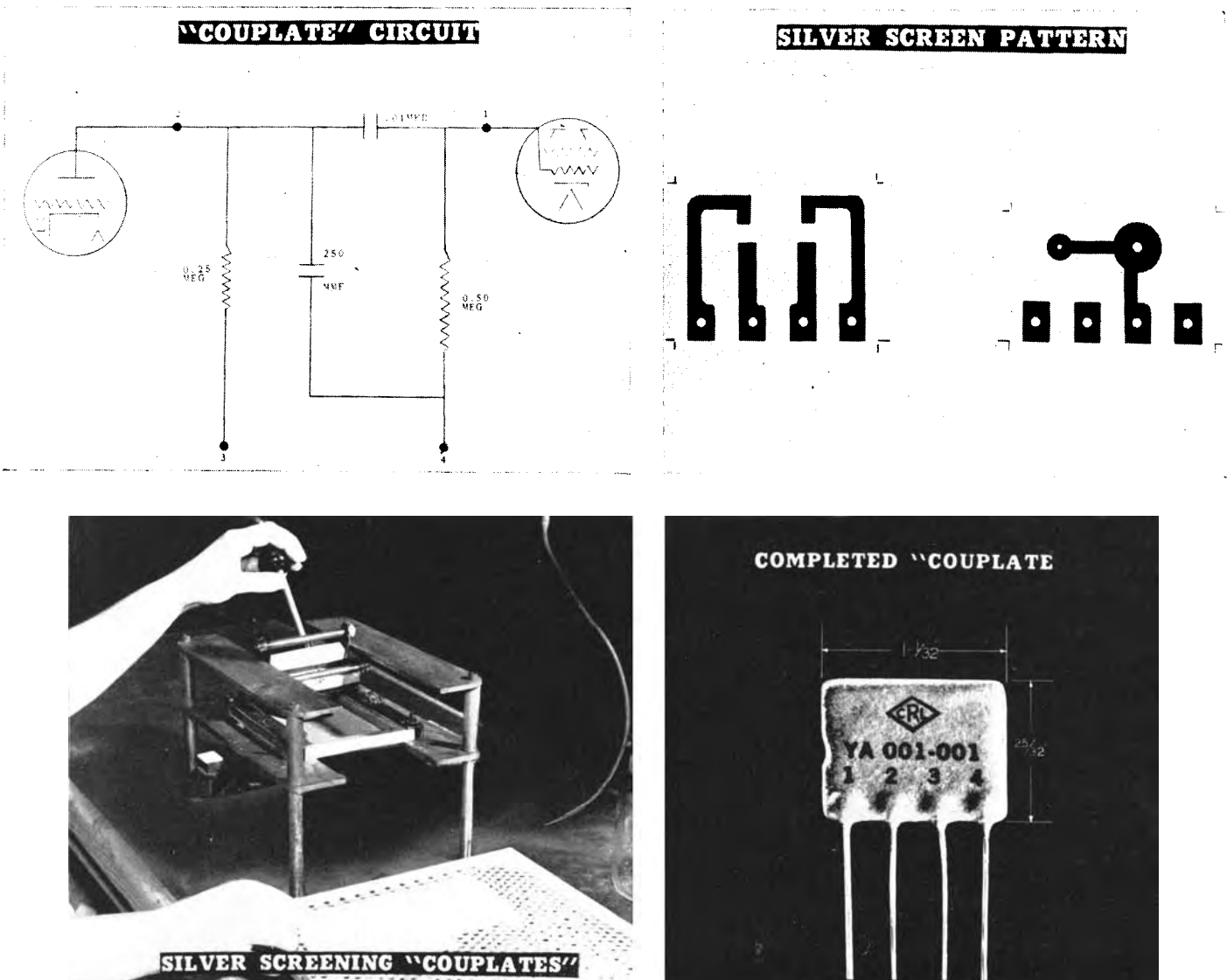

FIGURE 2.2. Steps used in manufacturing the "Couplate."

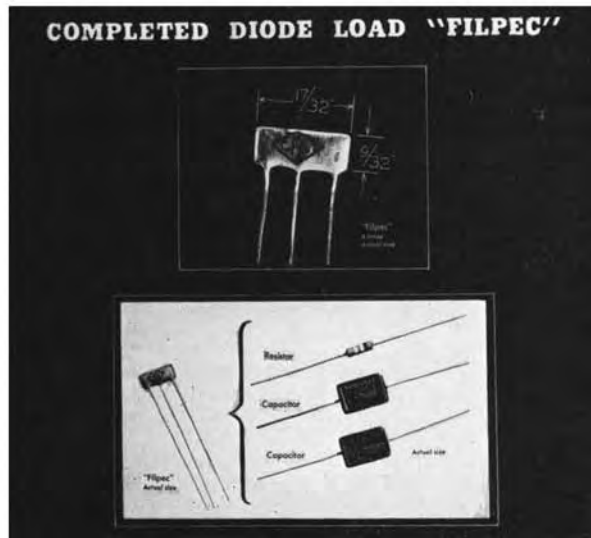
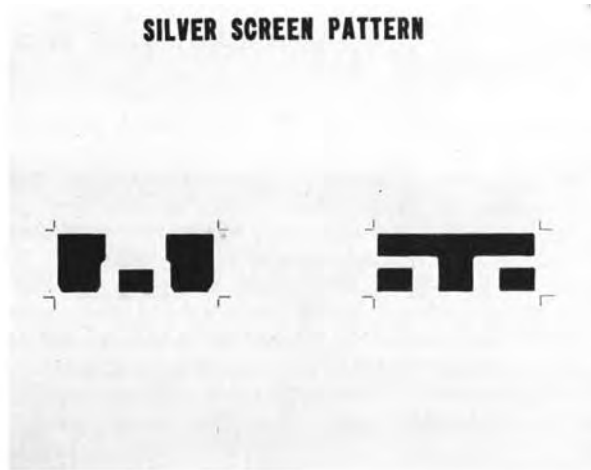
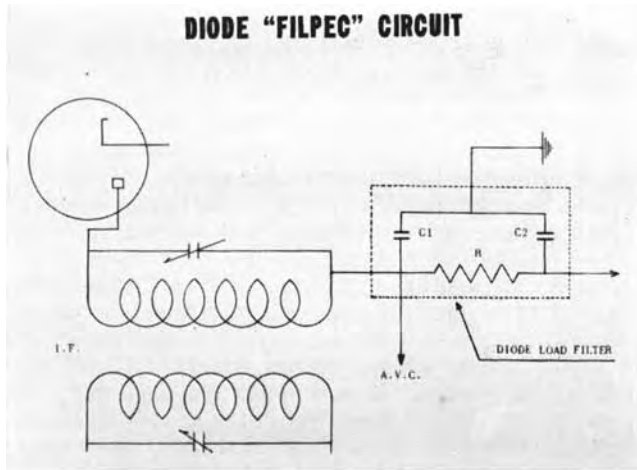

FIGURE 2.3. Steps in the manufacture of a simple RC circuit utilizing a high K ceramic base.

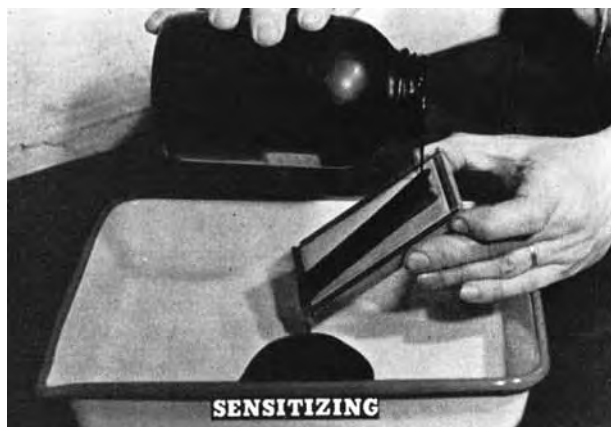

FIGURE 2.4. Steps used in preparing a screen stencil.

TABLE 2.1.—*Electrical characteristics of printed resistors*
 Example: 1 Megohm Resistor, 1/4 in. × 5/64 in.

	Humidity	Load life	Noise	Voltage coefficient
Duration and type of test	96 hours at 90%-95% relative humidity, and 40° C.	1,000 hr. intermittent (1½ hr. on, ½ hr. off). Total power dissipated 0.5 watt.		
Change immediately following test	+11%	-4.7%	4 db over equivalent composition type resistor.	0.007% per volt.
Permanent change following test	-1%			

The screens used to deposit the circuit pattern and the resistors are an important part of printed circuit equipment, and their manufacture requires considerable skill, especially for small and intricate lay-outs such as (fig. 2.4). Either silk or steel mesh screen is used. The choice depends on first cost, expected life, and quality of work. After a photosensitive emulsion is applied to the surface of the screen it is exposed to light against the photographic positive of the circuit lay-out. After washing the unexposed sections of the screen it is checked for accuracy and is then ready for use.

In order to deposit the circuit pattern or the resistors, a small amount of paint is poured over the screen and a rubber squeegee moved over the surface of the screen forces paint through the pattern openings onto the ceramic plate below.

Let us examine each of the four types of circuit components that can be made by our printed circuit technique in order to determine what these printed circuits can do and how they perform.

The conductors of "wires" are silver normally applied in widths from 0.010 in. to 0.060 in. and approximately 0.003 in. thick. A 1-in. length of conductor 0.030 in. wide will have a resistance of approximately 0.1 ohm. Humidity, load life, noise, and voltage coefficient data for a 1 megohm resistor 1/4 in. long and 5/64 in. wide may be seen in table 2.1.

The ceramic dielectrics used for the printed circuit capacitors have a number of important characteristics. Of first importance is the simple parallel plate construction which allows the capacitors to be made wafer thin so that they can be mounted flat against the printed circuit plate, retaining the two dimensional nature of the circuit and resistors. Typical temperature coefficient and ageing curves are also shown (fig. 2.5).

Inductances are applied either as spiral conductors on a flat surface, the maximum inductance practical to obtain in this manner being approximately 0.1 microhenry with a Q of 150, or as parallel lines having lower inductance but higher Q. In general, resonant circuits can be handled over the range from 25 to 509 Mc. It is important to note, since the ceramics used

have a temperature coefficient of linear expansion one-half or less than that of good metallic conductors, that an inductance which is bonded to the ceramic and constrained to expand with the ceramic base will have at least half the temperature coefficient of inductance of a similar, form-wound inductance. Also, this type of inductance has greater stability when exposed to repeated temperature cyclings than it is possible to obtain with either air or form-wound types.

Wherever it is desired to miniaturize a circuit, printed circuit techniques should be considered. For instance, it is possible to make a printed circuit having 15 capacitors and 15 resistors, or more, a total of 30 components, and associated wiring, on a plate 3/4 sq in. in area and 1/16 in. thick. Uniformity in performance and appearance of printed circuits produced in quantity is an important advantage to con-

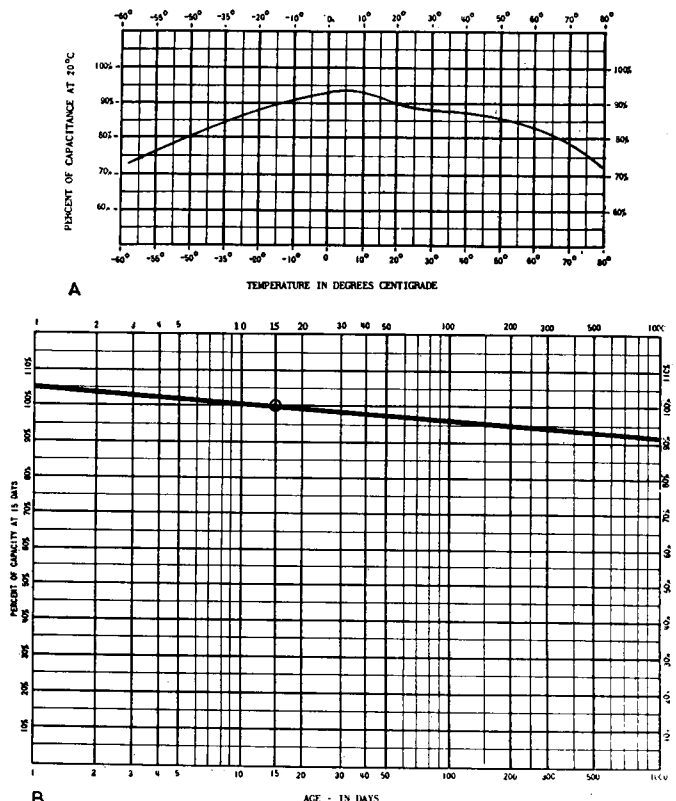

FIGURE 2.5. *Important characteristics of ceramic dielectrics used for printed circuit capacitors.*

A, typical temperature-capacity curve; B, typical aging curve.



FIGURE 2.6. Three-stage miniature amplifier showing various uses.

sider. Since all components are integrally bonded to the base plate, there can be no movement of parts relative to one another due to vibration or shock. Because of the dense nature of steatite and the ceramics used for capacitors, printed circuits are impervious to the effects of high humidity, and consequently, they should be useful in equipment destined for tropical use.

Circuits which can be treated as a unit lend themselves ideally to printed circuit techniques. In this case the circuit can be molded or potted as a unit section and provided with plug connections to the remainder of the circuit. Servicing them becomes a matter of locating the faulty section and plugging in a new unit.

A single three-stage miniature amplifier, mass produced at low cost, can be used in various applications. It can be used wherever a small "packaged amplifier" is needed such as in a stethoscope, hearing aid, pocket signal chaser, or pocket transceiver (fig. 2.6).

There is no question of greater importance to the prospective commercial user of printed

circuits than that of cost. At the present time printed circuits are competitive with and sometimes cheaper than circuits using standard components, providing, the intangible considerations such as savings in labor, wiring mistakes, purchasing, inventory and stock handling, are given their proper weight. The arithmetic illustrating the economics involved for the Couplate, a single component with 4 leads replacing 4 separate components with 8 leads, is shown in simple tabular form (table 2.2). A similar analysis can be made for any of the other printed circuit items discussed in this paper.

TABLE 2.2.—Printed electronic circuit costs
By comparative ratio computed from averaged cost analyses supplied by Couplate users

ORDINARY COMPONENTS		COUPLATE EQUIVALENT	
	<i>Index</i>		<i>Index</i>
1. 4 Separate components	9.0	1. Multiunit component	10.0
2. 8 Soldered joints	2.0	2. 4 Soldered joints	1.0
3. Wiring mistakes	1.5	3. Wiring mistakes	0.75
4. Purchasing	1.0	4. Purchasing	0.5
5. Inventory, storage, and stock handling	1.0	5. Inventory, storage, and stock handling	0.5
Total	14.5	Total	12.75

3. Conductive Silver Preparations⁷

Before describing the uses of the various silver preparations suitable for printed circuits, it might be wise to briefly outline their compositions and properties. There are available for general use two distinct types of preparations, namely: The air-set or low temperature bake compositions and the fired-on compositions.

The air-set or low temperature bake compositions are intended primarily for application to phenolics and practically all other plastics, as well as paper, wood, leather, and cloth, or other base materials which can be subjected to temperatures not exceeding 200° F, or merely air dried, to obtain the necessary bond of the conductive film to the material to which it is applied.

These compositions are paints consisting of a binder, a thinner, and a conductive silver powder which is thoroughly dispersed in the system by roll milling, ball milling, or some similar method. When applied in a thin film, even though the conductive metal particles are surrounded by an organic binder, it is possible to obtain coatings having fairly low electrical resistance. When this type composition is air dried or baked, the thinner is evaporated and the binder becomes somewhat hard, or is set, thereby bonding the particles of silver together and also to the material to which it has been applied. The form of binder and thinner incorporated in the system determines whether it is to be air dried or whether it is to be baked to obtain the greatest adherence and lowest electrical resistance. Materials which are baked on result in coatings which will have somewhat lower electrical resistance and harder, more scratch resistant, surfaces.

The fired-on compositions require firing at temperatures ranging from 850° to 1,300° F and are intended for application to ceramic base materials, such as steatite, porcelain, titanates, and glass.

The fired-on compositions or preparations are similar to the air-set or low-bake temperature preparations, except that in addition to silver powder, binder, and thinner, a ceramic flux, which is no more than a low melting, finely divided glass, is also incorporated in the system.

When the thin deposited film of composition is subjected to the elevated temperature of the firing operation, several changes take place as the temperature increases. First, the volatile thinners evaporate and leave the system. Next, the binder, present merely to produce a hard,

unfired or dry film, burns out as the temperature of the furnace is increased. Finally, the flux, or the low-melting powdered glass, fuses, and after the peak of the firing cycle is reached and the temperature of the furnace is decreased, the fine particles of silver are found to be firmly imbedded in the fused flux which, in turn, is firmly bonded to the base material.

Whenever the base material permits, the use of fired-on type of coatings are recommended. It can readily be seen that the adherence of the fired-on type is far superior to the adherence obtained when the air dry or low temperature bake preparations are used. The fired-on compositions result in a metallic film which is about 90 to 95 percent pure silver, while the air-dry or baking coatings when dry, or after baking, result in a film which is made up, to a great extent, of more or less nonconductive, organic binders. The fired-on materials have much greater electrical conductivity, usually desirable and sometimes a necessity.

It is sometimes desirable to put a thin film of electroplated copper over the conductive silver film. In this case, it is necessary to use a silver composition which has been formulated so as to withstand the effects of the acid copper bath.

One might wonder why a metal as costly as silver is used in these formulations, when other much cheaper metallic powders, such as copper, aluminum, etc., are available in a similar powder form which would be compatible with the same binders and thinners, and are almost as conductive as silver. The use of silver can be appreciated when it is realized that almost all films formed with powdered metals oxidize readily and are quickly attacked in contaminated atmospheres. Silver is one of the few metals that has the faculty of being highly conductive in several of its forms, including oxide or sulfide. Copper and aluminum, unfortunately, do not have this quality. The oxides and sulfides of these metals are very poor conductors, more or less eliminating their use in conductive coatings.

Both the air-dry or low-temperature bake and the fired-on type conductive coatings are formulated to be applied to the base material by any one of the conventional means of application. The preparations may be applied by dipping, brushing, spraying, or the squeegee or silk screen stencil process. The size and shape of the object to be coated and the area to be covered will determine the method to be used. Whenever possible, we recommend the squeegee process. It has been proven that when

⁷ By W. V. Patton, ceramic division, E. I. duPont de Nemours and Co., Inc., Electrochemicals Department, Perth Amboy, N. J.

this method of deposition is used, a uniform thickness is obtained, and the coating of a specific area may be accomplished with less equipment and at a greater speed. Also, since no material is lost due to overspray, it is more economical. This method also lends itself to mechanization.

To make possible these various means of application, it is necessary to vary the vehicle incorporated in the composition, so as to result in finished preparations having the proper viscosity and drying time for any specific use.

After the silver composition has been deposited on the base material by the desired means, one of the most important steps in this metallizing process is encountered. If the material is not dried thoroughly or baked at a high enough temperature for the required length of time, the full bonding properties of the organic binder are not obtained and the adherence of the metallic coating to the base material will be poor. In addition to this, some oils or similar materials may remain on the surface of the film and satisfactory electroplating cannot be accomplished. The reverse of this condition is also harmful. Drying or baking at higher temperatures than recommended will usually cause some of the organic binder to be burned out resulting in a poor bond.

To obtain best results with the fired-on preparations on steatite or porcelain, both glazed and unglazed, the recommended firing temperature and cycle must be adhered to. It has been found that in most cases a peak temperature of 1,220° to 1,300° F, using a cycle of 6 hours to reach this peak, will give the utmost in regard to bond of the coating to the ceramic.

For this firing operation a periodic furnace is usually used, but a conventional type decorating lehr or a continuous belt type furnace can be used with excellent results. In all cases, cycle and temperature must be regulated according to the kiln load and size of objects, as well as other operating conditions.

On glass, a firing temperature of 1,000° to 1,050° F, for soft glass and 1,100° to 1,200° F, for Pyrex or other heat resistant glass is recommended. Best results can be obtained with the usual glass firing lehr, but a periodic furnace may be used. The firing time will depend upon the equipment used, kiln load, size and shape of object and annealing time required for the particular type glass used.

For some applications such as on glass, steatite and other ceramics, it is necessary to solder leads or contacts to the silvered surface. It is possible to solder directly to the fired silver surface, but if the surface of the coating is first

burnished slightly, it will be found that the solder will more readily wet the silver.

When using the air-set or low-temperature bake type silver preparations in printed circuit work it is usually necessary to copper plate the dried coating so that the desired conductivity may be obtained. When using the fired-on coatings, it is sometimes desirable to copper plate, especially if the particular design of the circuit requires that many soldered connections be made to the fired film. In this case, the copper plating serves as a protective coating and prevents injury or rupture of the connection by the heat of the soldering operation in conjunction with the action of the solder.

Up to this point, facts concerning the composition, properties, and method of applying the various silver preparations have been mentioned. The various possible uses and advantages offered by these materials in printed circuit work will now be briefly outlined. Because of the versatility and flexibility of conductive silver preparations, mixtures are now available which make possible the application of printed circuits to practically any base material by any desired means. This fact permits the use of such inexpensive materials as fiberboard, plastics of all kinds, as well as the various ceramic materials. Hence, it is possible to use this means to wire (in addition to radio receivers and transmitters) electrical toys, games, musical instruments, switchboards, electrical measuring instruments, and any other unit whose components are usually connected by the conventional wire and soldered connections.

There are those who are somewhat concerned as to the use of silver, because of the cost of this precious metal. It has been determined that the cost of the conductive silver preparation is somewhat less than that of the copper wire and solder it would replace for the wiring of a typical circuit. The saving in labor and time should also be considered in the overall cost comparison. It should also be remembered that each printed circuit is an exact duplicate of the master pattern and there would be no rejects due to human error. In most cases this would result in further savings as it would not be necessary to have as rigid inspection facilities as is required for conventional wiring. It will also serve as a means of forever eliminating poorly soldered joints and connections.

Although the economy of printed circuits is one of its most appealing features, there are many others which should not be overlooked; foremost among these is the high rate of production which is possible. By using a suitable conductive silver preparation in conjunction

with the squeegee application process, with only slight mechanization, it is possible to perform the principal circuit wiring at the rate of at least 50 units per minute with an active area coverage of approximately 4 square feet per troy ounce of silver composition.

Of equal importance is the exceedingly small size of the unit. Because of the extreme thinness of the silver lines it is not necessary to confine the circuit to the two sides of one base, but it is possible to build up layers of the individual units into one elaborate circuit or series of circuits.

At the present time, work is progressing on

the use of conductive silver preparations in forming inductances and tuning devices on small flat plates, vacuum tubes, and other bases. When these are perfected, it will be possible to eliminate all wiring and other conventional components.

The du Pont company is continuously carrying on the development of new formulations and the improvement of existing silver preparations. In addition, technical service facilities are available to manufacturers desiring assistance in setting up equipment and selecting the proper silver preparations for printed circuit work and related applications.

4. Printed Resistors⁸

The interest aroused by printed circuit development has assumed such proportions that a more detailed consideration of its component elements is warranted. One of the primary circuit elements actually printed is the resistor, whose importance is emphasized by the many difficult requirements it must meet. While in appearance it is simplicity itself, some of its behavior patterns are extremely complex and unorthodox. This type of resistor has a considerable history in back of it and production methods and product have been developed to a high degree of perfection.

It is proposed first to review briefly the more modern methods for their mass production and then discuss a few of their more important characteristics.

Definition

The subject matter under discussion should be clearly defined. The phrase printed resistors (1) indicates a method for producing resistors, namely, by a printing process, and (2) implies that the resistor is a film—since any printing process produces a mark which is a film. However, there are many ways of obtaining a film resistor—for example, evaporation, spraying, printing, dipping, pyrolysis, painting, etc. We will therefore employ the term printed resistor in the usual sense as a film resistor applied by any means.

There are many different types of films: (1) Metallic films such as are produced by evaporation of metals, (2) films made from metallic compounds, such as phosphates, (3)

carbon films produced by pyrolysis, (4) films in which the conductor is graphite or carbon mixed in a resinous binder. It is the last type of film resistor which is the subject of this paper.

Description

Graphitic or carbon resistance films have been and are being applied commercially on a large scale to various types of insulating bases such as glass, ceramic, paper and phenolic sheets. The supporting bases may be cylindrical or flat. Typical of the applications of such films is their use as resistance elements for low and medium power composition resistors and for volume controls. Although the commercial objective up to now has been to produce at any one time large numbers of separate individual resistors of a given value, the methods developed lend themselves to production of a number of resistors of different values on a single base.

Resistance Films

A brief review of some modern techniques in commercial practice for printing resistor films on various types of bases, and a few illustrations of the types of films so produced will reveal potentialities for use in printed circuits on a large scale.⁹

⁸ By Jesse Marsten, vice president, and Alexander L. Pugh, Jr., research engineer; International Resistance Co., Philadelphia, Pa.

⁹ *Editors Note:* See Operating Characteristics of Film Resistors by Jesse Marsten and Alexander L. Pugh, Jr. Tele-Tech, March 1948, p. 46, for other applications.

Resistance Films on Glass

Printed resistance films are applied to clear glass rod or tubing in a process in which the glass rod or tube is drawn continuously on a machine. As it is drawn, a liquid resistive film is applied on the outside of the glass base. As with all films of this character, the resistivity of the film in the liquid phase is extremely high, but as the coated glass tube or rod continues on its journey through the machine, it is converted to a tough, hard film of the desired resistivity. This film is continuously measured and its tolerance indicated on a limit bridge as the filament completes its passage through the machine resulting in a black-coated glass resistor. This printed resistor or film is used as the element of the so-called "filament" type composition resistors. This filament is then cut to various lengths, terminals are applied, and the assembly molded in phenolic.

The initial charge of glass from which the tube is drawn lasts for a period of 2 to 4 hours. The speed at which this resistor film is applied is 2 in. per second. For the average size composition resistor this is equivalent to four resistor elements per second. The film is made commercially in values varying between 100 ohms per inch to 100 megohms per inch. Films have been made as high as 1,000 megohms per inch. The thickness of the film depends upon resistance value and varies from 0.0004 in. for the low resistance value to 0.0002 in. for the very high values. The method of application of the film is such that a high degree of uniformity in the thickness, and therefore resistance, of the film is obtained. The important point to note is that the entire operation is mechanical and continuous and the end resistance value of every section of the rod or tube is measured during the manufacturing process. Any or all of the control factors which determine resistance value can be adjusted during the process without stopping the machine. If the resistance value wanders out of tolerance, adjustments are made and the resistance is brought back in tolerance as shown by an indicating meter. The end resistance value of the completed and assembled resistor is essentially controlled while the film is applied. Typical characteristics of printed resistors on glass are temperature coefficients at 0° to 100° C of —0.02 percent per °C in the 1,000 ohm range to —0.05 percent per °C in the 10 megohm range; temperature coefficients at 0° to —55° C of —0.02 percent per °C in 1,000 ohm range, to 0.03 percent per °C in the 10 megohm range; voltage coefficients of —0.004 percent per volt in the 1,000 ohm range, —0.035 percent per volt in the 10 megohm range; noise level at rated loads of 0.25 microvolts per volt in the

1,000 ohm range and 3.5 microvolts per volt in the 10 megohm range.

Resistance Films on Ceramic

Printed resistance films are also applied to ceramic bodies. Unlike the film on glass each resistor is handled individually. The film is applied in a spiral line on the ceramic tube. Low resistance terminations are applied at the ends. The resistors are then cured to obtain the desired resistivity. The film is also applied as a solid coating for high frequency applications. These resistors are frequently used immersed in oil or water, which imposes a severe requirement on the adhesion characteristics of the film to ceramic. The adhesion characteristics of this film to ceramic are sufficiently tenacious to meet this service condition. Typical characteristics are voltage coefficients of —0.002 percent to —0.04 percent per volt per in. and temperature coefficient of —0.005 percent to —0.075 percent per ° C.

Linear Resistance Film on Phenolic Sheet

Many applications require resistors having unusual shapes. To meet such requirements a uniform resistance film is applied to phenolic sheets and these sheets processed to meet the specific needs. In this operation phenolic sheets 4 to 5 feet long and of the appropriate width and thickness, are fed by conveyor to a mechanism which deposits a given quantity of the resistive solution on the sheet. The printed sheet goes through its curing stages to produce a hard durable film having a predetermined resistance value which varies linearly with length in any direction. Resistance elements are punched out in a die to meet the particular mechanical and electrical specifications required. Some of the different shapes currently produced are used as attenuators for wave guides, strain gages, etc. Printed concentric disk resistors used as coaxial line terminations are produced from a printed sheet such as previously described. Silver annular terminals are sprayed on the disks.

Phenolic sheet with printed resistance film is also made with silver conductive terminations, applied simultaneously in one operation with the resistance film or separately by spraying. Individual printed resistors with silver conductive end terminals are then made by punching out elements to size. As in the case of applying a film to glass, the operation is a continuous one. The application of resistance material being a mechanical one, a high degree of uniformity in resistance value is possible. A resistance element punched out of a strip 1½ in. wide in any position or direction will not vary more than ±25 percent from the

mean. Closer tolerances may be obtained by additional processing. The rate at which the sheet is printed is one inch per second. The thickness of the film varies between approximately 0.0004 in. to 0.0012 in. depending upon resistance values, the lower resistance films being thicker. Using as a standard a unit 1 in. long and 1/16 in. wide, resistance values can be produced between approximately 500 ohms and 10 megohms.

Nonlinear Resistance Film on Phenolic Sheet

There are some applications where resistance elements are required whose resistance is not a linear function of length. The most notable illustration of this is that of the tone control and volume control in radio receivers. A phenolic strip, conveyor-fed, on which four contiguous resistance films are continuously and simultaneously printed, each film having a different specific resistivity is used for this purpose. A horseshoe shaped resistance element punched from this strip would show a nonlinear resistance-rotation curve. By suitable choice of calibrated resistance inks and by appropriate design of printing system, a resistance film obeying almost any resistance-rotation law can be produced.

Typical performance characteristics of printed resistor films on phenolic sheet are voltage coefficients of -0.004 percent per volt per inch to -0.02 percent per volt per inch and temperature coefficients of 0.015 percent to 0.1 percent per $^{\circ}\text{C}$ from 0° to 100°C and 0.06 percent to 0.3 percent per $^{\circ}\text{C}$ from 0° to -50°C .

The resistor film produced is hard enough to withstand the wearing action of a smooth sliding contactor exerting 4 to 6 grams pressure for 50,000 cycles of operation without damage to its surface or without changing resistance value more than 15 percent.

Printed Tape Resistor

Resistance film has also been printed on a flexible base Cellophane tape about $\frac{1}{2}$ in. wide and 0.001 in. thick is fed into a printer from a reel containing several hundred feet of tape. The resistance material is printed in a line which may vary in width from $\frac{1}{32}$ in. to $\frac{1}{8}$ in. depending upon the requirements. Wider bands may also be applied. As with the filament on glass, the entire operation is a continuous unbroken chain, feeding tape into printer, printing resistance film, curing of film, measuring of final resistance value and rereeling. The speed of travel through the printer is 1 inch per second. Resistance values capable of being printed vary from 500 ohms to 1.0

megohm per inch. The film is mechanically strong. It adheres tenaciously to the tape and will not flake off. It has flexibility and can stand a 160° bend without any cracking or checking.

Application To Printed Circuits

Multiple Printed Resistors

The mass production techniques for printing resistor films that have been described are in everyday commercial use. It is a short step to apply these techniques to printed circuits by printing multiple resistance films, which will yield simultaneously a number of different valued resistors on one base. A phenolic sheet, conveyor-fed to a printer, on which are printed five independent resistance lines illustrates this (fig. 4.1A). Such lines may be equal in width or vary as determined by electrical requirements. From these strips, by suitable design of punch and die, a bank of resistors can be punched out and all interconnections may be applied as shown. Size, shape, number of independent resistors, and interconnections can be varied at will, within the limitations of the printing device and the dimensions of the sheet.

Punched Printed Circuits

Complete resistor complements of circuits with associated wiring can be printed and punched in one operation ready for use. The resistor complement of a particular two-stage amplifier consists of five units, three 5-megohm units and two 2-megohm units. The entire resistor system and interconnections can be produced from a resistor strip (fig. 4.1B). The resistance film is printed together with the silver conducting terminations by methods previously described. By use of dies a printed element with all the interconnections is obtained with holes to which the other circuit elements can be eyeletted or rivetted. Provision can also be made in proper designed openings to enclose other components such as capacitors or tubes.

Discussion

The printed resistor under discussion is a member of the general class of so-called "composition resistors." By and large, all these resistors, whether of the solid body or film type, are made in the same general way although there are wide variations in materials, formulations, details of procedure, etc. Resistors of this class are made by preparing a homogeneous mix of a conductor, generally graphitic or carbonaceous, or both, with a resinous binder and

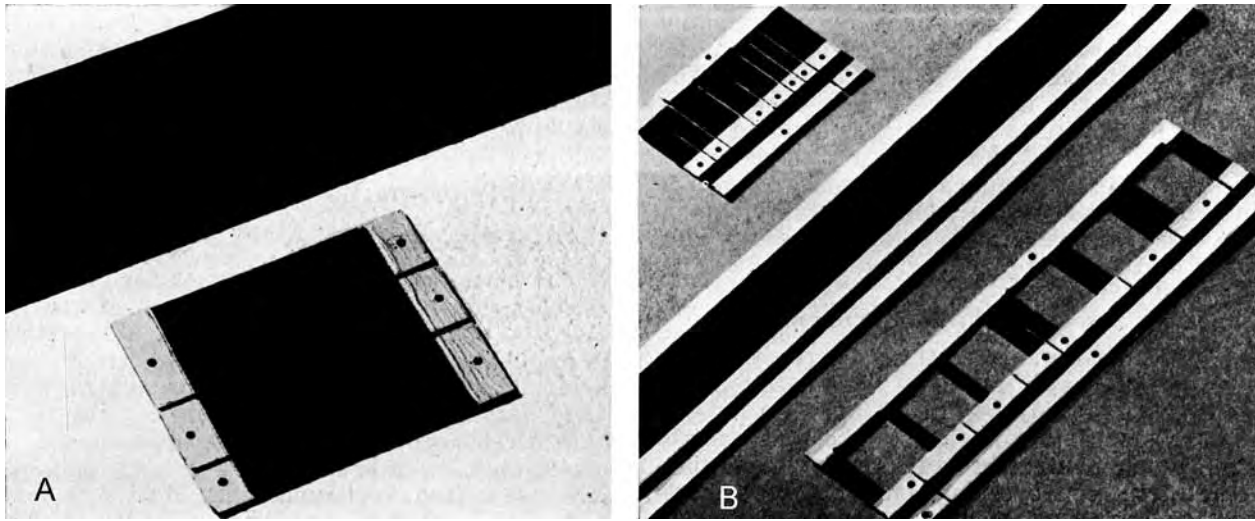

FIGURE 4.1.

A, Phenolic sheet with five independent resistance lines. B, Punched-printed resistor complements on phenolic base.

sometimes with filler. In the case of the solid resistor the binder is a resinous molding powder. In the case of the printed film resistor, the resin is in the form of a varnish. In both cases a curing operation is essential to harden the mass or film. Prior to the final polymerizing operation the mixtures have infinite or very high resistance. This operation, involving temperatures or pressure, or both, shrinks and fuses the resistive composition into a tough hard body or film. The resulting structure then consists of conducting particles held together by a dielectric binder. Resistance values are controlled by modifying the ratio of dielectric to conductor. The higher this ratio, the higher the resistance value. The conducting particles make contact with each other under the pressure that exists in the structure. Since most of the resistivity of the device is a summation of the contact resistances between particles, whatever alters the contact pressure will affect the resistivity. Many of the unorthodox performance characteristics of this type of resistor are a direct result of the structure of this device.

Required Characteristics

The characteristics that are usually desired in a resistor can be secured individually but some properties appear to be conflicting when they are wanted simultaneously. For example: The size for a given power rating might be reduced but the noise, voltage coefficient, temperature rise, or some other property might then be affected. For this reason all resistors are compromises. To be generally acceptable printed resistors should meet the following mechanical requirements: (1) Adhesion of film to

base should be good; (2) film should be hard and resistant to abrasion; (3) film should not be brittle; (4) film should be flexible; (5) thermal characteristics of film must not deviate too greatly from that of the base.

All these requirements are dictated by the obvious consideration that unless they are met, normal use conditions such as handling, and environmental factors such as humidity and temperature, will result in injury of the film with resultant deterioration of the resistor. Most of these requirements are so obvious as to be axiomatic. However, a brief discussion of some of them is in order.

The requirements of hardness and nonbrittleness are dictated by use conditions. Storage of parts, handling in storerooms and on factory assembly lines subject these units to considerable abuse. The films must be tough enough to withstand such usage. Even if the film is protected by a varnish coating, this coating must then be capable of meeting these requirements. Resistance of abrasion is essential in those cases where sliding contacts are used on the printed resistor, otherwise material is removed, resulting in major alteration of resistance value and deterioration of the film.

Thermal characteristics become important when the resistor is subjected to variations in temperature. If the expansion coefficients of the supporting base and film vary too widely, differential expansion takes place. If the temperature change is large the film may break or lift from the base. This can be minimized or even completely eliminated by selection of materials which adhere tenaciously to the base.

Resistors should also meet the following electrical requirements: (1) The resistance should

not change appreciably on the shelf; (2) humidity should not affect the film; (3) the film should not show polarization effects; (4) temperature coefficient should be low; (5) voltage coefficient should be low, i.e., resistance should be insensitive to voltage changes; (6) must be capable of withstanding wide variations of temperature; (7) have good high frequency characteristics; (8) operate at its rated load indefinitely without important changes in resistance values; (9) withstand vibration; (10) have low noise level; and (11) withstand effects of salt water spray.

When all of these are met, there is the last, but important, production requirement that it should be possible to produce this printed resistor economically in a wide range of resistance values.

Properties of Printed Resistors

The properties of a printed resistor are a composite of two factors, (1) the conducting film and (2) the supporting base. The properties of the conducting film in turn depend primarily upon its ingredients, their processing, and the structure of the film. The supporting base assumes a much greater importance in determining the end properties of the resistor than is normally assigned to it. A few of the more important properties will be discussed.

Power Rating and Temperature Rise

In the last analysis the rating of devices like the printed resistor is determined by long time tests. That safe rating is usually applied which insures satisfactory performance under the rated load. Obviously the temperature limitations of the resistor components are determining factors in this rating. It is therefore desirable that the temperature rise be kept as low as possible. If it can be made low enough the rating might be increased, or the resistor could be operated at higher ambient temperatures, which latter factor is becoming more important as equipment becomes smaller in size. In this connection, the supporting base plays a very important part.

This is shown in data (fig. 4.2) obtained in the course of a cooperative development program for printing resistors on vitreous dielectric bodies, conducted by the Remington Arms Co. and the International Resistance Co. Comparison was made between phenolic sheet, steatite, and the Remington Arms Co.'s vitreous dielectric, with and without printed silver inlay. The resistor dimensions were 0.040 by 0.5 in. printed on supporting bases having a projected area of 1 sq in., except in the case of the

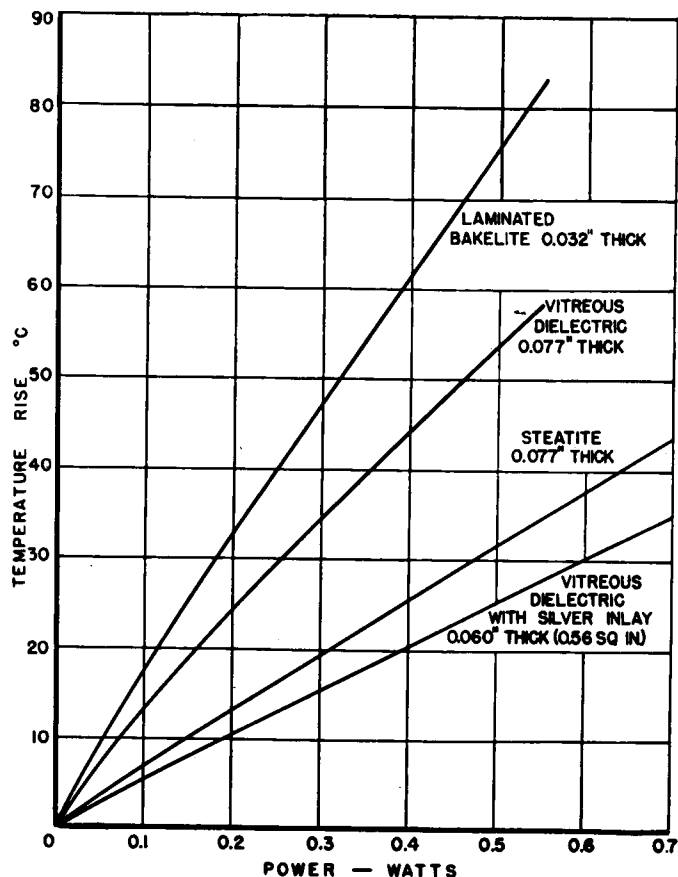

FIGURE 4.2. Temperature rise vs. power for printed resistors on various base materials.

Projected area 1 sq. in.; resistors 0.040 in. x $\frac{1}{2}$ in.

vitreous dielectric with silver inlay, which was 0.56 sq in.

The differences shown are due primarily to the differences in the thermal conductivity of the base materials. As is to be expected, the lower thermal heat conductivity of phenolic results in higher temperature rises than with ceramic. The other curves show the large differences that exist in thermal conductivity of different types of ceramics.

It should be pointed out that despite the higher temperature rise for phenolic sheets, they have proved to be a very satisfactory base for numerous reasons. The ratings and temperature requirements which would normally be assigned to a resistor of these dimensions, namely, 0.1 to 0.25 watt, are well within the temperature and life limitations of these materials. Also many applications require resistors carrying negligible power. In addition, the adhesion of printed film to phenolic is remarkably good. Another factor of importance is that the thermal properties of a phenolic are very close to those of the film. Finally, the use of phenolic lends itself readily to mass production methods.

The effect of the silver inlay in increasing the heat conductivity of the vitreous dielectric

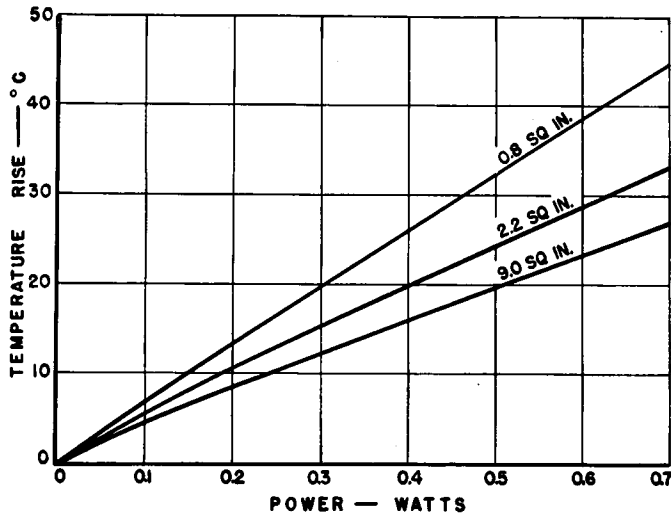

FIGURE 4.3. Temperature rise vs. power on different projected areas of base.

Steatite 0.150 in. thick; resistors 0.040 in. x ½ in.

is shown by the greatly reduced slope of its curve compared to that without the silver inlay. The silver inlay reduces the temperature rise to less than one-half that of the plain dielectric. Since the area of this plate is approximately one-half that of the others, the comparative improvement is even greater than that shown in the curve.

The area of the supporting base affects the temperature rise to a great degree (fig. 4.3). As is to be expected, enlarged base area reduces temperature, but here we run into the law of diminishing returns when dealing with one resistor. The benefit of the larger area is realized when multiple resistors are applied to the base.

Temperature Coefficient

The temperature coefficient of this class of resistors is not a constant factor. It varies with resistance value, and for a given resistance value it varies with temperature. The coefficient may even change sign at some point on the temperature scale. This anomalous behavior is due to the peculiar structure of the resistor. We are not dealing with a pure conductor, which has a positive coefficient, or a semiconductor, which has a negative coefficient. We are dealing with a conductor, (graphite or carbon, or both) which may have negative or positive coefficients, mixed in varying proportions with insulation. The supporting base is also affected by temperature. Temperature changes affect all these components differently. Stresses are set up by even small differences in coefficient of expansion between these various components. Also, contraction and expansion may affect the contact pressure between conducting particles nonlinearly for the same tem-

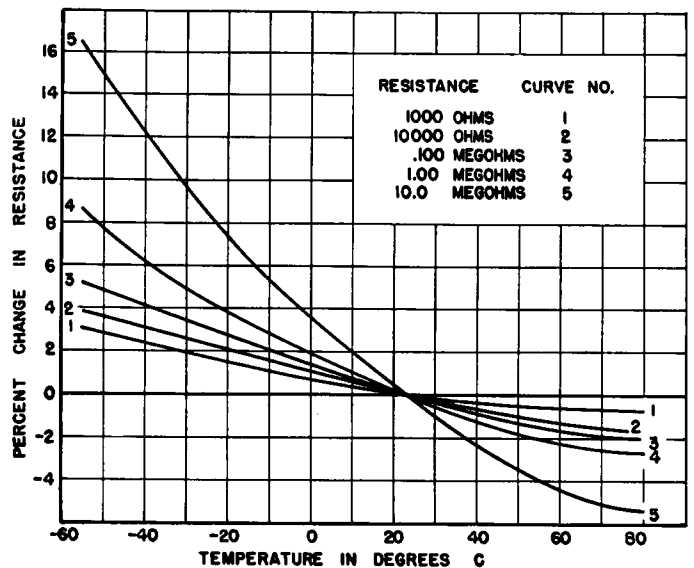

FIGURE 4.4. Temperature characteristics of resistance films of different values on phenolic base.

perature increment at different temperatures. The temperature coefficient of the conducting material itself—namely, graphite or carbon—is not the dominant factor in establishing the temperature characteristics of the resistor. Rather it is the result of all the stresses set up by differential expansion, which affects the contact pressure between conducting particles, which pressure determines the ultimate resistance and therefore temperature coefficient. As a result it is necessary to speak of temperature characteristics over a wide range of temperatures rather than temperature coefficient.

The temperature characteristics of a resistance film of different values on phenolic sheet show that the coefficient is negative but greater at lower than at higher temperatures (fig. 4.4). Also, the coefficient is greater for the higher resistance values.

The temperature characteristics of a given resistance material on phenolic and two different ceramic bodies are almost identical (fig. 4.5), indicating the supporting base in this case does not affect the characteristic appreciably.

High Frequency Characteristics

It is well known that the apparent a.c. resistance of composition resistors shows a drastic fall-off from the d.c. value as frequency increases. This is more particularly true of high resistance values. This effect, known as the "Boella effect," named after its discoverer in Italy, was further investigated in England where G. O. W. Howe proposed a theory explaining this behavior. He assumed that the resistor simulated a transmission line of half the length of the resistor, with uniformly dis-

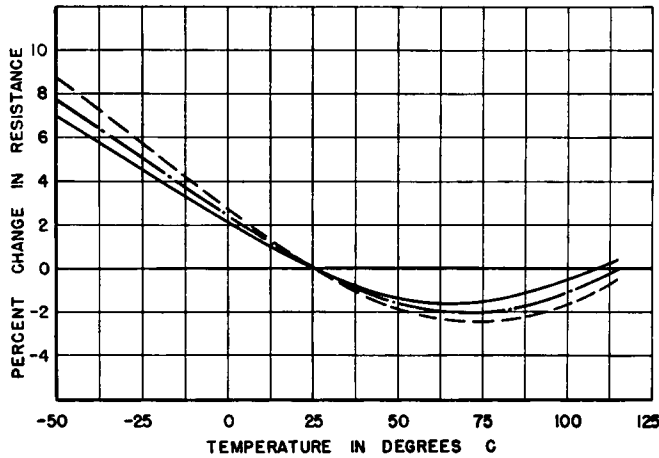

FIGURE 4.5. Temperature characteristic of a given resistance material on phenolic and two different ceramic bodies.
 — laminated phenolic base, - - - ceramic "S" base, - . . - ceramic "D" base.

tributed capacitance. In this theory he derived a universal relationship between $\frac{R_f}{R_o}$ and fR_o ,

in which the ratio of $\frac{R_f}{R_o}$ is constant for equal

products of R_o and f . (R_f is the apparent h.f. resistance at frequency f ; R_o equals d.c. resistance.) The fall-off in resistance value with increasing frequency is therefore primarily due to shunting effect of the distributed capacitance in the resistor. Many observations confirm this theory generally, although Salzberg and Miller, in a paper published in April 1939 in the RCA Review, show considerable departure at frequencies above 200 megacycles. More recently this subject has been studied by R. F. Field of the General Radio Co. In an unpublished paper, he introduced the additional consideration of dielectric loss in the distributed and lumped capacitances in Howe's artificial line, which would increase still further the fall-off in apparent a.c. resistance. The Boella effect in composition resistors of all types, including printed films, is a direct result of the resistor structure. Large numbers of conducting particles interspersed with large amount of dielectric produce capacitances and its concomitant dielectric losses which act as shunts at high frequencies. Minimum dielectric is therefore the condition for better frequency characteristics.

As a direct result of this condition, the geometry of the resistor influences the high frequency characteristics. Consider two resistors of equal length, one having twice the cross-section of the other. From a given resistance value, the smaller unit would require resistance material with the lower specific resistivity. This means less dielectric resulting in better

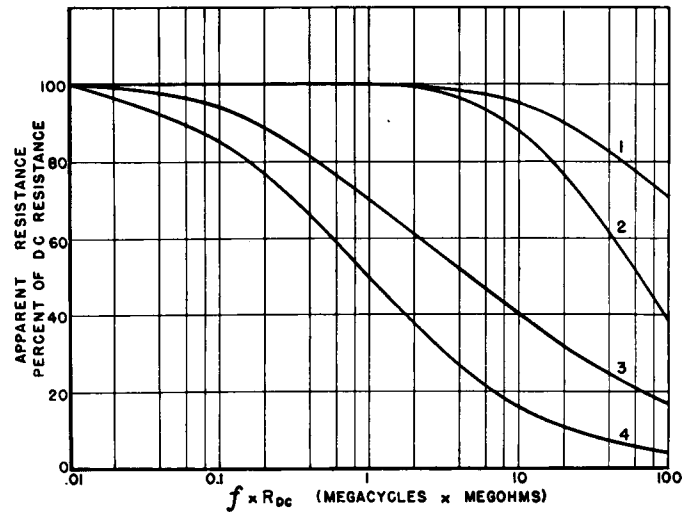

FIGURE 4.6. Frequency characteristics of different types of resistors.

(1) film type $1\frac{1}{2}$ in. long in ceramic body; (2) film type $\frac{3}{4}$ in. long in ceramic body; (3) film type $\frac{5}{7}$ in. long in molded bakelite; (4) solid rod in molded bakelite.

frequency characteristics. The condition for minimum dielectric is therefore minimum cross section of resistor. Similarly, if the area of both resistors is constant, the condition for minimum dielectric is maximum length. For best high frequency characteristics, the ratio of area to length of the resistor should be a minimum.

The printed film resistor most nearly meets both requirements established for minimum Boella effect. Its cross section is extremely small since it is a film. The film volume also being small, the dielectric mass is very low.

The most comprehensive set of high frequency measurements on composition and film type resistors have been made by D. T. Drake, Massachusetts Institute of Technology, published in Unclassified Report 520; and R. F. Field, previously mentioned. Curves representing the average performance of a number of resistors of each type (fig. 4.6) have been taken from the latter. Field states that these curves have been smoothed out and extrapolated well beyond the actual observations on the basis of the best present information. The curves are self-explanatory and also indicate the superior performance of the longer unit. Although the third curve from the top is also a film resistor, its characteristics are poor because of its encasement in molding material with large losses. For comparative purposes the h.f. characteristics of a solid type composition resistor is shown.

Voltage Coefficient

The resistance value of printed resistors is not independent of applied voltage, i.e., it does not strictly obey Ohm's law, and decreases with

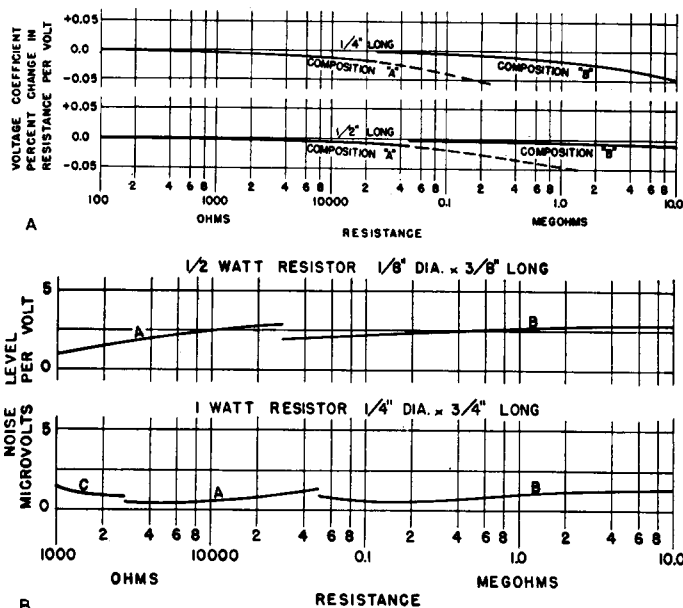

FIGURE 4.7.

A, Variations of voltage coefficient with resistance value, length of resistance path, and composition of film. B, Variation of noise in printed resistors of different composition, length and resistance values. A, B, and C are different types of compositions.

increasing voltage. This characteristic, called the "Voltage Coefficient," is a function of: (1) Composition, i.e., materials used in film; (2) resistance value; for a given type of composition and size resistor, the coefficient decreases with decreasing resistance value; (3) length of resistor; for a given type of composition and resistance value, the coefficient decreases with increasing length.

This is illustrated in measurements (fig. 4.7A) taken on resistors made with two formulas of resistance material and on two different lengths. Lower resistance values in a film resistor, for a given type of composition, implies less insulating material in the film. Greater length of resistor, for a given value, implies lower resistance per unit length and therefore less insulating material. The variation required in each of these factors to produce minimum voltage coefficient is in the direction to reduce the amount of the dielectric required.

The explanation for this is largely in the observed relationship between contact resistance between carbon particles and voltage across contacts. The contact resistance between two carbon particles is an inverse function of voltage. Since most of the resistance resides in the contacts, anything which reduces the voltage across the contact of conducting particles will reduce the voltage coefficient. Increasing the number of conducting particles is the equivalent of reduction of the amount of dielectric in the resistor, which is the condition for minimum voltage coefficient.

Noise

Noise measurements were taken substantially as outlined in JAN-R-11 specifications on printed film resistors on glass (fig. 4.7B), with variations in composition, length of resistor, and resistance value. The noise variation pattern is similar to the pattern of voltage coefficient and high frequency characteristic. All other factors being the same, noise decreases with (1) increase of resistor length, (2) decrease in voltage applied, (3) decrease in resistance value and (4) a favorable change in materials, as shown by the curves.

Christensen and Pearson reported in the Bell System Technical Journal for April 1936 that they failed to detect any noise in a solid carbon filament other than that due to thermal agitation. They concluded that most of the noise in carbon composition resistors came from the contacts between carbon particles, and that this was a function of voltage. They demonstrated that increasing the number of contacts would decrease the over-all noise. Empirical results with composition and film-type resistors confirm their conclusions.

In the type of resistor under discussion resistance is increased by adding dielectric binder. This is equivalent to reducing the contact density or the number of contacts per unit volume, and increasing the resistance of the contacts. For a given current through the resistor or a given power in the resistor, this results in greater voltage drop across each contact, which produces greater noise. As in the high frequency and voltage characteristic the condition for minimum noise is minimum dielectric in the resistor.

Many of the other characteristics of the printed resistor can be similarly explained on the basis of the composition and physical structure of the resistor. Once the materials, compositions, and physical shape of the resistor are established, these characteristics will repeat themselves uniformly and the resistor behavior can be predicted.

Conclusion

There are available methods for large scale production of printed resistors that can meet the difficult requirements imposed on them. The application of these methods to printed circuit work is one of adapting these methods to particular requirements.

The characteristics of these resistors are well known. The conditions required to produce satisfactory properties are known and by a proper choice of materials and processing most of these characteristics can be obtained.

5. Metal Films and Their Applications to the Fabrication of Resistors and Printed Circuits¹⁰

Constant research and development of components in electronics have helped tremendously not only in stabilizing over-all circuit parameters but in reduction of size. One such notable advancement was in the field of subminiature receiver and transmitter design, made possible by the development of the proximity fuze which contributed much toward the winning of the war.

Modern subminiature vacuum tubes and printed circuit techniques are now being used commercially on a large scale. However, the printed circuit can be adapted to many uses where the present stage of the art does not suffice. Thus, if the entire printed circuit could be made inorganic in nature, in order to withstand abuse at exceedingly low or high temperatures, then the scope of its use could be vastly enlarged.

Let us center our interest primarily on the resistive components ordinarily employed. Prior art discloses that organic bonds used in the fabrication of the conventional carbon resistors have a rather limited temperature range and, therefore, limit the ambient temperature under which the resistor will operate satisfactorily. It is thought, therefore, that if the same processes now used in the fabrication of "Nobleloy" metal film resistors could be adapted to the printed circuit process, a superior product would, no doubt, be the result.

Before attempting to describe a tentative metal film resistor process applicable to the present-day printed circuit technique, consider some of the processes now employed in the manufacture of "Nobleloy" X-type resistors (fig. 5.1).

The ceramic form upon which the metal is to be precipitated is composed of either pure magnesium silicate or a combination of magnesium and aluminum silicate. The former material is preferred since experiment has shown that better control of the finished product may be expected. The ceramic tube or rod is then sprayed with a solution of an especially prepared metallo-organosol of palladium, the concentration of which is carefully controlled in order to yield a unit of a given predetermined resistance value.

The metallo-organosol solution may be prepared by either of two methods—the precipitation or the fusion method. We have chosen the precipitation method because the reaction can be more carefully controlled. Partially hydro-

genated abietic acid is reacted with sodium hydroxide to form sodium resinate. The resinate thus formed is reacted with an aqueous solution of palladium chloride under very carefully controlled conditions, forming a precipitate of palladium resinate. The precipitate thus formed is washed very carefully of residue and force-dried. The dehydrated resinate is then dissolved in a balanced organic solvent of very low surface tension, forming the metallo-organosol of palladium. The above prepared solution is a very good insulator and will show no conduction prior to processing.

The processing of the coated tubes or rods consists of subjecting the units to a pyrochemical process in which the resinate is caused to revert back to the pure metal and to precipitate very slowly and evenly throughout the surface area of the ceramic form. The carbonaceous residue formed during this process is made to

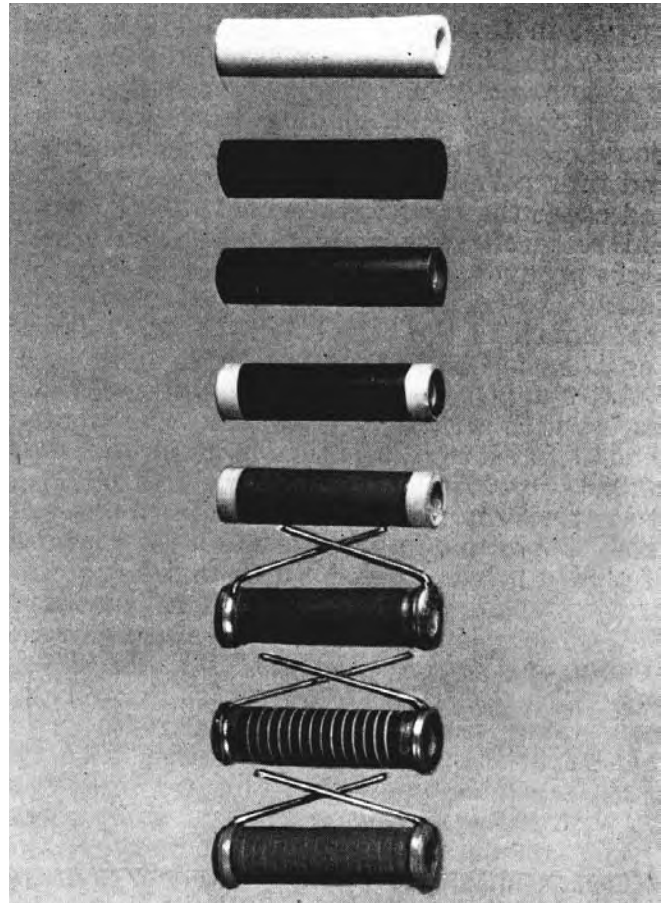

FIGURE 5.1. "Nobleloy" resistors in various stages of manufacture.

Top to bottom: Plain magnesium silicate tube; tube sprayed with metallo-organosol; metallized film after firing silver end contacts to film; vitreous enamel coating; wire terminals soldered to silver contacts; spiralled resistor to obtain required value; completed unit.

¹⁰ By J. W. Jira, executive vice president, Continental Carbon, Inc., Cleveland, Ohio.

combine with atmospheric oxygen forming carbon monoxide which, in turn, is oxidized to form carbon dioxide gas, which is easily removed. The affinity of the metal film to the ceramic form is such that mechanical grinding is the only means by which it may be effectively removed.

Electrical contact to the resistive element is made by coating each end with a silver enamel, which, after firing, produces a very tough metal surface to which wire leads are soldered. Prior to the soldering operation, however, comes the vitreous enameling process, upon which the success of the metal film resistor hinges. This operation not only protects the metal film from mechanical abrasion but also from atmospheric influences, thus causing the unit to display an ultrastable shelf life or, in other words, excellent permanency in ohmic resistance. Also, the vitrified coating greatly increases the wattage rating by permitting higher surface temperatures, normally not possible when employing organic coatings.

The use of a vitreous enamel over the metallic film appeared simple enough from the outset, but as time went on insurmountable difficulties appeared. The standard enamels were not low enough in fusion; their high alkalinity would attack the film at temperatures of fusion and thus completely change its electrical characteristics; crazing and spalling when under load would cause cracks to appear in the fused coat and thus permit entrance of outside influences and cause the resistance value to drift. A special research program by Continental's engineers produced an enamel that solved the above difficulties. A roller coat method of applying the enamel to the metal film was also devised and is in use at the present time.

After firing, the resistors are fitted with wire leads which are soldered thereto. The units are then assorted to values, such as 1, 10, 100, 1,000, 10,000, 50,000 and 100,000 ohms. From these basic resistance values, any conceivable value from 1 ohm to 100 megohms, within tolerances of plus or minus 1 percent may then be obtained by the spiralling process. The spiralled resistor is then complete and ready for use in circuits of most exacting requirements. Units of various resistance values were set aside for resistance stability study. After 60,000 hours (which is equivalent to 7 years) elapsed time, the X-type "Nobleloy" metal film resistors were all within 0.1 percent of their initial value.

The conventional carbon-type resistor is designed to dissipate approximately 1 watt per square inch. The "Nobleloy" type resistor, however, with its unique metal film construction, will safely dissipate 4 watts per sq in. This design factor of 4 watts per sq in. is utilized in the industrial high-wattage type resistors

where resistance tolerances are standardized between plus or minus 5 and 10 percent. For precision application, however, a design factor of 2 watts per sq in. is used. This procedure is followed in order to keep the effects of temperature coefficient at a relatively low value. The average temperature coefficient of resistance pertaining to the "Nobleloy" X-type metal film resistors varies between the limits of -0.0002 to -0.0005 which, in other words, is equivalent to approximately -0.035 percent per deg. C. Recently, new alloy-type metal films have been developed for the fabrication of ultraprecision-type resistors. Test data indicates these units to have a temperature coefficient approximating that of the well-known alloy, manganin.

Let us now turn our attention again to the printed circuit and see how the metal film resistor and interconnecting circuits could be incorporated therein.

The first procedure would be to provide two masks. The first of these would provide for the necessary wiring and interconnected inductors. The second mask would provide for the necessary resistors. The required capacitors would be affixed in their respective places after printing.

The first mask, carrying the wiring and inductors, would be fixed into place on a ceramic plate. A special metallo-organosol alloy solution would then be sprayed into the openings of the mask and permitted to air-dry. The second mask would then be affixed in place and an organosol capable of yielding high resistance metal films would be sprayed into the openings. The same process would be repeated on the reverse side of the ceramic plate to provide for the necessary network.

The entire ceramic plate thus processed would be fired in order to metallize the circuit. The same mask employed in spraying on the resistor components could be similarly used in spraying on a film of vitreous enamel over the resistor surface and then refired. The whole process, in the author's estimation, should not take more than 30 minutes to complete.

Since a thorough investigation of the possibilities of using the metallo-organosol process pertaining to the printed circuit has not been made, it is recognized that changes in the procedure described will have to be made. In the first place, the resistivity of metals akin to palladium is within the range of 9 to 11×10^{-6} ohms centimeter, whereas that for elemental carbon is approximately $3,500 \times 10^{-6}$ ohms centimeter at 0° C. In the second place, in the fabrication of metal film resistors using the ceramic rod or tube, one may resort to the process of spiralling in order to adjust the unit accurately to the resistance value required.

This, however, cannot be done in the case of the printed circuit. Therefore, other procedures should be devised in order to attain the same end.

The metallic film could be deposited in the form of a noninductive grid, which would increase the film length and, consequently, its resistance value. In order to adjust the metal film resistor thus formed, care should be exercised in that the initial value of resistance thus

received should necessarily be a certain percentage above the resistance value required and then trimmed down to within its tolerance range. This could easily be accomplished by superimposing, or tracking, a metal of low resistivity upon the deposited grid, thus permitting the initial resistance value to recede as required. The capacitors and tubes would then be affixed into their respective places, thus completing the process.

6. Trends in Military Communication and the Applicability of Printed Circuits "

This paper is presented in two parts with two objectives in mind: First and principally, to acquaint the reader with military communication equipment trends, especially as they affect component development; and second, to consider the applicability of printed circuits in furthering certain of these trends.

The most important of these communication trends, insofar as components, materials, or techniques are concerned, is reduction in equipment size, even in the face of increased complexity. The earliest military "walkie-talkie" was a simple super-regenerative transceiver employing only two tubes which occupied 650 cu. in. The replacement for this set was an FM transceiver employing 18 tubes, which occupied 575 cu. in. The latest version of the "walkie-talkie", currently under development, will employ 16 tubes and occupy approximately 125 cu. in. Advances in miniaturizing equipment have thus made important strides in incorporating eight times as many tubes and their associated circuits in one-fifth the space. Tactical applications of such equipment, however, requires even further reductions in size and weight. This can only be accomplished if reduction in the physical size of components continues, new techniques are developed, or major circuit simplifications are accomplished.

The term "miniaturization" has generally been associated only with extremely small equipment. In military communications, however, miniaturization is not limited to subminiature construction. It also includes the reduction in size of 60-line switchboards and even 5-kw transmitters to permit their use as mobile equipment.

One component problem inherent in miniaturization, whether it is a subminiature unit or a 5-kw transmitter, is that of heat dissipation. In reducing the size of equipment, whether this

reduction is accomplished by a reduction in size of the components or in the evolution of a new technique, it will be a major achievement if the efficiency can be maintained. These smaller components or units will therefore have to dissipate as much heat as their larger prototypes. This may very well be the limiting factor in the degree of miniaturization that can be obtained. Miniaturization, especially subminiature construction, also means the crowding of components into less and less space. This again can only result in higher ambient temperatures.

A second development trend is that toward unitized construction. The earliest examples of such construction stressed unitization of design almost entirely from the maintenance standpoint. Subsequent steps in this trend were directed toward reduction in size and improvement in performance. This type of construction has finally evolved into plug-in hermetically sealed stages or subassemblies employing soldered-in subminiature tubes.

From the component viewpoint, this hermetically-sealed type of construction offers one big advantage in that it seals off components from the high humidity effects present in most areas. It also, however, imposes strict requirements on the stability of the components used in these assemblies due to changes in temperature, age, and particularly shock or vibration, especially those components used as frequency determining elements. This is quite evident when one stops to realize that in a hermetically sealed IF stage, for instance, adjustments are not possible once the unit is sealed unless the seal is broken or some relatively large and complicated mechanism is used.

During the past war, due to the pressure of getting equipment into the field, equipment was primarily designed for particular applications. The trend at the present time is to develop universal equipment having sufficient flexibility to permit adaptation to a number of applications.

¹¹ By B. V. Blom, Signal Corps engineering laboratories, Fort Monmouth, N. J.

While this general heading of increased flexibility covers a broad field, two items of particular interest are increased frequency coverage and increased number of preset channels.

Increased frequency coverage requires tuned circuits with increased tuning ranges. Tuning ranges of 1 to 6 mc, 5 to 30 mc, 20 to 70 mc, and 50 to 500 mc, are typical examples. Components and techniques are needed which will permit accomplishment of these tuning ranges in an acceptable size.

Equipment developed during the past war, while covering a fairly large frequency band, provided only from 1 to 10 preset channels. This relatively small number of presets permitted the use of a crystal for each preset. The trend at the present time is to make all channels immediately available to the operator. This will be equivalent to providing from 80 to 1,000 or more preset channels and will require the use of crystal saver or reference crystal type circuits or of self-controlled oscillators having essentially crystal stability. From the viewpoint of increased flexibility, the self-controlled oscillator seems to have most to offer. The development of an oscillator with stabilities of crystal order, however, imposes extremely severe requirements on the stability of the components used in these oscillator circuits. For example, in one particular case, an oscillator, which is being designed to cover the 20 to 70 mc band, has a capacity of 25 $\mu\mu\text{f}$ and an inductance 0.4 μh at 50 mc. In order to achieve the required stability, this inductance and capacity must be maintained, under all operating conditions, within two parts per million per degree centigrade.

Reliability has always been one of the primary requirements for military communication equipment. Its importance has been stressed time and time again, and much has been achieved in the development of reliable components for military usage. Certain trends have developed of late which, however, put even more stringent requirements on reliability of operation. In the past, equipment failure has meant, at most, the loss of one communication channel. With the advent of multichannel radio relay equipment, failure of some components of a radio relay system can result in the loss of 24 channels of communication. This figure may rise to as large as 100 channels in the near future. The increased use of components which are common to a number or all channels of multichannel equipment can result in material savings in size and weight. For instance, one such scheme under consideration is the use of electronic multiplexing in telephone carrier equipment, using one oscillator common to all channels. Obviously, since in this application failure of the common oscillator will put all

channels out of operation, the advantages of obtaining miniaturization by using common circuits have to be balanced against reliability of operation and it can only be employed to its fullest extent when the reliability of components so warrant.

Multichannel radio-relay systems are also tending toward unattended operation of equipment installed at remote locations. Such operation imposes the very ultimate in reliability on components. This type of operation also raises another interesting problem. Whenever life-figures have been quoted in the past, they have been average life-figures based on a relatively large number of failures. If a life-figure of 10,000 hours was quoted, it meant that the average unit or some 70 or 80 percent of the units would operate 10,000 hours before failure. In unattended operation, this average life-figure does not have much meaning. The information that is actually required is the guaranteed life of say 99.99 percent of the components. Whether this guaranteed life is 2 months or 12 months is relatively unimportant as compared to a definite knowledge of the guaranteed life. If this guaranteed life were only 1 month, it would simply mean that this unattended station would have to be visited and this component replaced every month.

All previous equipment development trends have imposed increasingly complex requirements on components. There is one trend, however, that actually makes the problem easier. That is the trend toward lower operating voltages. Vacuum tubes are available today, or will be available shortly, which in most applications will give practically the same measure of performance as older type tubes but which operate with only 1/3 to 1/10 the plate and screen voltages as their prototypes. One series of these low voltage tubes is designed to operate with 24 volts on the filament, screen, and plate.

Radio communication equipment has been moving higher and higher into the radio frequency spectrum. Prior to World War II, 65 mc was the highest frequency used for communication purposes. Today, we have equipment operating at 5,000 mc, employing 65 mc intermediate frequencies. No one knows what the upper frequency limit may be, in the future.

Military communication equipment must be capable of working over increasingly wide temperature ranges. Initially, consideration was only given to the temperature ranges encountered in the temperate zone. Warfare in the African desert and the South Pacific jungles resulted in increasing the operating ambient temperature requirements to 145° F. The strategic value of the north polar regions in an aircraft or guided missile war are now introducing cold temperature requirements as low

as -80° F for storage and -70° F for operation. This combination of events has thus resulted in an equipment operating range of -70° to $+145^{\circ}$ F. Within this temperature range, rapid temperature changes of up to 60° F can be expected. In addition to these general temperature requirements, the advent of high speed aircraft with high skin temperatures are introducing requirements for components which will operate at 200° C.

Still another trend is that toward the increased utilization and importance of communications in modern warfare. The importance of radio as a means of communication increased from the position of almost a curiosity in World War I to that of a major communication source in World War II. Even with the tremendous increase in communication facilities made available by this increased use of radio in the past war, requirements for wire communication facilities also increased to the point where multi-channel carrier telephony equipment and teletype equipment were required to handle the wire traffic. This increased demand for communication facilities will make mass-production capabilities one of the major design considerations for all future military equipment.

In summarizing, the following equipment design trends are to be noted: (1) Miniaturization (reduction in size), (2) unitized construction (hermetically sealed plug-in assemblies), (3) increased frequency coverage, (4) increased number of preset channels, (5) increased reliability, (6) lower operating voltages, (7) operation at higher frequencies, (8) operation over extreme climatic conditions, and (9) increased mass-production capabilities.

The applicability of printed circuits in furthering these development trends seems to offer much in furthering the last of the design trends summarized—that of increased mass-production capabilities. During the past war the two primary shortages were in strategic materials (that is, materials which were not available or in short supply in this country such as rubber, tin, mica, quartz, etc.) and manpower. Strategic materials can be stock-piled or substitutes or synthetics can be devised. Manpower cannot be stock-piled and the only substitute is machine power. The fact that the production of printed circuits is a machine process is therefore of primary military importance. Being a machine process, the technique offers a number of advantages and also imposes some new problems. Mechanized production of radio equipment will result in more uniform production, reduction in inspection time and cost, and reduction in line rejects. Quality control problems and stocking problems will be considerably reduced since resistors need not be stocked in their multiplicity of values and wattages, but

will be mixed in the plant from the basic ingredients. This also applies to capacitors which will be purchased in sheets and then stamped out to the required capacity. A multiplicity of wire sizes and types will be replaced by a silver paste. One of the problems that will arise, however, will be the fabrication of accurate components. For example, 5 percent tolerance resistors are now obtained by a process of selection after fabrication, and accurate inductances are obtained by adjustment after winding. Neither of these processes is possible where the circuit is printed directly on a form. Industry has a long record, however, of overcoming such obstacles whenever the goal is worth the effort.

Most early publications on printed circuits placed primary emphasis on the reduction in size possible with this technique. While the application of printed circuits to military communication equipment may result in some reduction in size, in the opinion of the writer, the degree of miniaturization will not be startling. A three-stage audio amplifier was built at the Signal Corps engineering laboratories using conventional subminiature technique and comparing in size with a commercial three-stage printed audio amplifier of a certain manufacturer. From this comparison it was apparent that even with the most advantageous use of space, the printed circuit amplifier could not be made substantially smaller than that employing conventional miniaturization techniques¹²

In connection with the trend toward unitized construction, printed circuits offer many interesting possibilities. The inherent type of construction used in printed circuits is such as to lend itself very readily to its employment as plug-in subassemblies. While the hermetic sealing of these units may be a more difficult problem, the sealing of the unit by means of a protective coating such as Selectron might be an acceptable solution. With respect to the stability requirements imposed by the sealing of these units, the use of printed circuits seem to offer some decided advantages over conventional techniques, especially with regard to immunity to shock and vibration. The very nature of printed circuits also lends itself admirably to the application of the technique of plating coils on highly stable forms such as fused quartz, a technique which holds much promise with regard to temperature stability.

In general, to the best of the writer's knowledge, printed circuits (as differentiated from

¹² *Editors note:* The author points out the very real misconception that in all cases printed circuits will lead to greater miniaturization than is possible by other means. In many cases, using newly developed subminiature electronic components, a device may be made as small as a printed circuit unit by using standard miniaturization techniques. Examples do exist, however, as pointed out in the general discussion, where printed circuits allow miniaturization which cannot be duplicated by other methods.

plated or printed components) in their present stage of development, have been applied primarily to high frequency fixed-tuned or untuned circuits which do not have critical resistance, capacity or inductance requirements. This limitation on the number of applications to which printed circuits have been applied may be due in part to the relatively poor stability of high K ceramic capacitors, to the accuracy with which resistors can be printed and to the inability to adjust the resonant frequency of printed circuits. With these limitations, the application of this technique to "high-performance" Signal Corps communication equipment must necessarily be restricted almost exclusively to audio amplifier circuits. No doubt these problems are being studied and solutions may be at hand which will permit their more

widespread use. Circuit applications such as intermediate frequency amplifiers, multivibrators, etc., seem to be admirably suited for the application of printed circuits if and when these limitations are eliminated.¹³

To summarize, the printed circuit technique has been developed to where its practicability has been established, basic advantages have been proven, direct applications have been found, and many interesting possibilities have been envisioned. Most of the applications of printed circuits, insofar as a furthering of military communication equipment development trends is concerned, fall in the category of future possibilities. It is hoped that this paper will assist in speeding up the day that these interesting possibilities will become accomplished facts.

7. Vitreous Enamel Dielectric Products¹⁴

During the past war the critical shortage of mica resulted in the Signal Corps' sponsorship of research on alternate materials, particularly for use in electrical capacitors. As part of this program, a research contract was placed with the electrochemicals department of du Pont in their plant in which raw materials are produced for the ceramics industry. This contract, still in force, in modified form resulted in the development of materials and a process for making vitreous enamel dielectric capacitors with electrical characteristics comparable to silver mica capacitors.

The inherent high quality of this product plus the fact that the process is admirably adaptable to the production of units involving printed circuits resulted in a development program by du Pont and the Remington Arms Co., a du Pont affiliate, to evaluate the commercial possibilities. Consequently, we are currently producing samples of single unit capacitors similar to conventional products and "specialty" units involving printed circuits. The process and typical products will be described.

Process

The process is based in the laying down by spraying of layers of vitreous dielectric enamel alternating with layers of conductive silver paste deposited by silk screen or squeegee printing.

The requirements on the silver paste have been discussed by Mr. Patton in another paper. The enamel is of suitable consistency for spray-

ing and in general consists of 15 to 25 mole percent of silica, 3 to 11 mole percent of alkali oxides, 5 to 11 mole percent of alkali fluorides, 15 to 25 mole percent of lead oxide and 11 to 30 mole percent of other bivalent metal oxides.

The basic unit of the process is the build-up machine in which the desired structure is built up on 9-by-12-in. steel conveyor plates. The steel plates are loaded onto a conveyor which is arranged in a rectangle. The conveyor carries the plates into a paint spray booth where the enamel is applied from a spray gun, which sprays downward onto the horizontal surface of the plates.

The plates, after receipt of the sprayed enamel, are carried by the conveyor through an infrared drying tunnel in which the enamel dries to a consistency which we refer to as "cheesy." For the next step, the plates are momentarily halted at a station where the desired silver pattern is squeegeed on them. This pattern may contain as many electrodes as can be drawn within the area of the steel plate and the configuration of each of these electrodes may be anything that can be printed by the

¹³ *Editors note:* See other opinions on these points in general discussion. Printed circuits have been applied successfully to the design of two-way personal transceivers of the tunable type meeting F.C.C. frequency-stability requirements (see paper by Al Gross), to the design of intermediate frequency amplifiers, and to circuits such as multivibrators, etc. Limitations on high K ceramic capacitors are gradually being overcome by continued research; however, printed circuits are not limited to this type of capacitor as the following paper indicates. Other papers in this series describe accurate resistors for printed circuit applications.

¹⁴ By C. I. Bradford, technical department, Remington Arms Co., Inc., Bridgeport, Conn.; S. A. McNeight, electrochemicals department, E. I. du Pont de Nemours and Co., Inc., Perth Amboy, N. J.; and B. L. Weller, technical department, Remington Arms Co., Inc., Bridgeport, Conn.

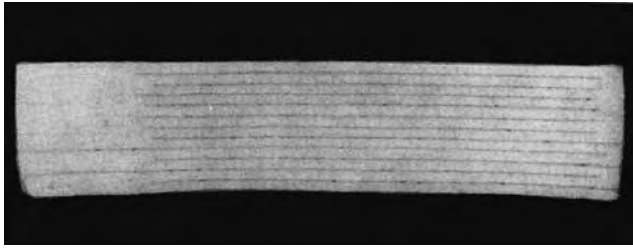

FIGURE 7.1. *Microphotograph of cross section of a vitreous dielectric capacitor.*

squeegee printing technique. After receiving the silver pattern the plates continue along the conveyor to the spray booth.

This spray-dry-silver cycle is repeated until the desired structure has been obtained. On leaving the machine, the plates pass through a mechanism which cuts the build-up into units of appropriate size and shape. Next, the plates are baked to remove some of the organic matter, to free the enamel-silver structure from the steel plate, and to impart to each cut unit sufficient rigidity to allow it to be handled.

Depending upon the relation between the silver patterns and the size of the cut unit, silver will be exposed at specified points on the edges. Any desired connections between different layers of exposed silver may be made by applying silver paste to these edges. The units are then fired for about 12 hours to produce a monolithic structure typical of vitrified ceramic articles. The electrodes at the top do not extend to the sides since they form another capacitor. The fired unit (fig. 7.1) at this stage of the process is a usable capacitor to which, in ordinary practice, leads are attached and a finish is applied.

Product Description

This process can be used to produce a wide variety of capacitors with dimensions limited only by economic considerations. The present equipment is capable of making pieces with maximum dimensions of 6 by 8 in. It is possible to cut the single units as small as 0.3 in., and the most economic thickness is of the order of $\frac{1}{8}$ in.

The simplest form which these units can take are those incorporating single capacitors. The particular sizes and dimensions are governed by product design considerations. The electrodes are terminated along the edges of the capacitor and connections are made to the end silver. The product has sufficient mechanical strength to make it unnecessary to enclose it in rigid plastic, and an organic finish is adequate to give electrical insulation. These units can be supplied in capacitances up to 5,000 $\mu\mu\text{f}$; however, the relative economics favor the capacitances of less than 1,000 $\mu\mu\text{f}$.

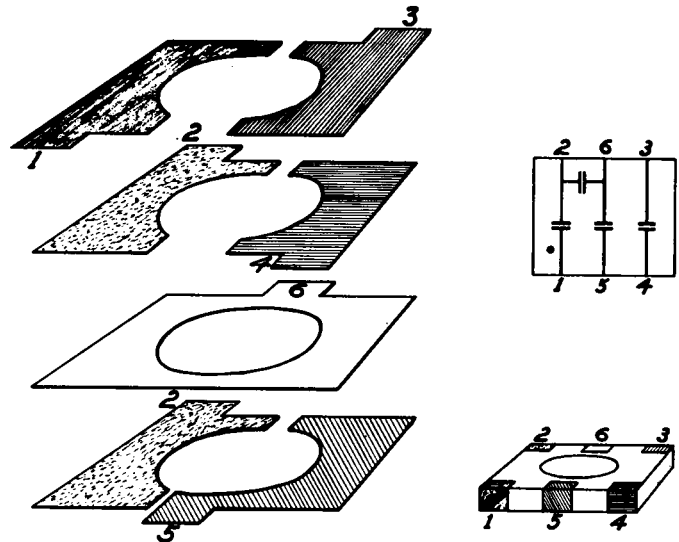

FIGURE 7.2. *Arrangement of internal electrodes of four capacitor, S-3 unit.*

The production technique can easily be extended to include numerous capacitors incorporated in one unit. This one unit contains two capacitors which have a common terminal at one edge and separate terminals at the other. This particular arrangement contains an electrostatic shield between the separate plates which is connected to the common terminal. A similar application to two capacitors in one unit may be used as the tuning capacitors for i-f transformers. In this case a hole through the chip is provided for mounting the i-f coils or making the core accessible for tuning.

Although there is no limitation to the combinations of capacitors which can be built into a single unit (fig. 7.2), practical considerations usually make it undesirable to extend the combinations beyond about four to six capacitors. Capacitors between electrodes 5 and 6, 2 and 6, 1 and 2, and 3 and 4 are formed with multiple dielectric thicknesses although only single layers are illustrated here. Connections to these units are made with the tabs that are shown. Proper design reduces unwanted capacitances below the limits allowed from circuit considerations. In a completed unit of this type, the six terminals have been made with end-silver. A hole through the center of the unit is supplied as in the two-capacitor unit. External silver may be arranged to receive resistors on the surface of the ceramic. The International Resistance Corp. is cooperating with us in this program and has developed resistors with characteristics comparable with the best conventional commercial units. A four-capacitor, one-resistor unit for incorporation in the base of a final i-f transformer has been designed in cooperation with the F. W. Sickles Co. It con-

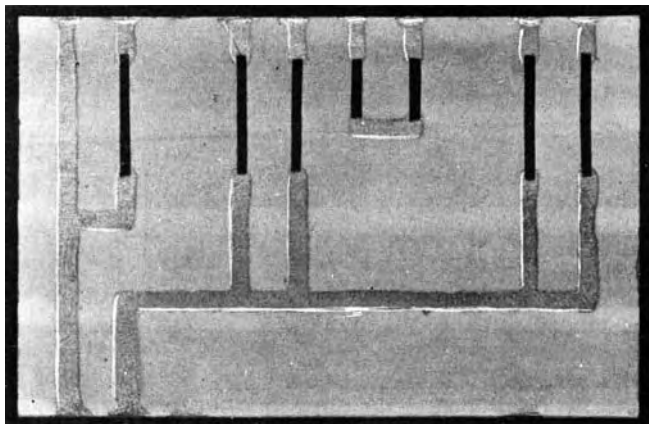

FIGURE 7.3. Two stage amplifier unit incorporating four capacitors as a part of the base plate.

tains the two tuning capacitors and a two-capacitor single resistor diode filter.

A somewhat different arrangement for use as a diode filter incorporates two capacitors and four resistors in one unit. This is an experimental assembly used to investigate the practicability of supplying eyelet terminals in the ceramic for special applications.

These techniques can be extended to accommodate an infinite number of combinations of capacitors, resistors, and inductors in complete circuits.¹⁵ Since conductors may be printed either internally or externally, the arrangements need not be limited to one plane (fig. 7.3). This block contains all circuit elements and interconnections of a two-stage amplifier.

A cable connector unit illustrates the versatility of the process. The cable connector unit, about 1½ in. in diameter, contains four capacitors—one from each of the outer four terminals to the common central terminal. A high-voltage unit, about 1/10 in. thick, contains floating electrodes spaced 1/100 in. apart and will withstand operation at 20 kilovolts.

Electrical Characteristics

Of primary importance to the engineer who is interested in taking advantage of this process are the electrical characteristics of the materials used. The ceramic dielectric has a loss factor of the same order as mica and the properties of the silver are such that high electrical conductivity is obtained. Incorporation of this silver and the ceramic into a monolithic block adds the further characteristic of high stability.

To demonstrate how these properties are used to good advantage, the following characteristics of typical capacitors are given:

¹⁵ Editors note: See "Printed Vitreous Enamel Components" by C. I. Bradford, B. L. Weller, and S. A. McNeight, *Electronics*, December 1947, p. 106 for added details.

Capacity Range

At present, capacitors are made in 500-volt ratings only and result in units with approximately 0.02 μf in.² Typical sizes are 0.2 in. by 0.25 in. by 0.1 in. for 50 $\mu\mu\text{f}$ and 0.375 in. by 0.425 in. by 0.11 in. for 330 $\mu\mu\text{f}$. The smallest sizes obtainable are restricted only by lead capacitances and handling limitations.

Capacity Tolerance

Since it is possible to adjust both the electrode areas and the dielectric thickness while producing these capacitors, good control of capacitance yield is possible. With appropriate sorting, capacitance to any tolerance can be obtained.

Capacity vs. Frequency

There is relatively small change in capacitance with frequency up through 20 megacycles (fig. 7.4). At about 50 megacycles inductive effects increase the apparent capacitance by about 10 percent. (Series inductance is of the order of 0.005 to 0.01 mH.)

Loss vs. Frequency

The fact that the dissipation factor is of the order of 2×10^{-3} at frequencies as high as 100 megacycles (fig. 7.4) is of particular interest to those who are working with FM or television. These data were taken for us by Mr. R. F. Field of the General Radio Co.

Capacity Drift

The capacity drift as defined in JAN-C-5 is 0.02 percent. This value places the drift within the rigorous limitations of the F characteristic and demonstrates the high stability of the unit.

Temperature Coefficient

A typical graph (fig. 7.5) of capacity variation with temperature shows the units to have a positive temperature coefficient of about 105 ppm per deg C. The capacitors are usable up to 125° C with little change in temperature coefficient.

Loss vs. Temperature

The inorganic nature of these units makes them basically immune to temperature (fig. 7.5). From practical considerations the maximum temperature is considered to be 125° C.

Insulation Resistance

The leakage resistance of these units is high and of the order of 10^4 to 10^6 megohms for

Circulars of the National Bureau of Standards

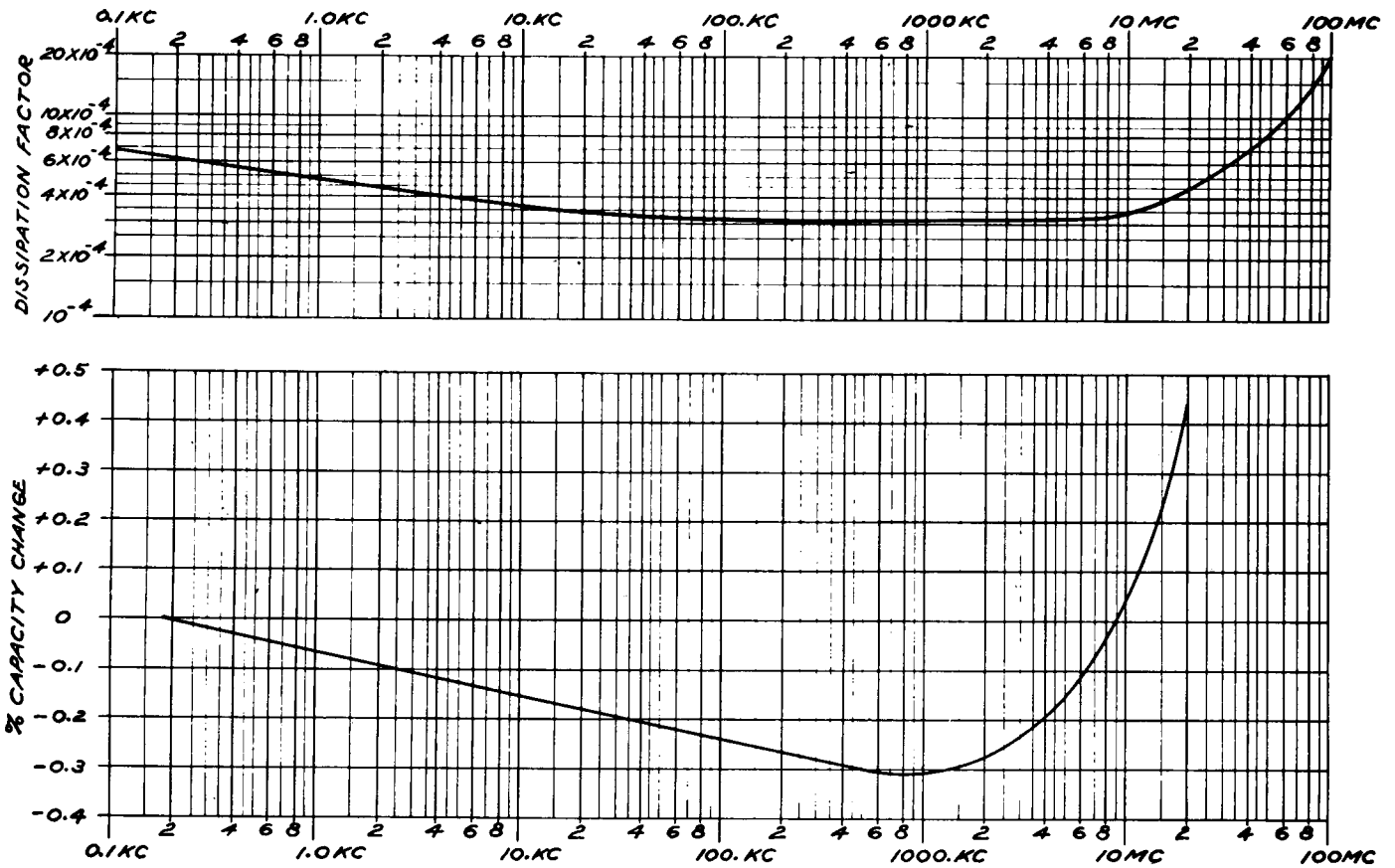

FIGURE 7.4. Graphs showing capacity vs. frequency and Q or power factor vs. frequency of vitreous dielectric capacitors.

capacitances up to a few thousand micro-microfarads. Proper finishing insures that this high resistance is maintained in spite of high humidity. Considerable data on the performance characteristics of this product are available at the Components and Materials Branch, Signal Corps Engineering Laboratory, Fort Monmouth, N. J.

Mechanical Features

The mechanical characteristics of units made by this technique have been touched on briefly in this paper. They can be summarized as follows:

The integral construction of silver and ceramic results in high mechanical strength approximately comparable to steatite. Although the material is brittle, it is adequately shock resistant to withstand normal handling. Leads attached directly to the block without further support can meet the pull and bend tests in common use.

A unique feature of the construction is the high thermal conductivity of the blocks. Since the most economical designs contain a minimum of unused ceramic, the silver is distributed

throughout the entire volume and the resulting thermal conductivity is excellent. This feature makes the unit relatively immune from heat-shock, and soldering of the leads directly to the end silver can be accomplished.

The units can be finished in any appropriate manner to meet particular applications. In general, it has been found that organic lacquers or waxes are sufficient.

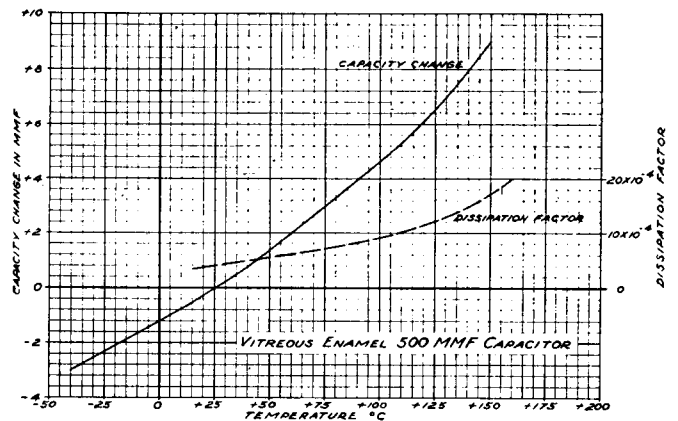

FIGURE 7.5. Graphs showing capacity vs. temperature and loss vs. temperature of vitreous dielectric capacitors.

Conclusion

In conclusion, the vitreous enamel process appears to offer attractive possibilities for the production of printed circuit subassemblies and the production of individual components because (1) the capacitor elements possess high quality electrical characteristics to an outstanding degree; (2) the mechanical properties of the basic capacitor units are superior to most of the components in general use in the communication-electronics fields; and (3) the process possesses an inherent flexibility which makes practical the combining into single compact units of several high quality capacitors with other circuit elements including their interconnecting leads by the printed circuit technique.

Acknowledgments

The authors of this paper acknowledge the contributions made to this development by Dr. C. Robertson, Dr. K. H. Ballard, and Dr. A. J. Deyrup of the technical division of the du Pont electrochemicals department and E. H. Schmidt of the du Pont engineering department. The contributions and cooperation of the members of the Signal Corps engineering laboratories is also acknowledged. The advice and assistance of Harold A. Wheeler, our consultant, and the contribution of T. G. Owen of Remington in the production of samples are also appreciated.

8. Printed Electronic Components on Glass¹⁶

It is desired to limit the discussion of this subject to those components for electronic circuits which have been reduced to commercial practice by Corning Glass Works, rather than to extend it to developments which are yet to be thoroughly demonstrated. Separate circuit components, such as inductances and capacitors of several types, are now commercially available while various combinations of such units are yet in their development stages.

Glass, the base material of these components, is generally characterized by good mechanical and electrical properties. It is hard, nonabsorbent, and cannot be permanently deformed. It is much lower in thermal expansion than metals, except those of the Invar type, so that dimensional changes with temperature are small. Glasses are regularly produced for which power-factor values are comparable with the best solid insulating materials available. Values of dielectric constant lie generally within the range of 4 to 9, which is satisfactory for most types of electronic applications, although it does not approach values obtainable in the titania ceramics. Except for surface resistivity, glass is unaffected by moisture, and nonhygroscopic coatings are available which reduce greatly this effect of moisture. Glass also has excellent nontracking properties, so that the surface is unaffected by surface leakage or adjacent discharges. Because of these properties,

glass is an ideal insulating material for electronic use. Glass is readily available in standard forms such as plates, tubes, and cylinders, and, when design considerations necessitate it, other special forms may be considered.

During the recent war period, extensive development work was carried out on the formation of metallized films and coatings on glass. This included the development of new techniques and the improvement of existing techniques. Films of one general type are formed by a vacuum metallizing process. They are of relatively high resistance and are of a permanent nature. The metal is deposited in a thin uniform film so that its resistance is relatively independent of frequency to high frequencies of the order of 100 Mc, and with low reflection of power loss at microwave frequencies. Values of d.c. resistivity for these particular films are readily obtainable within the range of 10 to 1,000 ohms per square, with a low positive coefficient of resistivity with temperature. The dissipating capacity of these films depends to a considerable extent on the size and shape of the glass part to which it is applied. Values of 7 watts per sq. in. with a temperature rise of 170° C have been attained on small glass strips mounted in still air.

Metal coatings of low resistivity can be formed by firing metals such as silver into the glass surface which bonds them firmly to the glass. In many cases this silver coating is covered with a second coating of electroplated cop-

¹⁶ By H. S. Craumer, Corning Glass Works, Corning, N. Y.

per, and then tinned to facilitate soldering. Such coatings can be produced to accurate dimensions and in a variety of patterns, to form circuits, conducting areas, etc., to which structural parts or terminal leads may be soldered without resorting to complicated techniques. The joint made by soldering to these coatings can be made vacuum tight so that it may be used for purposes of hermetically sealing.

The bond strength between the coating and the glass is roughly 2,000 lb. per sq in. and its resistivity when copper plated is approximately 1.8×10^{-3} ohms per square.

The current trend toward high frequencies for home receivers such as the 88–108 Mc band for FM, and frequencies of over 200 Mc for television, has created a need for capacitors and inductances of somewhat different characteristics than for those used in equipment operating at frequencies of about 1 Mc. A trimmer capacitor (fig. 8.1A) now being produced by Corning Glass Works illustrates this. Its size can be better appreciated by realizing that the thread of the adjusting screw is 4–40. In this capacitor the glass performs several functions: (1) Insulation between the two conductors; (2) mechanical support for the bushing on the panel at one end, and the terminal on the other; (3) a base material for the metallized surface acting as one plate of the capacitor; and (4) the dielectric material between the two conductors. In this case the conducting surface on the glass consists of a “fired-on” silver coating, copper plated and tinned. The assembly of the various elements of the unit is made by soldering.

The use of an Invar rotor, together with the glass, which is stable both electrically and mechanically, results in a trimmer capacitor with a low coefficient of drift with temperature. Its coaxial construction and design give it excellent frequency characteristics. The largest trimmer of the present line has a range of 1 to 12 $\mu\mu\text{f}$.

These capacitors are available in two types of mounting, one with a metal bushing and nut, and the other with a snap-on, or push-on mounting which reduces assembly time in set manufacture. The smallest capacitor in the line has a range of 0.3 to 3 $\mu\mu\text{f}$. The difference in the maximum capacitance ratings is obtained by adjusting the length of the metallized surface on the glass tube. A third intermediate size has a rating range from 1 to 8 $\mu\mu\text{f}$.

Inductors are also made utilizing the principle of metallized surfaces in the form of a spiral metallized ribbon applied to the outer surface of a glass tube, so that the conducting surface approaches the conditions of a theoretical current sheet. The advantages of this

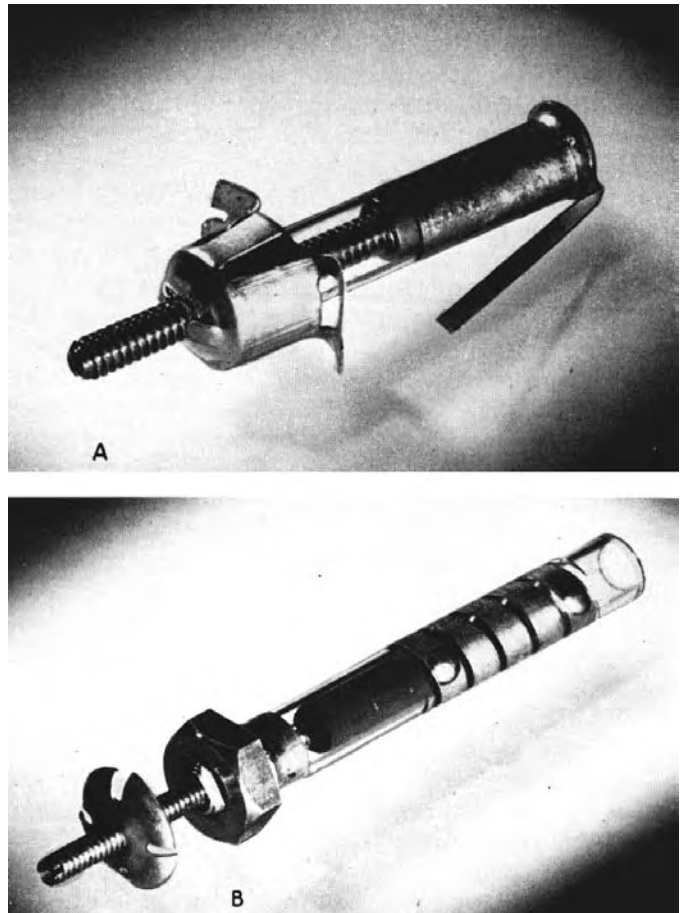

FIGURE 8.1.

A, 1 to 12 uuf midget trimmer capacitor with push-on mount. B, “Fixed-tuned” or “trimmer” inductance with powered iron core of standard 0.20 in. diameter.

type of construction are readily discernable. The metal being firmly bonded to the glass, remains in intimate contact with it, and dimensional changes with temperature are determined by the properties of the glass, which has a much lower coefficient of expansion than metals used as conductors. Dimensional tolerances from piece to piece, both as to diameter and coil pitch, can be controlled within close limits in manufacture. Inductors of this type may be used for permeability tuning in the 88–108 Mc. FM band. Three inductors are normally used in such a receiver, one in the antenna circuit, and one each in the RF and the oscillator stages. These inductors can be mounted conveniently by the use of a conventional grommet on one end. The metallized surface is dipped in water-protective lacquer to make it weather resistant. This dip does not interfere with ease of soldering to the metallized surface. Connections and taps may be soldered to any point on the spiral ribbon. Quality control checks on this inductor in production measure an average Q-value of 180 at 100 Mc. The temperature coefficient of the

inductance at 100 Mc is of the order of 7 parts per million per degree centigrade, and is always positive.

Another inductor used for second subharmonic operation of the FM band has a pitch of $8\frac{1}{2}$ turns per inch, as contrasted to the 4 t.p.i. for the first inductor shown. Fifteen turns per inch is normally considered a maximum, because a finer pitch complicates the termination problem, and tends to lower the Q-value, because of the increased d-c resistance of the turns.

Both inductors are designed for use with powdered iron cores with a standard diameter of 0.20 in. The glass form of the first inductor shown has a wall thickness of 0.035 in., while for the second it is 0.070 in. These wall thicknesses, which have been standardized, permit ample frequency spread and facilitate tracking of the various stages of the circuit.

A "fixed tuned" inductor (fig. 8.1B), or it might perhaps be termed a "trimmer," has an application in those cases where the 88-108 Mc FM band is variable capacitor tuned to facilitate tracking. It can also be used for fixed frequency circuits. This particular inductor has a rating of 0.07 to 0.1 μ h and uses the standard glass form and powdered iron core mentioned previously. This unit is mounted

and locked in the panel in a manner similar to that already described for the midget trimmer capacitors in the first part of the discussion. A 4-40 screw attached to the powdered iron core permits fine adjustment of the inductance. These inductors are also supplied with the push-on mounting. Since powdered iron cores are also available with a diameter of $\frac{3}{8}$ in., inductors can be made suitable for this size of core also.

The glass used for the forms of these inductors is a low expansion glass of good electrical properties. It is considerably lower in dielectric constant than that of the glass used for the trimmer capacitors.

Although the components discussed here are of relatively recent development, experience has indicated that the principle of metallized glass applied to them represents an eminently satisfactory solution to many of the problems involved in designing radio equipment for the higher frequencies. It is obvious that these principles can be expanded to still other single components and in combining one or more components into a single unit. Specific discussion of such developments may best be left for some future occasion, when it is hoped that a more concrete and complete contribution to this phase of the subject can be presented.

9. Electrical Circuits on Plastics and Other Nonconductors¹⁷

Metals may be applied to plastics by cementing, by stamping, by inlaying, etc., and these methods are both simple and relatively cheap. Metal coatings may also be applied to plastics and other nonconductors by a variety of other methods, but these are usually more expensive so that they are used for special requirements such as electrical circuits, thin metal coatings, and decorative effects. In the second group of methods the metal at some stage of the process is in a finely divided form, e.g., powder, atoms, ions, etc. For simplicity, these methods will be termed metal plating and include metal evaporation, metal spraying, metal dusting and painting, and chemical reactions, with or without electroplating.

Metal plating is used to apply circuits to non-

conductors for applications in which intricate shapes of conductor and insulator are necessary or in which thin layers of metal are required. Examples are shielded housings, Faraday shields, condensers, direction finding loops, airplane antenna masts, high frequency wave guides, slip rings, special commutators, piezoelectric crystals, coils, connector circuits in electrical devices, etc.

Methods of Metal Plating

A wide variety of methods has been reported for the coating of nonconductors with metals. Some of them have proven unsatisfactory or of limited application because of high cost, poor adherence, porosity, or poor mechanical properties. All the methods involve a number of steps and some require special and expensive equipment. Extreme cleanliness and care are

¹⁷Contribution from Metaplast Co. Inc., New York, N. Y., by Charles E. Marlies, associate professor of chemical engineering, The City College, New York, N. Y.

an indispensable requirement of success in these methods.

The methods of plating metals on nonconductors may be classified into metal spraying, vacuum deposition, metal dusting and painting, and chemical reaction. After applying the metal coating by one of these methods, the coating may be electroplated to enhance conductivity, increase strength, extend wear resistance, increase corrosion resistance, or even improve appearance.

Metal Spraying

The metal in the form of wire or powder is fed into a special oxy-gas gun and blown on the surface being coated. A low fusing metal must be used on thermoplastics so that the plastic will not be burned or softened. If other metals are desired, they can be sprayed or plated over the initial coat. Metal spraying finds its best use in the production of relatively thick layers of metal.

Vacuum Deposition

There are two of these methods: metal evaporation and cathode sputtering. They are usually relatively expensive and find their best use for special cases, e.g., the exact duplication of the underlying surface as for sound recording, light reflection (especially first surface mirrors), etc., or for the production of a film of a metal which cannot be applied by chemical reaction, especially a film of aluminum. Both methods involve the use of vacuum chambers to house the article and carry out the operation. Highly plasticized materials require longer times and higher pumping speeds owing to the volatilization of the plasticizer.

The surface of the material must be cleaned very carefully for good and uniform adhesion. In metal evaporation the metal is contained in a small crucible or is in the form of a filament and is heated causing the evaporation of metal atoms which condense on the article and all other cool surfaces in the chamber. A vacuum of 0.001 mm Hg or better is required. In cathode sputtering the material to be coated is placed on or near a metal surface which is made the anode and the metal to be deposited is made the cathode. Under the influence of a high voltage, 2,000 volts or more, metal atoms in the form of ions leave the cathode and deposit on the article. A vacuum of 1 to 0.01 mm Hg is best.

Vacuum deposition methods are usually slow and tedious compared to other methods, because the chamber must be charged and evacuated, the metal deposited, and finally the vacuum must be broken and the chamber emptied.

Dusting and Painting

The application of a binder and a conducting material is a very old procedure. Originally wax was used as binder and graphite as conducting material. This combination is still extensively used for electrotyping and the production of molds to be stripped, but cannot be used if any degree of adherence of an electroplated metal coating to the nonconductor is required. This method involves using a wax object or coating the object with warm liquid wax, allowing to cool and dusting with graphite or spraying with a graphite suspension. Graphite is employed because it is attracted by the wax in preference to water. An alternative method is to use a mixture of graphite and a suitable binder. A disadvantage of graphite is relatively low conductivity. One method of increasing the conductivity of graphite coats is to dust with iron powder and then immerse in a copper sulfate solution; the iron displaces the copper from solution and the copper plates out on and covers the graphite. The low conductivity of graphite makes it useful for the production of resistors in printed circuits.

Greater conductivity is obtained by using a metal powder. This may be applied by coating the object with a tacky material and dusting or brushing with a metal powder. However, a more convenient method is to use a bronzing mixture, consisting of lacquer or varnish containing a relatively large amount of metal powder. This is a one-step method requiring simple equipment. The conductive paint may be applied by brushing, dipping, spraying or printing.

Regular lacquer spray equipment is entirely satisfactory for spraying the paint. A suction feed with the container attached to the gun is best because the constant motion during spraying keeps the paint well stirred.

The size, shape, and surface character of the metal particles are extremely important in determining covering power of the paint and the conductivity of the final film. Small size and flat shape are most desirable. Note, however, that aluminum leaf pigment used in aluminum paints is unsuitable, because the surface of the metal particles is composed of aluminum oxide so thin as to be transparent but nonetheless a nonconductor.

Although relatively expensive compared to copper and other base metals, silver has a number of advantages over other metal powders. Thus, silver has the highest conductivity of all metals. Copper and other base metals form metal salts with the organic acids in the medium and cake in the container. The corrosion products of copper and other base metals which may form as the film dries are nonconductors,

whereas, all corrosion products of silver (silver sulfide, silver chloride, etc.), are conductors. Because of these advantages silver may be used with a higher ratio of binder to metal powder than can any other metal, and conductive silver paints are commercially available which are stable indefinitely, which is not the case with any other conductive metal paint.

Silver has a further advantage over base metals when used on ceramics and similar materials which can be fired. Base metals oxidize during firing, thus losing conductivity. A binder is used which fluxes with the ceramic on firing. The conductivity of a fired silver paint is considerably greater than that of an air-dried paint.

Chemical Reaction

The methods already described may be termed physical in that the metal exists as such before application to the nonconductor. A second class, which may be termed chemical, involves using a chemical compound which is reduced to metal by chemical reaction.

Metal may be deposited from unstable gaseous compounds under appropriate conditions, e.g., nickel from warm nickel carbonyl. However, this method has not been found feasible for coating nonconductors because of equipment needed, temperature requirements, poisonous nature of compounds, cost, etc.

High temperature reduction is widely used for applying the noble metals to ceramics and similar materials which can be fired. A compound of the metal is used in solution or suspension in a suitable medium, often organic or containing an organic binder. Reduction takes place by dissociation of the compound at high temperature, assisted by chemical reduction by the organic material if present. This method is not suitable for applying a layer of appreciable thickness or high conductivity, but is excellent for applying a thin mirror-like film. It is widely used for the decoration of glassware and ceramics with gold or one of the platinum metals, and for the production of resistors in printed circuits.

Many metals may be deposited from metallic compounds in solution at ordinary temperatures using a suitable reducing agent. Not only is this method applicable to the noble metals, but also to many base metals. A large number of formulas for such reduction have been patented or otherwise published.

The production of silver films by chemical reduction is the method most widely used today for coating nonconductors with metals. When properly applied on a clean, smooth surface a mirror-like coating of silver can be obtained. However, the major application for this film

is as a conductive coat for electroplating. In this process the plastic is sensitized with a solution whose main ingredient is stannous chloride and then silvered with a mixture composed of freshly mixed ammoniacal silver nitrate and a reducing solution. Small objects such as disks are handled in quantity by immersion in the silvering solution. Large objects are usually coated by spraying with a special gun in which the silvering solution and reducer are mixed. Many special variations in composition of solutions and in handling have been worked out for particular materials and particular uses.

A number of "trick" variations of the silver reduction method have been reported, e.g., immersing phenolic plastics in ammoniacal silver solution without use of a reducing solution, the formaldehyde in the plastic causing reduction of the silver. These variations have been found uncertain in application, usually producing coats of low conductivity.

Production of Designs

The most important industrial application of metal plating a design on a nonconductor is for use as an electrical circuit. Metal designs are also put on plastics for decorative purposes.

Four types of methods are used to produce a design: stencil, stop-off methods, regular printing processes, and complete coverage of the nonconductor with metal followed by removal of selected portions of the metal coating.

A stencil is satisfactory when metal spray, vacuum deposition, or metal paint spray are used, because there is little chance of the conductive coat running under the edge of the stencil.

Stop-off methods must be used when applying metal paint by dipping or brushing or when depositing the metal film from aqueous solution, in order to prevent spreading of the coat. Either masking tape or stripping lacquer is used.

The most convenient method of applying a design is to use metal paint with regular printing processes, of which the screen process has usually been found the most suitable. Screens for printing the coating must be of high quality. The screen itself should be of fine weave for uniformity of printed pattern and sharp edge of line. The blocking material must be resistant to attack by the solvents in the paint. Printed circuits in electrical devices are usually made in this manner.

This method involves more steps than any of the three mentioned previously. However, it is more versatile so that it finds many applications where the others fail. Removal of the selected portions of the metal coating may be by chemical or mechanical means. Mechanical

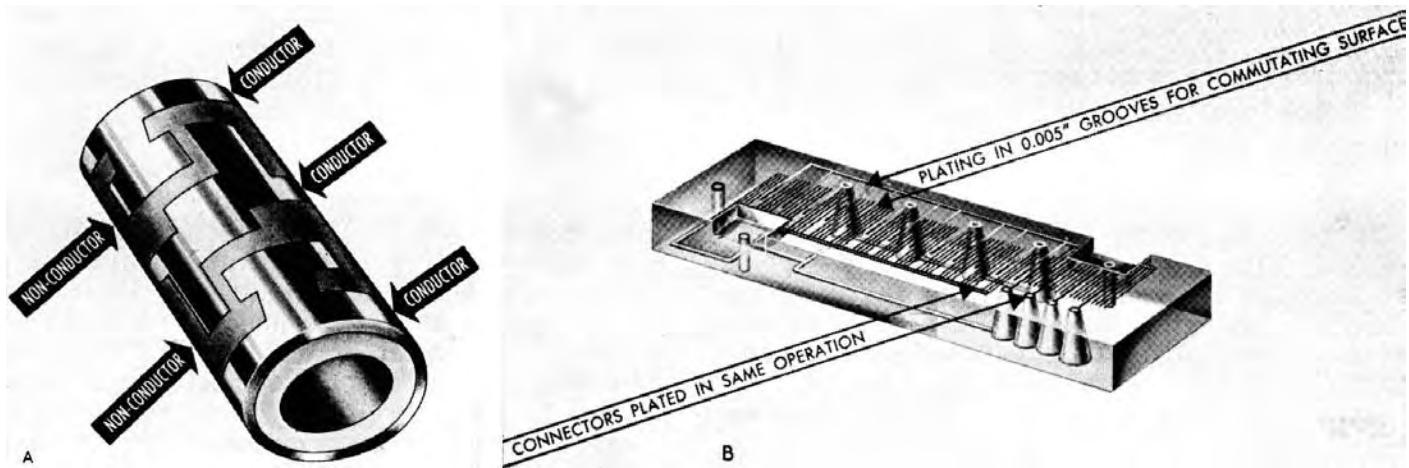

FIGURE 9.1.

A, Rotating commutator with intricate commutating surfaces plated into grooves. B, Flat commutator with three connecting circuits.

means is more common, especially if the metal coating is thick. Thus the commutators (fig. 9.1A) were made by machining or molding the circuits in the plastic, metal plating to a depth greater than the greatest depth of the molded design, and machining or grinding to a level surface. Another method is complete coverage of the surface, then removal of selected portions by abrasive blast through a stencil or other stop-off.

Electroplating

As stated earlier it is frequently necessary to electroplate the initial metal coating to improve electrical, mechanical or other properties. In such cases the initial conductive coating is usually applied with conducting silver paint or by the silver reduction method because of superior conductivity. Electroplating is more common on plastics than on ceramics, because firing cannot be used to increase conductivity as is the case with silver paint on ceramics.

Low conductivity is a great disadvantage because a nonuniform electroplated coating is produced, the plating starting at the cathode contact and gradually spreading. This effect may be partially overcome by making a number of fine wire contacts prior to electroplating. If the conductivity is too low the conductive layer sometimes strips before the plating has spread to the entire surface. The conductivity of silver paint coatings is considerably enhanced by burnishing with a dry lintless cloth, probably owing to removal of surface binder and to improved particle contact.

The suitability of a conductive coat for electroplating may be tested with an ohmmeter. Some of the above processes can be used several times to give second or third coats of conductive material, if a specimen is found not sufficiently conductive.

The electroplating process itself follows standard practice with minor variations. Thus,

since the conductive coat is usually very thin, a very high current density cannot be used initially on a large piece unless a number of contacts are made for distribution of the current. Hot baths cannot be used because they soften some plastics, distort others, and in any case introduce expansion problems which lessen adhesion. Furthermore, since the conductive coat is usually porous, highly acid or alkaline plating baths cannot be used on all plastics. The usual barrel plating methods may be used for small objects.

Electrical circuit designs are often electroplated to increase conductivity, and decorative designs are electroplated to improve the metallic finish. Naturally, all parts of the design must be in the electroplating circuit, which is best attained with a completely interconnected design. If the final design is to consist of several nonconnected circuits, sections of the electroplated design can be cut out later at appropriate places. Otherwise, separate electroplating contacts must be made to each circuit in the design.

Electrical Connections

Obviously, firm connections must exist in every portion of an electrical circuit. Perhaps the greatest drawback of the methods described in this paper lies in the difficulty of securing assured connections in all parts of the circuit, especially connections suitable for low voltages. The problem may be divided into two parts—connections within the circuit and connections to outside leads.

The major drawback to securing perfect internal connections is that the conducting material is finely divided at some stage of its existence, often in the presence of organic matter or other insulating material. As a consequence, there may be poor contacts between some of the particles, not only decreasing conductivity, but what is far worse, yielding conductivities which

vary from one article to the next or which in any one article decrease with time. This problem is minimized by using multiple layers of conductive coating. This problem can only be eliminated by electroplating the circuit.

Connections to outside leads are a major problem and must be given adequate consideration when designing the circuit. The problem is considerably simplified if the circuit is electroplated. However, even with electroplated circuits, soldering usually cannot be employed if the nonconductor is a plastic but may be used with ceramics. One satisfactory method of bringing in leads is to insert metal contacts beforehand at appropriate places in the nonconductor and applying the design on top. This method has been used in producing commutators. Another satisfactory method of bringing in leads is to have each circuit terminate in an enlarged area located over a hole in the nonconductor, so that a nut and screw can be inserted for holding the external lead and tightening the connection (fig. 9.1B). For piezoelectric crystals spring pressure on the faces is sufficient, the spring serving as part of the mount. Obviously, if the circuit is to be electroplated, the final leads should be made first, so that they will be electroplated firmly in place.

Adhesion of Metal Layers

For some applications of metal plated nonconductors, the metal layer is stripped, e.g., electroforming and electrotyping. The electrotyping industry in which copper is plated on wax and other nonconductors is the largest and oldest application of the deposition of metals on nonconductors. However, for most applications of metal plated nonconductors, the metal layer remains on the material, so that good adhesion is desirable. For some industrial uses, excellent adhesion under extreme temperature and humidity variation is essential.

In most metal-nonmetal combinations, there are one or more intermediate layers between metal and the nonmetal. The most common intermediate layer is a conductive coat such as graphite, bronze powder, chemically reduced silver, etc., which must be applied before electroplating. Other intermediate layers sometimes used are wax, varnish, etc. These intermediate layers complicate the situation considerably. Naturally, unless they adhere both to the metal and the nonmetal, the strength of the bond will be low.

Maximum adhesion between two surfaces such as metal and nonconductor is dependent on the formation of an interlayer which is stronger than at least one of the materials joined, i.e., on attempting to separate the ob-

ject as in tension or shear, the failure will be within one of the materials and not at the interlayer. Therefore, the following conditions must be met: (1) There must be no weak interlayers such as grease, dirt, etc., due to improper cleaning or preparation; (2) there must be no weak interlayers such as nonadhering powder due to improper application of conductive layer or improper plating; (3) all intermediate layers must be joined to neighboring layers by bonds stronger than the cohesive strength of the weaker material of the two to be joined. These bonds at the interlayer may be mechanical, due to the interlocking of rough surfaces, or may be valence forces, due to specific attraction between the two materials.

Due to the greatly different chemical natures of metals and nonmetals, there is little "natural" adhesion between the two. For this reason, roughening of the surface is widely used, both to increase surface area and to provide mechanical interlocks. But even in such case, it is difficult to obtain good adhesion if the metal is to have appreciable thickness (0.001 in. or more) because of the different coefficients of expansion of metals and nonconductors.

The coefficients of expansion of metals range from 0.5 to 3×10^{-5} per deg C., the highest values being those of cadmium, lead and zinc. The very useful metals, copper, nickel, and silver have values about 1.5×10^{-5} , and chromium has the value of 0.8×10^{-5} . The coefficients of expansion of plastic range from 2 to 20×10^{-5} per deg C., the lowest values being attained by only a few of the phenolformaldehyde types. Polystyrene, one of the most useful of the plastics for electrical purposes, has a coefficient of expansion about 7×10^{-5} . The coefficients of expansion of glasses and ceramics range from 0.1 to 0.8×10^{-5} .

If the metal film thickness is 0.001 in. or less, the metal expands and contracts with the basis material, whether ceramic or plastic, probably due to insufficient strength of the metal or presence of pores or fissures. For such thicknesses, adhesion of metal films is usually satisfactory.

If the metal film thickness is 0.001 in. or greater the metal expands and contracts with its own expansion coefficient, so that it frequently becomes detached from the basis material. In such case special precautions must be taken in the design of the object so as to provide mechanical interlocks by means of indentations, grooves, and reentrant curves. Usually, if the metal film thickness must be greater than 0.001 in., it is best to make it at least 0.003 in. Within the range 0.001 to 0.003 in., the metal film strength and stiffness are so low that blistering and splitting of the metal may take place during temperature change.

10. Imprinted Circuit Inlays¹⁸

The advantages in applying printed circuits to the design and manufacture of electronic equipment, such as radios, telephonic devices, hearing aids, transceivers, etc., have been clearly emphasized. Through the use of printed circuits in lieu of customary methods of assembly by means of a multiplicity of wires, soldered joints, etc., the manufacturer can now take advantage of a great saving in manhours and eliminate wiring errors in the basic grid lay-out.

The method of printing circuits described herein will be referred to as the "imprinted circuit inlay." In this method all of the circuit conductors are cut out of a solid sheet of silver as a single grid and firmly attached to a dielectric panel (fig. 10.1) by fusing it to and imprinting it into the dielectric material in a single operation. The process is fully mechanical.

Present experiments indicate that in the near future we shall be able to produce a printed circuit which will also include resistors. The main problem in this respect is the development of suitable resistive materials for the varied ranges of values that will cover the requirements of any standard circuit.

Through the use of properly designed steel embossing and cutting edge dies, every detail of the entire schematic is cut out of a sheet of solid silver ranging in thickness from 0.001 to 0.003 in. The possibility of wiring errors is thus nonexistent.

A separate steel die is employed for each side of the dielectric base plate. This solves the wire-crossover problem. With one portion of the basic grid imprinted on each side of the base plate, eyelets, rivets, or other suitable

means may be used to form the connections between them.

The dies are mounted on the heater plates of an embossing press. These plates slide in and out of the press, thus allowing a quicker change-over from one circuit design to another. In mounting the dies, care is taken to properly align the dies to give equalized pressure in relation to the center of the die-layout and of the heating plate. The heater plates with dies properly mounted are heated in the press by means of built-in electric heating units. Controlled heat is an important factor in giving the proper indentation within a given time limit. As mentioned, the design of the die allows cutting and imprinting in one operation. After the silver is cut to shape it is fused to the dielectric material of the base material through use of a suitable sizing which liquefies under heat.

Another important factor of our method is the pressure applied to the cutting and embossing dies; this is accomplished through use of joint-knuckle type stamping and embossing presses, which have a high-working pressure yet allow a smooth dwell pressure. The correct amount of pressure can easily be regulated by hand control and the opening of the press can be quickly set for various thicknesses of material within given limits. For testing and short runs a 15-ton hand-operated embossing press seems ideal. Power operated presses for long production runs are readily available. For short runs the silver is hand fed in sheet form; for long production runs the conductive material may be fed automatically from rolls.

The use of the proper type of press, the application of the proper amount of pressure to

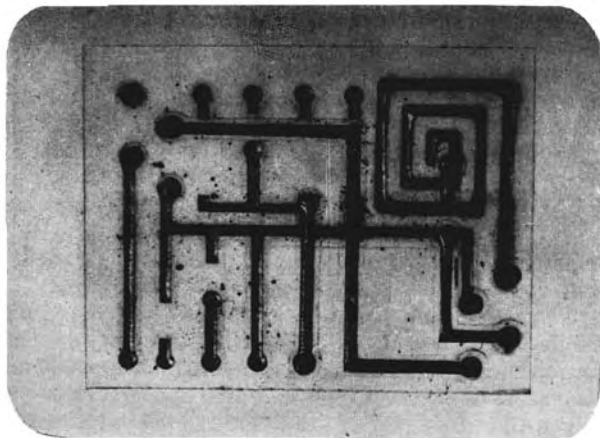

FIGURE 10.1. *Basic wiring grid and inductor imprinted on plastic base.*

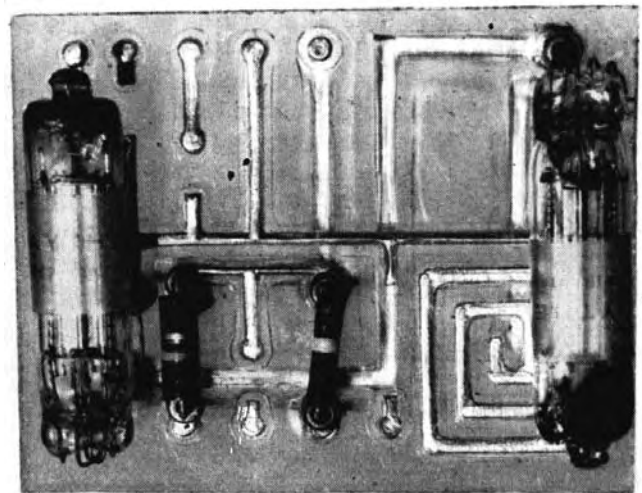

FIGURE 10.2. *Front view of a two-tube receiver with tubes and standard resistors added.*

¹⁸ By J. M. Ternes, Altair Machinery Corp., New York, N. Y.

the dies, the smooth dwell under pressure, and the controlled heat will result in an imprinted circuit inlay thoroughly embedded into and fused to the dielectric material of the base. The sizings employed to fuse the conductors to the dielectric vary according to the thermal cycles used to imprint the conductors.

Several tests have been conducted on sample assemblies (fig. 10.2). Current capacity tests were conducted for 4 hr, starting at 1 amp and advancing $\frac{1}{2}$ amp approximately every 5 min up to 9 amp. Nine amperes of current was held for 1 hr, then 10 amp for $\frac{1}{2}$ hr, 11 amp for $\frac{1}{2}$ hr, 12.5 amp for $\frac{1}{2}$ hr, and finally 13 amp for a $\frac{1}{2}$ hr duration. The test was discontinued

at this point since this was the maximum output of the power supply. It is obvious that the average electronic circuit does not have operating currents of this magnitude so there was no point in continuing this test. The inductor in the circuit has a value of approximately 0.15 microhenrys and resonated at 140 megacycles when shunted by 10 $\mu\mu\text{f}$ with a Q of 150.

Although hot-die stamping is only one of the many methods of printing circuits, we can produce a highly satisfactory imprinted circuit inlay on many types of plastics, phenolics, wood, fiberboard, etc., and we believe the method has many advantages.

11. Spraying Techniques for Producing Electronic Circuits¹⁹

"Spraywiring," a process for the rapid production of electrical circuits by metallizing, is one of the recently developed means for eliminating hand wiring in many applications. Instead of improving the method of installing conventional wiring, this process actually replaces drawn wire with an efficient conductor which is mechanically formed by mass production methods. In spraywiring, heated granular metal is sprayed through stencils into channels in dielectric chassis, thereby forming the basic wiring of the devices being produced. The process consists of three principal operations—the preparation of stencils, the insertion of eyelets and mounting of components, and sandblasting and metallizing.

In the first step a stencil is prepared in exact conformity with the basic wiring design to be produced, and is applied as a mask to the dielectric panel or chassis. A special "Scotch" masking tape has been developed by the Minnesota Mining and Mfg. Co. for use as a stencil material with this process. This type is lightly adhesive on the side applied to the panel, and has a surface sufficiently hard to withstand sandblasting and metallizing. Stencils made of this tape can be die-cut in continuous strips, and can be produced economically by firms equipped for such work.

Tape stencils are used only once, after which they are collected for salvage of the surplus metal deposited. When this type of stencil is used, it is advisable to allow a minimum separation of about $\frac{1}{16}$ in. between conductors.

Good results have been obtained experimentally with metal stencils faced with rubber coatings. These stencils are semipermanent; sandblasting cleans off the metal deposited during each spraying. These stencils are especially

suitable for the production of small, complex panels.

Metal eyelets, inserted in the panel prior to sandblasting, form terminals for the connection of component lead wires to the sprayed elements of the circuit. These eyelets are positioned so as to be metallized into permanent connection with the conductive strips when the latter are sprayed in. Eyelets are also used as connections between sprayed conductors on opposite sides of the same panel.

Standard sandblasting equipment is used to form grooves in the panel (fig. 11.1) coinciding with the stencil openings after the stencil is applied. The depth of these grooves must be at least 0.010 in. thick. The action of the abrasive forms grooves which are slightly recessed, and this characteristic contributes to the adherence of the sprayed conductors to the panel.

The metallizing technique and equipment are those of the Schoop process, familiar uses of which are the building up of worn bearing surfaces and the application of protective coatings of metal. The equipment is made by the Metallizing Engineering Co., Inc. of Long Island City. The metallizing gun (fig. 11.2) operates on acetylene, propane, or any commercial gas, and can be operated manually or mounted in a tool-post holder for automatic operation. A heavy duty gun known as the Metco Y Gun, uses $\frac{3}{16}$ in. diameter and smaller wire, and can double the spraying speed of other guns.

Panels are sprayed at a distance of 6 inches from the gun. Two passes are made (or the panel moves before two guns in sequence), at the rate of 1 foot per second. An average of 3.5 mils of metal is deposited on each pass, thus building up a thickness of 7 mils suitable for most applications. This technique of spraying will provide deposits of the proper porosity, and will insure that the base material is not

¹⁹ By Gordon Johnson, Spraywire Laboratories, Inc., Minneapolis, Minn.

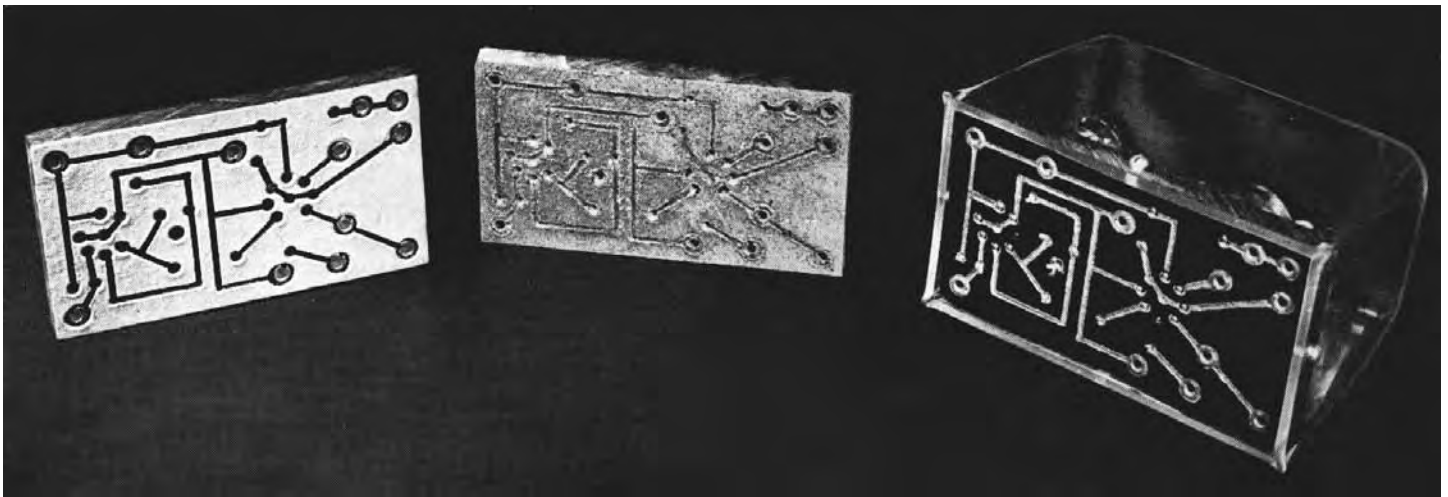

FIGURE 11.1. *Three steps in the production of a SPRAYWIRE circuit.*

At the left is a panel with stencil applied, prior to sand-blasting and metallizing. In the center is a panel which has been metallized, with the stencil still in place. At the right is a completed amplifier embedded in the bottom of the chassis. (Courtesy of Minnesota Mining and Mfg. Co.)

damaged by burning. Sprayed copper has a hardness of F78 to F79, and its specific gravity is 7.535. Due to their porosity, sprayed copper conductors are 10 percent higher in resistance than comparable drawn wire.

With the stencils now in use the practical minimum width of a sprayed conductor is about $1/16$ in. A width of $1/8$ in. or more, however, is preferable from a mechanical standpoint. Stencil openings of less than $1/16$ in. retard the uniform deposit of metal in the grooves. Above these minimums, sprayed conductors can be made as wide as may be required depending on the current they are to carry.

There may be some question as to the current carrying capacities of Spraywire in applications which require heavier currents than radio receivers. The thickness of 7 mils used in radio, with widths of $1/8$ to $1/4$ in. produces conductors unable to withstand heavy currents. When circuits require heavier current carrying capacities, deeper grooves and thicker deposits of metal must be provided. Suitable grooves can be formed in plastics by molding.

The dimension of conductors which is ordinarily varied in order to match wire sizes is the width. Corresponding wire sizes are determined by use of a table showing the conversion of square inches to circular mils, and adding 10 percent for porosity. In tests of current carrying capacity, a copper Spraywire conductor 7 mils thick and $1/8$ in. wide carried a current of 17 amp for several hours. When the current was increased to 20 amp, the conductor failed after 5 min. This conductor was therefore the equivalent of a No. 23 copper wire. Another sprayed copper conductor, 7 mils thick and $1/16$ in. wide, carried 8 amp for several hours. This conductor failed after 10 min when the current was increased to 10 amp.

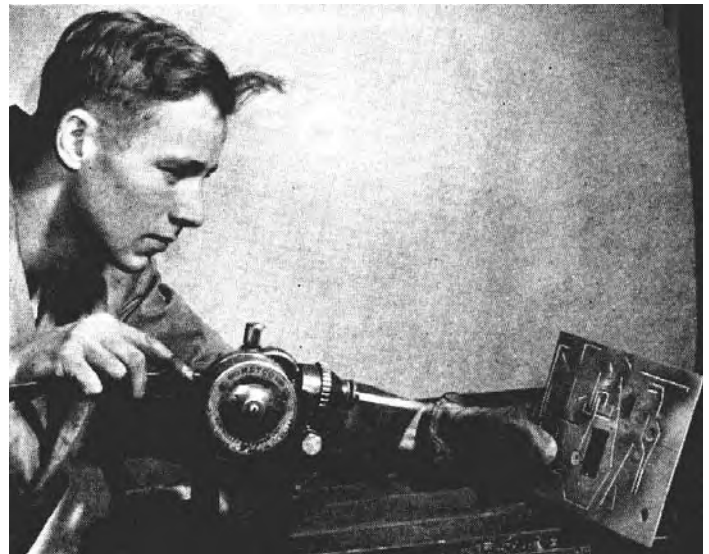

FIGURE 11.2. *Metallizing a panel.*

This illustrated a laboratory operation, and not a production set-up. Automatic handling equipment would be used in mass production.

It was, therefore, the equivalent of a No. 27 copper wire. These tests were repeated several times with identical results.

The bonding between sprayed metal and suitable base materials is excellent, even under vibration and shock. Sprayed metal adheres to rough or porous surfaces, and the sandblasting used with the process insures that the grooves into which the conductors will be sprayed are sufficiently roughened to provide a very strong bond. The heating of some base materials which are not sandblasted will also provide for strong bonding with the sprayed metal.

Forty-two alloys are prepared in wire form for use with metallizing equipment; these embrace all of the commonly used conductors, including those employed for high resistance

(such as Nichrome). The wide variety of base materials which can embody Spraywiring includes plastics, wood, ceramics, glass, and other insulators. Many types of plastics are suitable, including the general purpose resin phenolics and the polystyrenes of high dielectric strength. Plastic chassis can be premolded to desired shapes; the use of flexible stencils makes it possible to mask surfaces which are not flat and spray circuits onto them.

The most extensive research to date with the Spraywire process has been in experimental application to radio receivers. It is believed that a radio, with its different amplitudes of voltages, a-c/d-c, and radio frequencies, provides an excellent proving ground for this process.

A 5-tube a-c/d-c receiver incorporating "Spraywiring" was found to compare favorably with any standard receiver of comparable size now on the market. In the customary tests made in a shielded room, the receiver was lined up for peak performance in all stages, and a standard loop antenna was employed. A calibrated signal generator and a precision output meter were used to measure sensitivity and performance. Its sensitivity was 18 microvolts

for 500 milliwatts output through the entire broadcast frequency spectrum. Distributed capacities are reduced because of the thin character of the surfaces of sprayed conductors which are adjacent or in close proximity. No difficulties with stray oscillations were encountered. Shake tests up to 10 G's at 50 cycles failed to break or loosen any Spraywire connections.

One of the very important advantages possible with this process is the ease and simplicity with which devices made by this means can be serviced. The elimination of nests of wiring makes components readily accessible.

Extensive information on comparative costs must of necessity be derived from wider production experience than is now available for study. However, the speed of producing panels irrespective of the intricacies of their wiring lay-outs, the use of cheap materials made possible, the reduction of rejections for faulty wiring, and the numerous advantages of replacing manual work by an automatic process all point to the probabilities of greatly lowered costs. The Spraywire process is a potentially important contribution to the science of production.

12. Physical Aspects of Printed Circuit Conductors²⁰

I should like to make a few remarks about the structure of thin layers and what happens to layers, which are used in printed circuits as conductors, during the process of aging or during their lifetime.

Apparently, most of the conductors which are used have a granular nature. This granular nature is amply demonstrated by the fact that a silver conductor produced by the silk-screen process has a conductivity before firing up to about 30 percent of the conductivity of an equal amount of bulk silver. This indicates that, besides the grain insulation produced by the incorporated binder we have also some other phenomena, such as separation of the grains, which interferes with the conductivity. Now, after firing, the conductivity of the same silver layer is about 80 percent of a similar bulk conductor. There are data that have been supplied by Mr. Henry of Dr. Brunetti's staff, and I am using them as examples of the behavior of such granular conductors.

This behavior makes one think immediately of the behavior of other granular materials, and in particular the materials used in powder metallurgy. In powder metallurgy, too, one

begins with fine grains. These fine grains are compressed and after the compression they are fired and subjected to further mechanical treatment. During that process the resistance changes as well as the density. At my request Mr. Henry made a few measurements on the density of the thin silver layers which I previously mentioned. The density of the unfired layer with 30 percent conductivity was 40 percent of the density of the bulk material. After firing, the density was raised to 60 percent of the bulk silver which indicates that even when most of the binder is removed, there is still a rather porous layer.

We must ask, therefore, what happens to such a layer after aging. A similar question that can be asked is: What happens to very thin layers produced by other processes. If a metal is evaporated in a vacuum, the resulting thin layer is by no means a continuous one, but resembles the layer produced by the silk screen process in that it is inherently unstable and is subject to irreversible changes with temperature. If such a layer is examined under an electron microscope, it is found to be composed of extremely fine grains. The following figures

²⁰ By L. Marton, National Bureau of Standards.

will indicate the granular nature of such very thin layers and how the conductivity anomalies can be explained by the appearance of the layer.

At very high magnifications the individual grains of an antimony layer (fig. 12.1A) are revealed to be about one millionth of an inch in diameter. Note the voids between the individual grains of the layer and that the grains sometimes touch at only one point. The total conductivity is produced by the bridges formed between the individual grains. A layer of aluminum with approximately the same degree of magnification (fig. 12.1B) shows a similar structure. The scale in the figure is 1 micron (one 25 thousandths of an inch). The large particle is a dust particle. A similar case is an evaporated layer of gold. Although the individual grain size may change, the conductivity anomaly is given by the fact that the individual grains do not form a uniform layer but touch each other only at a few points where bridges are formed.

Now we ask what happens physically when we have such a complicated structure. Obviously, when we evaporate a metal, the metallic atoms first reach the substratum (the support) and condense on it. After condensation, however, these atoms will not remain in the same place. I mean by that, that although the underlying layers are more or less firmly bound, the top layer of atoms will not be bound completely. All layers are bound to the extent that the atoms cannot reevaporate unless the temperature is high enough. But even at room temperature or below, such metals as gold or even the most refractive metals, will still show a marked mobility of the uppermost atoms in the plane of the top layer. That mobility creates certain rearrangements of the atoms on the surface and that rearrangement is known under the name of recrystallization. I would like to discuss quite briefly by using table 12.1 how that recrystallization depends on different factors.

Table 12.1 indicates how, in powder metallurgy, the effect of compression and of heat treatment change both the resistivity and the density of materials. In very close analogy to what happens in a silver layer you see that the first sintering of a tungsten ingot produces a density of 12. I do not have any data about the resistivity for both the sintered and the formed ingot, but in the ingot formed at 3,400° C the density raises to 17. Then the mechanical drawing of the wire increases the density considerably until we reach the highest figure of 19.23 at 1 millimeter diameter. At that point, or even before, resistivity is lowered to 5.45 in arbitrary units. If we go further, something else happens and both the density and

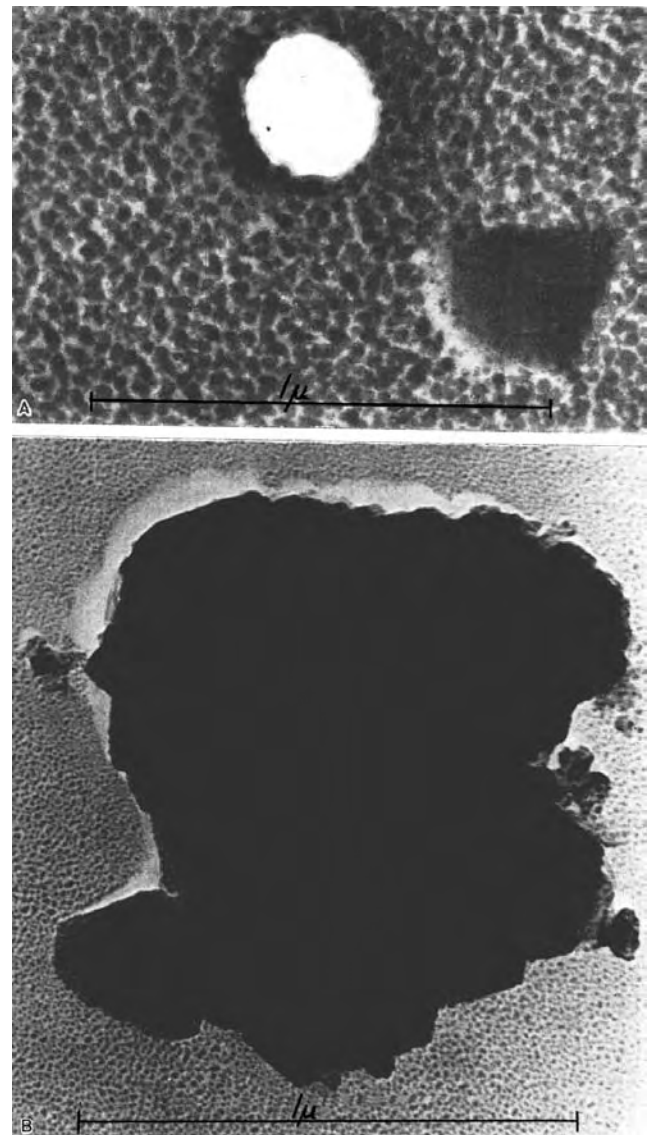

FIGURE 12.1.

A, Evaporated layer of antimony on collodion. The bright spot on the micrograph is a hole in the collodion film; the dark spot is a particle of dust.

B, Aluminum evaporated on collodion film. Note the structure of the aluminum surface, the shadow cast by the large dust particle in the center, and the aluminum top of the particle when the particle is thin enough to be transparent.

TABLE 12.1.—Tungsten (after Smithells)

	Diameter in mm	Density	Resistivity
Sintered ingot, 900°C. -----		12	-----
Formed ingot, 3,400°C. -----		17.5	-----
Drawn wire -----	5.6 × 5.6	17.0	6.13
Do -----	5.0	18.45	5.58
Do -----	4.0	19.00	5.48
Do -----	3.0	19.20	5.45
Do -----	1.0	19.23	5.58
Do -----	0.1	19.21	6.55
Do -----	0.03	18.95	7.27

resistivity will show reverse changes. The reason for that is that as we go to a certain degree of compression we close the voids in the compressed metal, but when we go beyond a certain degree of mechanical treatment we break up larger crystals into smaller ones and there the process is reversed. There is an obvious optimum somewhere.

In evaporated layers we have to investigate not only the type of material used, but also the nature of the substratum. The mobility of the atoms is not only dependent on the binding forces between the atoms of the same material, but also on the binding forces between the metal atoms and the atoms of the substratum. It is, therefore, necessary to distinguish between three classes. These three classes have been published in a paper by Picard and Duffendack in *The Journal of Applied Physics*, 1943. In this paper they make use of a theory by Lennard-Jones which was published in the *Transactions of the Faraday Society*, 1932. The following rough classification distinguishes between different recrystallization phenomena:

Class A—Surfaces which recrystallize with increasing temperature to form agglomerates separated by interstices which are much narrower than the diameter of the aggregates.

Class B—Same as class A but interstices are of same order of magnitude as diameter of particles.

Class C—Surfaces recrystallize to form relatively isolated crystals.

Table 12.2 indicates the behavior of a few metals with different substrata by using the

classifications A, B, and C. It shows very clearly that we need to know not only what temperature treatment is inflicted on the metal, but also exactly what substratum we are placing it on. A proper combination of the two will achieve better results than a search for better materials alone. Also, I would like to remark that all this indicates that there may be other methods for achieving an aging, particularly in cases of materials which cannot be fired at high temperature. I wonder if, on close analogy to the powder metallurgy method, it would not be worthwhile investigating to see if unfired metallic layers could not be aged faster by compression methods (hydraulic pressure or other) than can be done by temperature treatment alone.

TABLE 12.2.—*Recrystallization of thin layers of metals on different substrata*

Metal	Substrate	Class
Aluminum -----	{ Collodion -----	A
	{ Glass -----	A
Cadmium -----	{ Collodion -----	C
	{ Glass -----	C
	{ Copper -----	B
Copper -----	{ Collodion -----	A
	{ Glass -----	A
Gold -----	{ Collodion -----	A
	{ Glass -----	A
Magnesium -----	{ Collodion -----	A
	{ Glass -----	A
Zinc -----	{ Collodion -----	C
	{ Glass -----	C
	{ Aluminum -----	B
	{ Copper -----	B

13. Mechanization of Electrical Wiring²¹

Over the past several years there has been a steady trend from electrical controls to accomplishing the same service by electronic means. In a great many instances greater accuracy could be obtained by electronic means plus the very attractive feature of flexibility. Early experiences in this direction revealed that the advantages to be gained from electronic design were sometimes outweighed by an increased cost in production. Accordingly, Minneapolis-Honeywell undertook an investigation of new means for mechanization of electrical wiring to reduce this cost. A large proportion of the research that has been done to date on mechanization of electrical wiring has been done on its application to military equipment. This application puts a premium upon small size and weight. In many other applications size and weight are not the predominating require-

ments. In such cases the mechanization of electric wiring is being used because it is economically desirable. After consideration of several methods, three appeared to be most feasible. These were (1) circuits stenciled on steatite, a development which was available commercially; (2) stamped wiring from a metal plate; and (3) sprayed metal wiring onto a premolded panel.

All of these methods have some inherent advantages: (1) the errors of wiring are reduced to practically zero as far as the wiring of the circuit is concerned (any error that shows up is caused only by faulty components such as transformers, relays, etc.); (2) the speed of wiring on the assembly line may be increased 50 to 75 percent depending on the type of circuit used and the kind of mechanization used; (3) lead wires may be pre-spaced in circuits where feedback, pickup, and other interactions affected by the relationship of the lead wires

²¹ By Ralph T. Squier, assistant director of research, Minneapolis-Honeywell Regulator Co., Minneapolis, Minn.

dictate the fidelity of the instrument; (4) mechanized wiring automatically solves the problem of properly protecting a wired circuit from vibration, etc., since it is unnecessary to elaborately cable and tie the connecting wires; and (5) the problem of insulation break-down is eliminated because it is possible to locate leads in a desired manner.

The use of complete interstage coupling circuits (fig. 13.1) purchased from Centralab has reduced cost by 25 percent. The possibility of the elimination of error can readily be seen in this instance.

A complete amplifier (fig. 13.2A) has been made using the stamped wiring technique believed to be first used by Kellogg Switchboard & Supply Co., Chicago, Ill. A single flat stamping or grid made of silver plated 0.025 in. brass contains all connecting leads plus the necessary links to support the grid as one piece. To accomplish connection to the grid, all component terminals are brought to one common plane. The grid, which fits in only one position, is laid down on the terminals and all terminals soldered to it. The final step is the clipping away of those parts of the grid which were used only as supports and are not to be used as electrical connectors. This is done with a special instrument that cuts all supporting bars at once. This amplifier is in regular production and the techniques shown have helped in making it a more economically attractive item.

An amplifier with sprayed wire leads (fig. 13.2B) is still in the research stage. Grooves were made in the base, first by milling and later by molding, into which the metal was sprayed. It was found that the metal impinging upon the lands between the grooves could be easily wiped off. There were, however, some problems that immediately presented themselves concern-

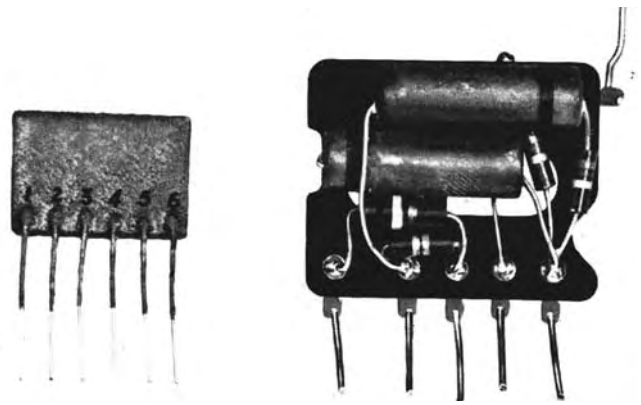

FIGURE 13.1. Interstage coupling unit—stenciled and conventional.

ing spacing, width, depth, bottom surface, and shape of the groove.

Certain minimum separations between leads must be maintained in electronic circuits in order to eliminate electrical leakage. Using a groove width of 1/16 in., even with miniature tubes having closely-spaced pins, resulting separations were within these limits. This groove width is more or less arbitrary, being wide enough to allow ample room for spraying to the bottom of the groove and to provide sufficiently high conductivity while leaving adequate spacing between leads.

A series of tests were conducted to determine optimum groove depth for adhesion of the copper to the base. This depth seems to be quite critical and should be maintained at 0.040 ± 0.005 in.

Measurement made on the bonding of the copper to the bottom of a molded plastic groove shows conclusively that some sort of roughening is desirable. Longitudinal and diagonal ridges gave much better results than did a smooth surface. To determine the bonding of

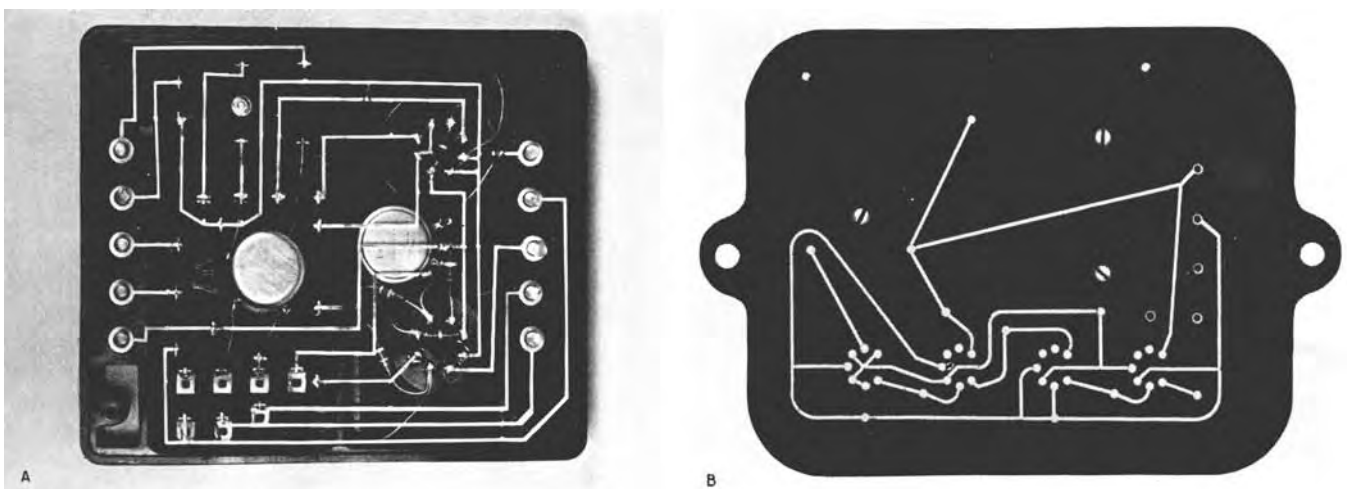

FIGURE 13.2.

A, Stamped wiring applied to an amplifier. B, Bottom view of amplifier showing sprayed wiring on plastic panel.

the copper to the panel, a small circular hole of the same width as the grooves was drilled through the panel prior to spraying. A steel pin was inserted through this hole flush with the bottom of the groove. After spraying, this pin was removed and one of slightly smaller diameter inserted in the hole and the force required to dislodge the copper conductor was measured. The average of these forces for smooth grooves was 100 gm and for roughened grooves, 600 gm. The groove must have a sharp edge at its top to automatically cut the lead off from the flashing at the time of deposit.

After spraying, the plastic and copper are painted with a mixture of Durez and varnish which further improves the adherence of the copper to the plastic.

Sprayed copper leads in grooves on a plastic base were subjected to the following conditions without detectable change in electrical or physical characteristics: (1) Temperature variation in 10 cycles from -65°F to $+160^{\circ}\text{F}$; (2) pressure variation from normal atmospheric to that prevailing at 50,000 ft; and (3) vibration in a 0.020 in. diameter circle inclined at 45° for 1 hour each at 10, 30, and 50 cycles per second.

Amplifiers constructed with sprayed copper leads in grooves on a plastic base have been subjected to all the conditions noted above and to extremes of humidity and have operated under moderate conditions for months with no change whatever that could be attributed to deterioration of the sprayed copper leads.

14. Die Stamped Wiring²²

For years engineers have worked to develop something resembling packaged wiring. Early electrical and electronic equipment used rigid bus-bar that was difficult to handle and harder still to keep in place during shipment. This soon gave way to flexible wiring and cabling techniques, but even the latter required many individually soldered joints. During the war

printed circuits came into use. Since then cast conductors somewhat reminiscent of processes tried in this country back in the 1920's, have been introduced in England.

A number of new packaged wiring ideas are in the experimental stage. Some are well along in development. One such idea involves stamped wiring, originated by A. W. Franklin, president of the Franklin Airloop Corp. of New York, which lends itself to mass production methods since a basic wiring package can be turned out for manufacturers of many types of electronic equipment. Alterations in the basic package are readily made by means of dies, so that 90 percent of the wiring within the average device can be stamped out. Furthermore, most component parts may be connected to the wiring in one operation by dip or induction soldering. Substantial savings in material, in alignment and testing, as well as in assembly, seem likely.

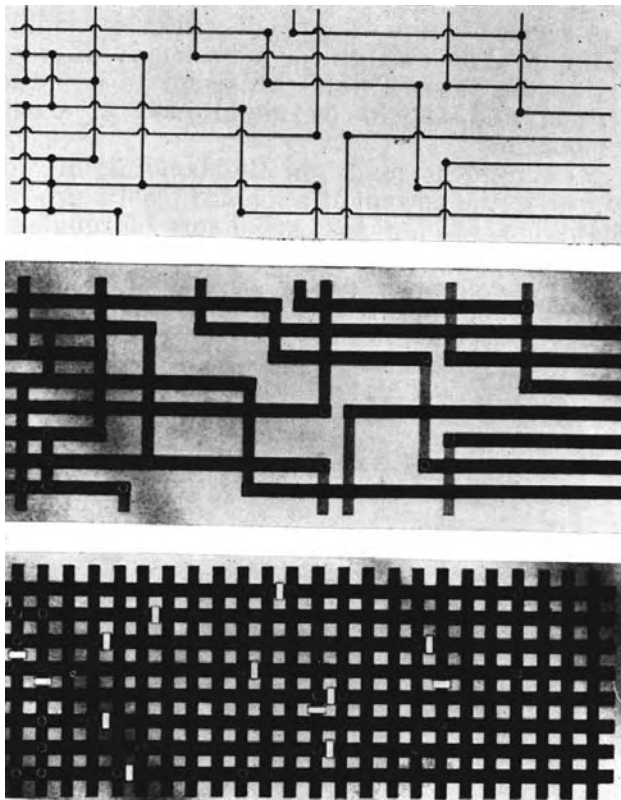

FIGURE 14.1. Development of stamped wiring panel (center) from schematic diagram (top). (Bottom) the same circuit using a standard die.

Basic Idea

Basically, stamped wiring consists of a thin sheet of insulation with a series of parallel conductors running in a horizontal direction on one side and a series of vertical conductors on the other side. Interconnection between horizontal and vertical conductors is accomplished by punching through the insulation intervening between such conductors and then joining them by means of an eyelet or pin. A method of interconnection which requires neither form of fastening, just pressure and heat, is also under development.

A stamped wired panel may be developed from any schematic wiring diagram (fig. 14.1).

²² By W. W. MacDonald, managing editor—"Electronics." Presented by J. B. Straughn, Franklin Airloop Corp., New York, N. Y.

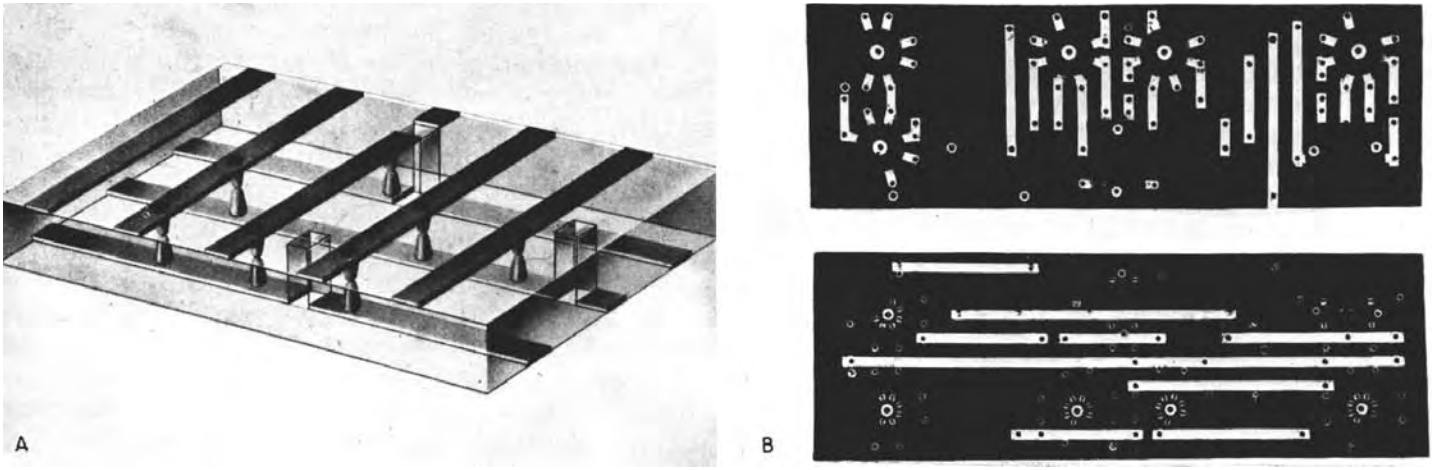

FIGURE 14.2.

A, Stamped wiring system for use with a simple welding process or resistance soldering method to provide contacts between horizontal and vertical conductors. B, Stamped wiring panel including sockets, for five tube superheterodyne receiver.

The top illustration shows the circuit with dots indicating connection points and arcs indicating crossover. The center illustration shows stamped wiring on a Bakelite panel, approximately 1/16 in. thick—horizontal conductors stamped on one side and vertical conductors stamped on the other side. The lower illustration is the same circuit developed from a standard die which would stamp a series of horizontal conductors on one side, vertical conductors on the other, in grid formation. Eyelets through the panel make the electrical connections indicated on the schematic. Slots perforated completely through the panel open the connections where necessary. Flexible dies could be made to perforate the holes for the eyelets or pin connections and slots for the open connections. It can readily be seen from these illustrations that any electrical circuit can be developed from one of these panels.

A further development (fig. 14.2A) indicates a simpler and less costly arrangement of making connections. Having holes and the slots perforated in the insulated panel before the stamped wiring is superimposed permits electrical contact to be made by a simple welding process or resistance soldering method. This eliminates the use of eyelets as the vertical and horizontal conductors are drawn together through holes in the insulating panel and soldered together. The illustration gives an exaggerated view as to depression required for connection points. In actual practice, the conductors would be drawn approximately 1/32 in. through the prefabricated holes on the insulated board. Such a depression can be formed at the same time that the wiring is stamped. The copper used for the stamped circuit is approximately 0.005 in. thick and can be varied between 0.002 in. and 0.010 in. depending on the conductivity required. The copper can be tinned for electrical resistance soldering. Tinning would not be necessary for spot welding.

Where connection to a single horizontal or a single vertical conductor is desired, without interconnection, an eyelet or pin may be punched into the selected conductor at a point which causes it to miss metal on the reverse side. Where breakup of a single horizontal conductor or a single vertical conductor into several horizontal or vertical conductors is required, this may be accomplished by the simple process of cutting the conductors at one or more points along their length or height.

Electronic equipment circuit diagrams consist essentially of horizontal and vertical lines, with cross-overs and interconnections. Stamped wiring consists of horizontal and vertical conductors, with the insulation between them constituting an inherent cross-over, and eyelets, rivets or some other type of fastening providing interconnection. Thus it is readily possible for an engineer-draftsman to make the transition from schematic to stamped wiring. Location of eyelets or pins, points at which conductors should be cut, and placement of parts is also planned at this time.

The type of fastenings used for interconnection of conductors, whether eyelets, pins, or the conductors themselves are used as terminals for component parts, and whether short conductors are stamped out that way or produced subsequently by stripping away unused metal from longer conductors depends upon what the equipment assembler wishes to buy, and upon what the supplier of packaged wiring ultimately finds it most desirable to deliver. Developmental work is still proceeding at a pace that suggests that such details will soon be standardized.

Stamped Wiring Deck

Completely wired panels (fig. 14.2B) for radios including sockets for tubes and IF transformers have been made using stamped wiring.

Note that a socket contact was developed having tubular soldering tails instead of the usual standard flat type wrap-around contacts. Thus, for radio or electronic devices, all that would be necessary to complete the device would be to drop small components to the wiring deck through hoppers or fixtures. The bent wire terminals of components would fit into the hollow pins of the contact tails or tubular pins and be completely soldered in one dip-soldering operation. This would be a similiar operation to that now performed in soldering tube socket bases. In this way, the number of individually soldered points in a radio receiving set would be reduced from approximately 150 to the comparatively few required for soldering main components such as tuning capacitor, volume control and speaker.

It might be well to point out at this time that it would be advantageous to use small flat printed components as part of the circuit. A combination of stamped wiring for the main part of the circuit and printed circuits embodying components would be ideal in many devices.

Performance

Performance tests are being made on equipment using stamped wiring. At this writing it appears that little or no circuit modification is required where it is to be employed. Developmental radio receivers perform quite as well as conventionally wired sets with respect to sensitivity and selectivity. There is reason to believe that the fixed nature of the wiring, plus the fact that necessarily careful planning of both wiring and placement of parts, may make it possible to operate tubes nearer the spill-over or hot point in production models, with resultant improved performance.

Alinement of circuits in production should be materially simpler than where conventional wiring is used, since wiring stamped out by a die will not vary from set to set. This factor should prove of particular interest to manufacturers of television equipment.

Television

Development work on stamped wiring now embraces television receivers in which approximately 500 soldered joints are required. By using a combination of stamped wiring and stamped inductance the development work on a push-button switch covering the 13 television channels is now practically completed. Instead of winding 30 individual inductance coils, 3 parallel transmission lines (each carrying 13 channels) and the wiring for r-f mixer and oscillator tubes is stamped on an insulated panel in one operation.

Method of Manufacture

The method used for stamping the wired circuits of a complete receiver embodying stamped wiring and the Franklin Airloop is the same as that used for stamping the antenna or inductance coils. The stamped wiring decks can be produced at the same rate as a machine producing AIRLOOPS. This machine produces AIRLOOPS at a rate of 20 per minute and is especially designed so that the copper is automatically fed through the machine while the insulated panels, stacked up in a hopper, are inserted under a hot die so that on each cycle of operation a complete wiring panel circuit is stamped. The scrap copper is ejected at the other end of the machine.

Sheets of single-X 1/16 in. Bakelite punching stock, similar to that used in the manufacture of wafer-type sockets, are sheared to 3 × 9 inch size. A roll of 0.005 in. pure electrolytic-type oxygen-hydrogen-free copper, tinned on both sides, is coated on one side with U. S. Rubber's Kotol thermoplastic cement.

Insulation and copper are fed to a 150-ton Standard automatic toggle press, containing a shearing and forming die. When the press is operated the die cuts the copper into conductors 5/32 in. wide, with equal spacing between conductors and presses their edges and ends 3/1,000 in. into the insulation. The die is heated electrically to 230° F and softens the insulator sufficiently to facilitate locking the conductors securely in place. The heat simultaneously sets the thermoplastic cement so that the conductors are both mechanically locked and cemented to the insulation.

The deck next goes to a punch press, where all holes for eyelets and pins are knocked out in a single operation. The holes in this particular case are 96/1,000 in. in diameter and take pins similar to those used in the manufacture of octal tube bases. In still another press, eyelets and pins flow from hoppers through feeder tubes to deck holes, as in the manufacture of tube sockets, and are clinched in place. Heating by conduction may be used to sweat conductor and eyelet and/or pin tinning together. The stamped wiring deck is now complete and ready to receive component parts.

Cost

Cost determination must wait until a sufficient number of units embodying stamped wiring are manufactured to permit accurate cost accounting, since material, and alinement and test labor, as well as assembly labor, is involved. Then too, die cost will vary depending upon the size of the deck required, upon the relative complication of the wiring to be stamped, and

upon the volume achieved by supplier and assembler.

Substantial savings should be possible. One clue is the fact that Franklin believes it will be possible to supply stamped wiring decks for 5-tube table model radios, with tube sockets built in and ready to receive component parts, for about double present cost of sockets.

Die Stamped Cable Wiring

A more recent development (fig. 14.3), makes it possible to replace conventional wire cables with a die-stamped wire conductor panel of various lengths, ending in terminals for making soldered connections to other parts of a switchboard or communication panel. While the conductors for the main part of the cable can be reduced in size to give possibly 50 per in., they could also be branched off from either end in terminals or conductors of increased width. This is accomplished by ending the main part of the cable die in an acute angle (30° in this particular case) which makes the terminals or branch conductors twice the width of the conductors in the main part of the cable. Thus complete panels can be formed leading conductors directly to other points of connection.

The new method of wiring may be used in the following applications: dashboards and panel boards for automobiles, airplanes and ships; flat type disk commutators; multi-pole switches; hearing aids; annunciator boards; intercommunication units; television r-f coils and i-f transformers; FM i-f and discriminator coils; and electronic circuits combining wiring, inductances and capacitors.

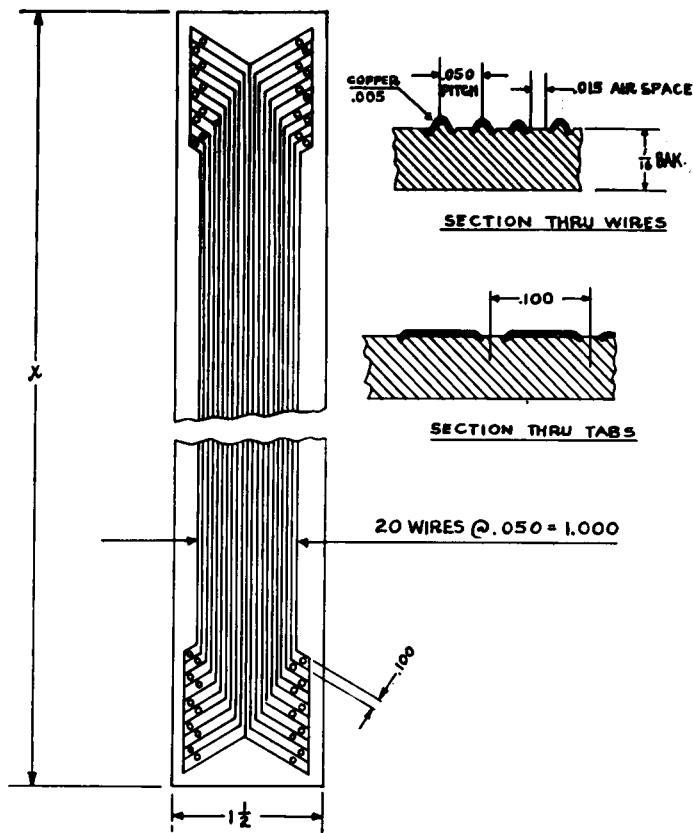

FIGURE 14.3. Die-stamped wire panel for replacing conventional cables.

An interesting development is the fact that the stamped wiring method can be applied to a molding process which permits all of these devices to be made on molded Bakelite or low-loss materials, such as polystyrene, etc. The process is especially adaptable to metal insert molding as one sheet of metal inserted into a mold can be cut and formed into a large number of smaller inserts.

15. Printed Circuit Production^{23, 24}

The techniques employed by the Kenyon Instrument Co., Inc., differ from others described in this symposium principally in that the starting point is an insulating base material that is completely covered with a conductive layer. Unwanted portions of these conductive layers are progressively removed until only the desired surface pattern remains. The end results do not differ markedly from those obtainable by any of the previously described methods. While we do not wish to claim any outstanding advantages either in economics or performance, there are two features that merit special consideration. These are the dimensional precision with which the "wiring" may be laid down and the flexibility of the process in its ability to reproduce conductive patterns upon a wide range of sizes, shapes, and materials. These

advantages are made possible through our use of photographic and optical techniques.

The problem of applying conductive coatings to insulators is a matter of first concern. In our case, which involves "all over" coating prior to production of the pattern, the problem is somewhat simplified and some methods of application not readily applicable to other processes of circuit production become available for our use.

²³ By Clifton M. Tuttle, vice president in charge of research and engineering, Kenyon Instrument Co., Inc., Huntington, Long Island, N. Y.

²⁴ EDITOR'S NOTE: Since the receipt of this paper a new development involving the use of commercially available films as the stencil matrix has been brought to our attention by Kenyon. In this process a stencil is formed photochemically, the finely divided conductor suspended in a solvent is applied by spraying, and the conductive pattern is then finally transferred from the commercial film to a plastic or possibly ceramic base. This method will be described in the forthcoming technical journals.

The Kenyon company has conducted a systematic survey into the commercially available application techniques and has devised some others which may be new. Some of the more significant results are presented in table 15.1.

Circuit Patterns On Metallized Insulators

Given an insulator whose surface is covered by a conductive coating of uniform adherence, surface quality, and chemical nature suitable for the certain end product, the task of removing the unwanted portions so as leave the desired wiring networks may be approached in two distinct ways:

One of these is mechanical—by sand blasting. The other is chemical—by acidic or basic etching. Either method is practical and both are capable of producing precise results. Which method to use depends upon several factors which will become apparent as this discussion progresses. In some cases, a combination of both techniques is indicated.

For either method to become operative it is

first necessary to produce upon the metallized surface a stencil pattern that will act as a resist for the sand blasting or the chemical etching. Other papers have discussed various mechanically applied stencils. Our techniques employ photographic resists as stencils because of the dimensional accuracy of the pattern, the versatility of application to any contour and size of surface, versatility in changing from one pattern to another, and the dimensional accuracy of registration of the pattern with respect to location on the piece.

Practically, whether the photographic stencil is used as a sand blast or chemical resist, the material must have certain chemical and physical attributes. The material must be in solution and possessed of a viscosity allowing it to be evenly spread over the surface. Its photochemical nature must be such that it may be rendered either soluble or insoluble in some reagent by the action of light or ultraviolet radiation.

Without going into the chemistry of such materials in any detail, it is possible to list in tabular form the types and attributes of a few of the more useful materials. The ma-

TABLE 15.1.—*Properties of various conductive coatings*

Application process	Conductive Material	Base Material	Adherence	Surface Quality	Uniformity of thickness	Thickness	Resistance Ohm-Cm
Vacuum evaporation	Ni-Cr	Bakelite	Excellent	Mirrorlike	Percent 1	In. 0.00001	2.6 x 10 ⁻¹
	Ni-Cr	Bakelite	do	do			
	Ni-Cr	Glass	do	do	1	.00005	5 x 10 ⁻²
	Ni-Cr	Polystyrene	Fair	do	1	.00001	2.5 x 10 ⁻¹
	Ni-Cr	Steatite	do	do	1	.00001	2.5 x 10 ⁻¹
	Ag	Bakelite	do	do	1	.00001	1.2 x 10 ⁻¹
	Ag	Glass	do	do	1	.00001	1.1 x 10 ⁻¹
	Sprayed metal	Zn	Steatite	Good	Porous	25	.002
Zn		Ground Glass	Poor	do	25	.002	5 x 10 ⁻²
Zn		Bakelite	Fair	do	25	.002	5 x 10 ⁻²
Al		Glass	Good	do	25	.002	2 x 10 ⁻¹
Al		Steatite	Excellent	do	25	.002	2 x 10 ⁻¹
Low melting point alloy (flowed on)	Zn-Pb-I	Bakelite	Excellent	do	25	.001	1.0
	Zn-Pb-I	Glass	do	do	25	.001	1.0
	Zn-Pb-I	Lucite	Poor	do	25	.001	1.0
Silver or gold precipitation	Ag	Bakelite	Fair	Mirrorlike	10	.0001	8 x 10 ⁻⁵
	Au	Bakelite	Fair	do	10	.0001	3 x 10 ⁻⁴
Graphite Deposition	C	Vinylite	Excellent	Smooth	2.5	.0005	2 x 10 ²
	C	do	do	do	2.5	.0005	2 x 10 ²
	C	Polystyrene Cellulose Acetate	do	do	2.5	.0005	2 x 10 ²
Electro-chemical deposition	Cu	Any of above coated with any metal but Al	Excellent	Smooth after buffing	5	up to .002	
	Ag		do		5		
	Cr		do		5		
	Ni		do		5		

NOTE—The following is given as a brief explanation of column 1:

“Vacuum evaporation” refers to the high vacuum technique now made comparatively inexpensive by quantity production methods.

“Sprayed metal” refers to the application of molten metals either from wire or powder.

“Low melting point alloy” refers to materials similar to Woods metal, especially those having a high indium content. These platings are, of course, useful only in situations where the ambient temperatures are below the melting point.

“Silver or gold precipitation” refers to the technique of mixing two sprayed-on solutions, one containing metal halide salts and the second containing a reducing agent.

“Graphite deposition” crystalline carbon is precipitated from solution by newly developed techniques.

“Electrochemical deposition” refers to the well-known plating technique using a metallic salt as an electrolyte.

Column 4—“Adherence” needs an apology in that it is qualitative rather than quantitative. “Excellent” means the coating cannot be scratched off with the finger nails, lifted off by Scotch tape, or rubbed-off with vigorous treatment with a pencil eraser. “Good” means that the coating fails in the last two “tests”. “Fair” means that it fails on the third. “Poor” means that it fails on all three. A yet unpublished paper describes an apparatus that might well yield significant quantitative tests.

Column 5—“Surface quality” is also qualitative. The standard instruments of surface specification such as the Brush Analyzer are probably too refined for the job.

materials in table 15.2, with the exception of number 1, are all of a nature such that the latent image produced by exposure becomes insoluble in the exposed areas but is dissolved and removed in the unexposed areas when subjected to the reagents in the second column. The exposures listed in the last column are only rough approximations. The values are based upon a visual illumination value with the radiation being produced by an H4 mercury capillary lamp. Actually the most photographically effective part of the radiation lies in the ultra-violet region and this is not well specified by the meter-candle unit.

TABLE 15.2.—Photomechanical resists

Material	Solvent	Use	Approximate exposure in meter candle seconds to produce latent image
Experimental photosensitized colloid	5% NH ₄ OH in 130° F. H ₂ O	Sandblast resist.	6.3 x 10 ⁵
Bichromated gelatin treated with glycerine	H ₂ O	Sandblast resist.	2 x 10 ⁶
Shellac based cold top enamel	C ₂ H ₅ OH with dye	Nitric acid resist.	1.7 x 10 ⁶
Bichromated glue	H ₂ O	Nitric acid resist.	1.8 x 10 ⁶
Experimental cold top enamel	Higher alcohols	{Alkali resist; mild acid resist; electroplating resist.	1.9 x 10 ⁶

In producing circuit patterns on the metalized insulators the following steps are carried out: (1) The part is covered with a thin (0.0004 in.) layer of asphalt; (2) the photosensitive resist is applied, (materials 1 or 2 of table 20.2 are used if the metal layer is of a nature best removed by sand blasting); (3) the part is exposed through a black and white photographic transparency bearing an image of the circuit pattern; (4) the whole part is immersed in the appropriate solvent leaving the resist layer untouched in the areas to be protected; (5) the part is dried and subjected to a blast of fine abrasive, i.e. 1,300 mesh silicon carbide, until the metal layer has been removed (this process takes from 5 seconds to a minute depending upon the layer-thickness, adherence, and air pressure of the blast); (6) the resist layer remaining over the conducting pattern is removed. Use of the chemical etching technique eliminates step 1 of the foregoing, substitutes a different solvent in step 4, and substitutes a chemical bath for step 5.

On the whole the chemical method proves somewhat more economical and convenient than the sand blast process, and it leaves the base material unabraded and extremely smooth. Its universal use is, unfortunately, limited by the fact that many of the conductive layers that show the best adherence to the base material are the least affected by the oxidizing reagents such as nitric acid.

Most of these layers such as nickel and chromium are readily attacked and removed by the halogen acids HCl, HF, HBr, and HI. For these acids, we have not yet devised a satisfactory photosensitive resist and have found none on the commercial market. This situation, however, does not prevent the use of the chemical method though it does require an additional step in the preparation of the conductive layers.

In dealing with one of the strongly adherent layers such as an evaporated coating of chromium and nickel, a thin coating of silver is deposited either by electroplating or by evaporation. We then have a material that can be treated by the standard chemical etching process so that the desired pattern can be produced in the silver layer superposed on the base metal. The whole part may now be treated by one of the halogen acids. Since silver is unaffected by this treatment, the silver image acts as a protective resist for the underlying base metal and the final desired result of a circuit pattern in the strongly adherent nickel or chromium layer is achieved.

Advantages of the Photographic Technique

Final results of a high order of precision are possible. It is possible to reproduce with very little loss, most of the detail of which the modern fine grain photographic emulsion used as the printing negative are capable. The end result is perhaps best expressed in the customary photographic terms of resolving power.

Starting with a chrome nickel evaporated coating on glass, we have been able with no difficulty to reproduce a line pattern on grating having eighty lines to the millimeter. Probably this is not the limit, though with thicker metallic coatings—of the order of 0.001 inch—it is doubtful whether more than one-tenth of this resolving power could be achieved.

Optical Printing

On flat surfaces, good definition with resultant high resolving power can be achieved by contact printing. The photographic transparencies can be made either on Eastman Kodalith film or on process glass plates. A vacuum print-

ing frame is desirable to assure good contact.

When the part is cylindrical or of some shape other than flat, optical printing is preferable and sometimes necessary. An optical printer suitable for the job of printing on the cylindrical surface of a tube envelope consists of a slit source of light, a high quality projection objective, a means for moving the negative uniformly past the slit, and a means for rotating the tube with uniform surface speed. The speed of the negative traverse is so adjusted that the optical image of the pattern moves at the same rate as the sensitized surface of the

tube so that there is no relative movement between the image and the tube.

Acknowledgment

A large part of the work of this company in studying these techniques has been made possible through a development contract with the Squier Laboratory of the Signal Corps. The author wishes to thank members of the Squier Laboratory staff and in particular Mr. F. K. Priebe for his many helpful suggestions throughout the course of this work.

16. Prefabricated Components for Printed Circuit Application²⁵

The production of electronic and radio equipment is today almost entirely an assembly operation with the fabrication of components being done in plants which are completely independent of the equipment manufacturer in organization and ownership. Even when equipment manufacturers design and engineer special components, production is frequently subcontracted to the component manufacturers. In the early days of the radio industry, however, it was necessary for radio manufacturers to fabricate many of their components. There were no large scale specialists in the manufacture of such items as resistors, coils, condensers, and the like. The development of mass production methods in the industry was accompanied by, and indeed was made possible by, the separation of equipment manufacture from component manufacture.

The major consequence of the type of specialization which has evolved is the production of very large numbers of standard components at low cost and with continued improvement in quality. The amount of know-how required for the manufacture of components has become quite formidable. Equipment manufacturers no longer possess the organization, the personnel, the know-how, or the facilities for manufacturing components. Even if they did, their own requirements are usually not large enough to permit a production volume which results in a cost as low as that charged by the large scale manufacturers of components such as resistors, capacitors, and coils.

This situation is not substantially altered by the use of printed circuit techniques. The mass production of printed components, such as re-

sistors, of adequate quality to required tolerances is a difficult art. Highly specialized knowledge and experience are still prerequisites. It must therefore seem to equipment manufacturers that the introduction of printed circuit methods into their plants would be a throw-back to the primitive era of the 1920's.

Nevertheless, there is a great deal of interest in printed circuits because of several outstanding possible advantages²⁶, particularly compactness, lower wiring and inspection costs, and simplified production systems. If the radio manufacturer found it possible to use these advantages without forcing upon him the new and serious problem of component fabrication, then printed circuit procedures would undoubtedly secure widespread adoption.

One way of solving this problem is by prefabricating components designed for subsequent insertion into printed circuits. The two most important specifications for such components are miniature size and thermal stability. The first requirement is obvious, and the second is necessary for two reasons. In the first place, the compactness of printed circuits automatically results in high ambient temperatures of operation. The heat from the electronic tubes alone is frequently sufficient to heat all the other elements to temperatures far above the limits ordinarily set for their satisfactory operation. Secondly, in order to avoid any loss in compactness and to secure the full production advantages of printed circuits, prefabricated components must be directly attached to the printed conductors without the intervention of wire leads. Therefore, such components must be stable at soldering or welding temperatures.

²⁵ By M. U. Cohen and Lewis Balamuth, Balco Research Laboratories, Newark, N. J.

²⁶ C. Brunetti and R. W. Curtis, Printed Circuit Techniques, N. B. S. Circular 468 (1947).

Balcohm Resistors

With the support of the Signal Corps, which has its own requirements for miniature components stable under wide extremes of temperature, the Balco Research Laboratories has for some time been developing resistors, capacitors, and inductors to meet the military demands for high thermal stability and miniature dimensions. The novel materials and fabrication methods employed in meeting these requirements may also be utilized in the manufacture of prefabricated components which are very well adapted to printed circuit assembly.

The components which we have developed further lend themselves to belt-line circuit assembly operations which in many respects promise to be even simpler than those currently in use for standard circuit assemblies in that they may be made almost automatic. Thus, the manufacture of electronic equipment can continue to be an assembly process and the advantages of printed circuit techniques can be obtained without the necessity for learning the difficult art of component manufacture.

“Balcohm” resistors (fig. 16.1), employ a nonmetallic and noninductive resistive element which has high thermal stability. Although most of the experimental units have had a resistance in the range from about 100 ohms to 5 megohms, we have prepared resistors whose value is as low as a few ohms and as high as several hundred megohms or more. Standard commercial tolerances may be maintained. Because of its high stability, this type of resistor is expected to have significant application in the precision resistor field, that is, where 1 or 2 percent tolerance components are installed and expected to maintain their values over long periods of time.

The resistor composition is generally applied as a very thin coating to an insulating support. This support may be made of glass, fused quartz, ceramic, mica, or other material which has the requisite insulation resistance and thermal stability. The body may be of practically any shape or size, and coating methods

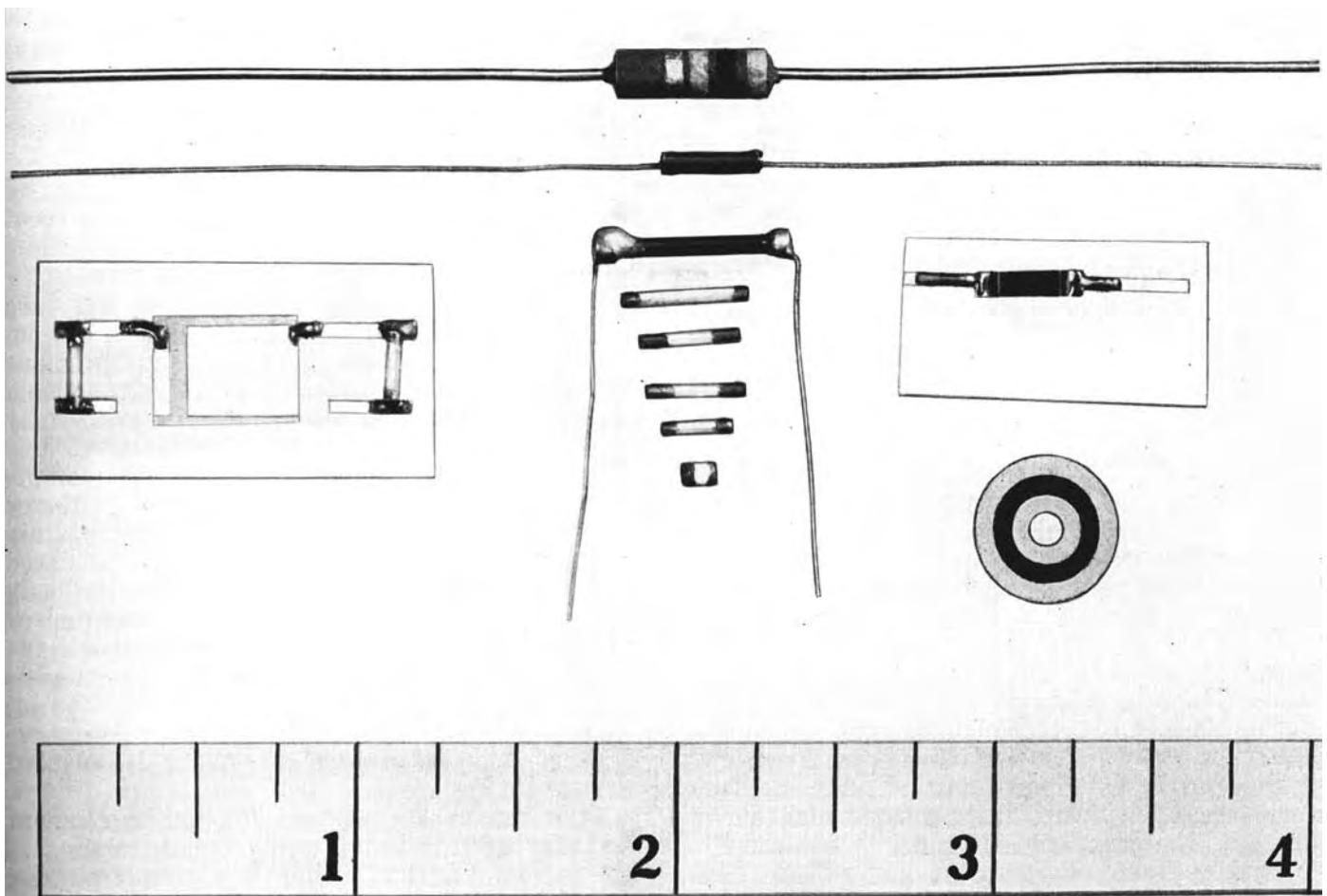

FIGURE 16.1. Reading down (center): Commercial $\frac{1}{4}$ watt resistor; Balcohm hermetically sealed axial lead resistor; Balcohm hermetically sealed radial lead resistor; resistors with body ends tinned for direct soldering.

Left, printed circuit with two resistors and one film capacitor soldered direct to printed wiring. Right, strip resistor soldered to printed wiring. Disk resistor for coaxial application.

have been developed for the fabrication of tubular, flat strip, disk, and other types of resistors. Miniaturization in size may be carried to any desired extent, resistors having been constructed whose total volume is 0.0001 cubic inches. Indeed, coating methods have been developed which permit the construction of two or more resistors on a single miniature form. Thus the interior and exterior surfaces of a tubular form or the opposite faces of a flat strip may carry two independent resistive films, with separate leads or terminals for both resistors.

Tubular resistors may be internally coated, and result in an insulated body resistor of excellent space factor. Where desired for special applications such resistors may be hermetically sealed without requiring any increase in size because the insulating form itself serves as the sealed envelope to protect the resistive film.

For inserting Balcohm resistors into standard circuits radial or axial leads are provided. Pin type and cap terminals may also be used for hermetic sealing and for mounting into jacks or fuse clips. For printed circuit applications we have developed a lead-less resistor whose ends are prepared for direct soldering to printed wiring.

Thermal Stability and Power Rating

For the purpose of comparing the thermal stability of Balcohm resistors with high quality commercial composition resistors, it may be useful to recall that the JAN-R-11 specification covering the latter provides for (a) full power rating at ambient temperatures up to only 40° C; (b) continuous derating as the ambient temperature increases, so that at 85° C (185° F), the power rating is 1/4 that of the full rating; and (c) a resistor body temperature limit of 135° C (275° F). In addition, the high temperature (85° C) load-life test for JAN-R-11 composition resistors permits a 10 percent change after 200 hours of intermittent operation under derated load.

In the light of these specifications it is interesting to compare the behavior of two groups of Balcohm resistors tested under much more extreme conditions by the Signal Corps engineering laboratories. These groups comprised six 100,000-ohm tubular units and six 2,000-ohm tubular units, whose size was about 1/2 of the Jan-R-11¹/₂ watt unit. These resistors were run at 1/2 watt intermittent load at an ambient temperature of 150° C (302° F). After 200 hours of operation under these conditions the average change of the 100,000-ohm units was less than ±2 percent (2.6 percent maximum change), and the average change of the 2,000-ohm units was ±0.3 percent (0.6 percent maximum change).

We have made some attempt to establish power rating and operating temperature specifications for these resistors, but results such as the following make this difficult. A resistor of JAN-R-11 one watt dimensions was tested under load at a series of ambient temperatures ranging from 20° to 200° C (68° to 392° F) with power dissipation ranging from 0 to 12 watts. The resistor was held for 1 hour at each temperature level at a given power, then the temperature was increased to a new level and the resistor operated again for one hour at the same power. After a run at the highest ambient temperature (200° C), the cycle was repeated with the power rating increased in steps of 1 watt, until a final test was run at 12 watts. Thus the final test at 12 watts was on a 1 watt size resistor which had had 1 hour each of operation at power levels of 0, 1, 2, 3, 4, 5, 6, 7, 8, 9, 10, 11, and 12 watts at 20°, 100°, 150°, and 200° C. The resistance at the start of this test was 194 ohms, and at the end of the test it was 182 ohms, a change of 6 percent.

Because of their extraordinary stability at high ambient temperature and high surface temperature of operation, it is not yet possible to assign definite power ratings to the various sizes and styles of Balcohm resistors, since present standards never contemplated either such thermal characteristics or the miniature dimensions now achievable.

The temperature coefficient of resistance of Balcohm resistors is approximately 0.1 percent per ° C (0.05 per cent per ° F) from room temperature to at least 200° C (392° F).

Direct Solderability

One of the potentially important applications of Balcohm resistors to the printed circuit field depends on the fact that these resistors may be furnished with metallized or tinned terminals which are integral with the body of the resistors and which may be heated to ordinary soldering temperatures without deterioration of the resistor. When wire leads are soldered to these terminals, or when the resistor body terminals are soldered directly to a printed or stamped metal conductor, the resistance change is less than 1 to 2 percent and thus negligible in the majority of circuit applications. The insulated tube or strip resistors may also serve directly as "cross-over" elements in printed circuit wiring.

This makes it possible for the equipment manufacturer to print conductors according to his wiring diagram, which is a simple matter, and then to solder resistors selected from his stock shelves directly into place without being concerned about "printing" his resistors. It is our opinion that this general method of approach will overcome the most serious obstacle

to the widespread adoption of printed circuit designs and techniques, since the manufacturer may purchase his "printed resistors," rather than be required to fabricate them. He will then be able to concentrate in his own field, that of design, assembly, and sales.

Balcoil Inductors

The problem of manufacturing highly stable inductors is a perennial one which has become more acute with the trend toward higher frequency ranges. Most inductors are unstable not only with respect to temperature variation but they also age badly, that is they vary with time even under ordinary conditions of operation. These secular fluctuations result from the dimensional instability of ordinary coil form materials. The mechanical stresses set up by differences between the thermal properties of the wire and coil form also cause the wire on wound solenoids to shift slightly. Furthermore in many cases the dimensional changes induced by temperature variation may never be wholly restored or may show considerable lag.

The application of the printed wiring principle offers the possibility of completely eliminating secular changes and significantly increasing the thermal stability of inductors provided that the coil form is properly selected. Fused quartz has the lowest coefficient of thermal expansion of any known substance and probably the lowest thermal hysteresis. Thus, the dimensions of a fused quartz form are not only changed very little by temperature variation, but they also revert very closely and quickly to original dimensions at any particular temperature. But in order to take full advantage of fused quartz as a coil form material, it is necessary to wind a metallic conductor in such a way that the dimensions of the winding are strictly determined by the coil form at all operating temperatures. By the use of previously described printed wiring techniques and others which we have developed, we have been able to construct inductors of this description in the form of solenoids and spirals (fig. 16.2). These methods present advantages in that they make certain types of novel designs possible. For example, the inductors may be terminated in standard sized pins to fit into sockets or pin jacks or they may be soldered directly into a circuit. They may also be hermetically sealed and shielded in a variety of ways. High silica and electrical glasses and ceramics may be also used as form material.

A design with interesting possibilities is an internally wound solenoid; i.e., one in which the conductor is firmly bonded to the interior surface of the cylindrical form rather than the exterior. Hermetically sealed leads may then

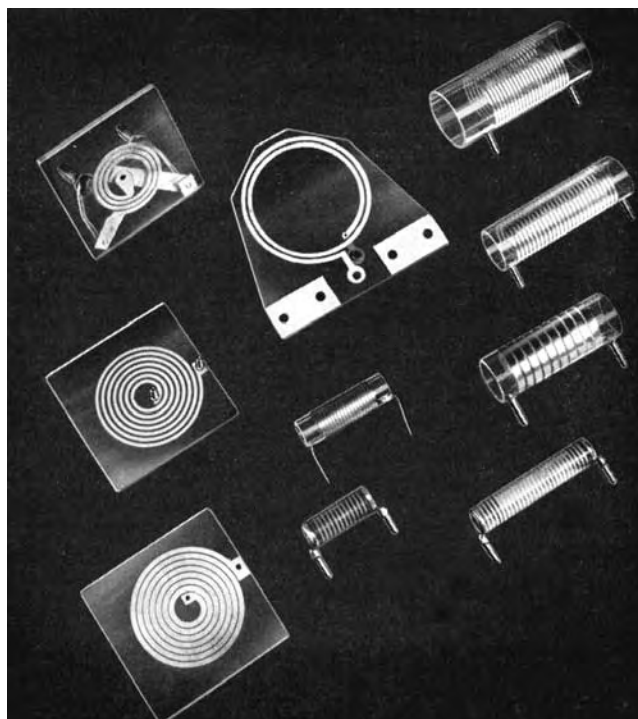

FIGURE 16.2. Flat spiral and solenoid printed inductors on fused quartz and glass forms.

The two bottom solenoids are printed on the interior surface of the coil form and the units are then hermetically sealed.

be provided at both ends of the coil or both leads may be brought to one end and the whole form sealed off. Evacuation or filling with dry air or hydrogen may precede the sealing-off operation.

Q Values

The Q of inductors of this general description depends in the first instance on structural and design factors common to all inductors whether wire wound or metallized. Among these factors are the dielectric properties of the coil form, wire size, turn-width and turn-spacing ratios, geometric shape, the ratio of such dimensions as length and diameter, etc. In addition to these factors, the Q of metallized inductors depends to a large extent on the nature of the metallizing process used. Thus, while the size of the conductor is one factor which determines Q in ordinary coils, two inductors of the same design and the same conductor metal and thickness prepared by metal-

TABLE 16.1.—Q values of balcoil inductors

Inductor	L uh	f mc/sec	Q
Flat spiral-----	0.7	35	200
Solenoid -----	.8	20	150
Flat spiral-----	1.3	20	150
Flat spiral-----	1.4	25	125
Solenoid -----	6.5	10	135

Balcap Capacitors

lizing in different ways may have very different Q values, because of differences in quality of the metal film. The Q values of Balcoil inductors may be as low as desired, and where necessary may go up to 200, design permitting. Typical values are shown in table 16.1.

Thermal Stability

The problem of specifying the stability of inductors as a function of temperature is complicated by the presence of other factors that enter into the measurement of inductance, such as the distributed capacitance and resistance of the coil. We have preferred to proceed by recognizing that the great majority of applications for highly stable inductors involve their use in frequency determining circuits such as oscillator tank coils or tuning coils. Therefore we have attempted to determine the thermal stability of an inductor by making it the frequency determining element in an otherwise highly stable oscillator and then measuring the shift in frequency of the oscillator as the temperature of the test coil alone is varied. Our oscillator uses the transitron circuit originally described by Brunetti²⁷, modified for stable operation up to 20 Mc. The test coil is thermally isolated from the oscillator. In the temperature range from 25° C to 150° C, preliminary measurements indicate inductor stabilities (expressed in terms of frequency shift) of 5 to 20 parts per million per ° C (3 to 11 ppm/° F).

Fabrication Tolerance

In connection with the high performance quality inherent in inductors of this type, it is of interest to note that they can also be fabricated with considerable precision with respect to both physical dimensions and inductance values. If necessary, physical dimensions including mounting hole or terminal spacings may be held within a few thousandths of an inch. Inductance values may be regularly held within a tolerance of ± 2 percent, and ± 1 percent or less is achievable.

Thermal Shock Behavior

Despite frequently voiced doubts as to the thermal shock resistance of metallized coils because of the disparity in expansion coefficients of the form and the metallized conductor, Balcoil inductors are highly resistant to thermal shock. In many cases we have found it possible to eliminate coil form fracture or winding separation in thermal shock tests run from -75° to 300° C (-103° to 572° F) and from 300° to -75° C. The inductors also possess highly satisfactory mechanical ruggedness, especially when compared with wire wound components.

²⁷ Brunetti, The Transitron Oscillator, Proc. IRE 27, 88 (1939).

The possibility of fabricating miniature capacitors of high dielectric materials such as titania and the titanates has been recognized for some time and such units are commercially available. However, the inability to produce thin films of good quality by standard ceramic techniques has made it impossible to fully exploit the potential value of materials with high dielectric constants. The capacitance of a parallel plate capacitor is $C = KA/t$, where C is capacity, K is dielectric constant, A is the electrode area and t is thickness of the dielectric. For a given area, C is a function of K/t . In the case of oiled paper films used in capacitors, the dielectric constant is, say, about 5 and the thickness about 0.001 in., and therefore K/t is about 5,000. In order that a ceramic film with a dielectric constant of 100 should occupy an area equivalent to that of 0.001 in. oiled paper, its thickness must be 0.020 in. To secure any real advantage, its thickness must be much less. Conversely, for a thickness of 0.030 in., which is frequently the practical lower limit with ordinary ceramic fabrication methods, the material must have a dielectric constant considerably in excess of 150 in order to obtain a decided advantage over oiled paper.

To overcome this handicap and to secure space advantages, ceramics with very high dielectric constants have been developed. However, these have been found to be useless for many purposes both because of their erratic behavior and because of their ferroelectric properties which result in excessively large changes in dielectric constant as the ambient temperature is varied.

Materials and techniques of fabrication which promise to overcome these difficulties are in process of development in our laboratory. Capacitors have been produced with dielectric films varying in thickness from 0.001 in. to 0.010 in. and with a dielectric constant of about 90. The power factors may be between 0.0002 and 0.001, that is, capacitor Q 's are between 1,000 and 5,000. The temperature coefficient of capacity is about 0.05 percent per ° C and is uniform between room temperature and 300° C.

While the thinnest films have so far been produced only on an experimental basis, films as thin as 0.005 in. are believed to be already practicable from a production standpoint. Dielectric films of this thickness are easily handled and may be stacked and fabricated into condensers by simple techniques.

Dielectric Constant and Power Factor

Some preliminary investigations have been made on the variation of dielectric constant

and power factor of Balcap films with temperature. These measurements have been carried up to 300° C for dielectric constant and up to 250° C for dielectric loss. As may be imagined, precise measurements at such temperatures involved several difficult problems. Since the methods by which these difficulties may be overcome may be of considerable interest, full details will be subsequently published. It should be noted parenthetically, however, that the solution of these problems was considerably facilitated by the use of printed circuit wiring techniques, and the extension of such techniques to the construction of special units such as co-

axial lines. The temperature coefficient of dielectric constant (fig. 16.3) is about 0.05 percent per °C (0.03 percent per °F) and is approximately uniform up to at least 300° C as shown by table 16.2. The power factor data in table 16.2 demonstrates that low losses are maintained at least up to 250° C. (These power factor data include losses in the measuring line; only a few of the measured values are shown in the table).

Breakdown Voltage

Ceramic dielectrics of very thin cross section have generally been considered to be impractical not only because of the difficulty of fabrication, but also because of their dielectric strength is low and erratic. The presence of voids, pinholes, or microscopic impurities (which are covered in thick sections) produce regions of high dielectric stress in thin sections which are fatal to capacitor quality. Films prepared by our methods appear relatively free from this defect, and excellent breakdown strengths are maintained up to very high temperatures. Thus a series of measurements were made on 27 different samples approximately 0.006 in. thick at temperatures ranging from

TABLE 16.2. — *Temperature variation of dielectric constant and power factor*

Temperature	K	PF
° C		
40	89.0	0.001
80	87.5	.0007
120	85.6	.0008
160	83.7	.0008
200	81.5	.0006
250	79.7	.0009
280	78.85	
300	78.0	

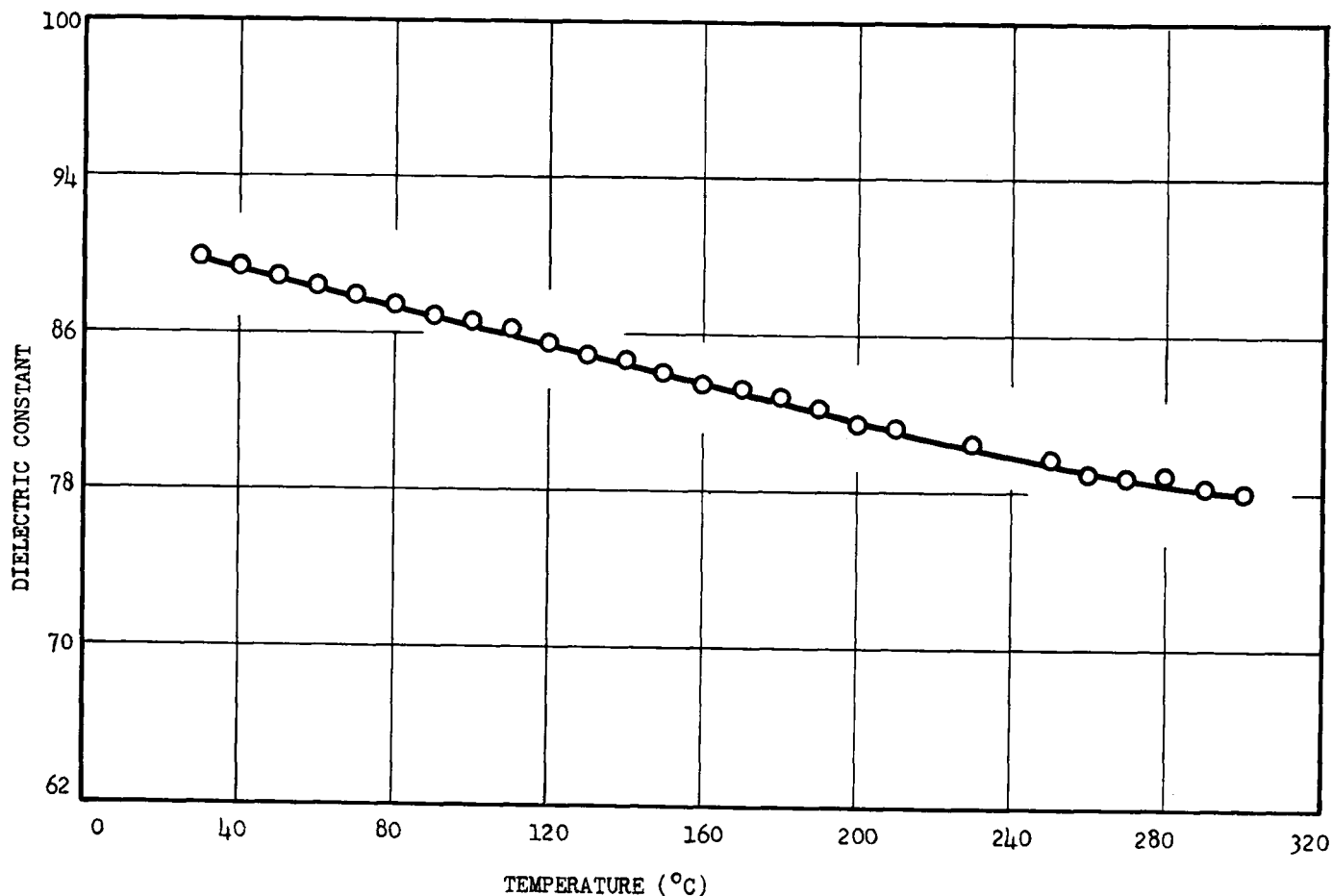

FIGURE 16.3. *Variation of dielectric constant with temperature of Balco dielectric films.*

room temperature up to 520° C (968° F). The break-down voltage in all cases was greater than 1,300 volts and this value or better is maintained even at the highest temperatures, almost a dull red heat, as shown in table 16.3.

While previously proposed methods of application of printed circuit techniques appear to result in freezing design and reducing the opportunity for individuality on the part of the equipment manufacturer, the components described here will permit retaining the advantages of flexible design and circuit modifications which are desirable features of classical assembly techniques. This is made possible by the high temperature stability of our components which permit one to eliminate leads and solder the components directly into the circuit wiring.

Assembly-line processes based on these considerations may be conceived as follows. A moving belt has placed upon it at the first station, the base plate for the printed circuit wiring. Prewired die-stamped or metal-sprayed circuit plates may be used. Alternatively, the wiring may be printed while on the belt, and then heat-treated in a conveyor furnace if metallizing paints are employed.

TABLE 16.3. — Breakdown voltage for Balcap condensers as a function of temperature

(Average thickness=0.006 in.; 27 samples)

Temperature	Breakdown voltage (d.c. volts)
° C	
20	1,340
110	1,840
200	1,560
300	1,650
400	1,820
450	1,570
473	1,740
520	1,780

Electrodes

When working with dielectric films possessing such high dielectric constants and low power factors, the method of electrode application is of great importance if the qualities of the resulting capacitor are not to be degraded below those which are inherent in the dielectric film itself. Satisfactory electrodes may be applied by firing on silver paints, vacuum evaporation, vacuum sputtering, or any of the other standard methods for working with mica dielectrics. Techniques have also been developed for stacking such films so that structures analogous to mica condensers result.

Thermal Shock Behavior

The thermal and mechanical shock resistance of these film capacitors is very good. Soldering

irons can be used on pretinned electrodes without fear of shattering the film. We have even found it possible in some cases to fasten leads to these film capacitors by spot welding techniques. These features obviously will permit the direct soldering of these components into printed circuit wiring.

Assembly Line Techniques

It has been evident that much of the interest of equipment manufacturers in printed circuit techniques has been in the opportunities which they provide for production simplification and assembly cost reduction, factors which are at least as important as compactness. We wish to point out that the prefabricated components described above make it possible to utilize these opportunities to a very large extent, without introducing the problems of fabricating components such as resistors on the assembly line.

The prefabricated resistors, the capacitors, and where applicable, the inductors are supplied to the equipment manufacturer with terminals already tinned, and are stored in individual hoppers mounted over the belt. At the second station, either the entire set of components is dropped onto the wired plate, or if too complex an arrangement is required, this placement may be done in several steps. Correct, automatic positioning may be obtained by providing pregrooved and recessed plates, or indented strips in the case of die-cut wiring, so that the components do not shift. Another simple method of positioning is to provide a thin stencil jig held in position over the plate, with openings cut to receive the components and retain them in their correct place relative to the wiring. The unit with components in position is then passed under one or more heated platens which are then brought down on the circuit plate. The components are thus soldered to the circuit wiring without the use of highly skilled solderers. Another soldering method that is extremely effective in our experience is induction soldering. By the use of a high frequency induction furnace we have found it possible to solder our components directly to either ordinary or printed circuit wiring at high speed.

Tubes and other components which do not lend themselves to assembly by hopper feed may then be inserted in the ordinary way, and the circuit assembly thus completed.

An additional advance that promises to be significant is based on our finding that it is possible to metallize and firmly bond conductors to a ceramic or glass plate without treating the whole plate in a high temperature furnace. This has been achieved by induction heating and other electrical methods. The treatment

cycles are very rapid because the most massive part of the unit, the insulating base plate, is not heated very much. The components may also be soldered at the same time, and indeed because of the cementing action of metallizing paints it may eventually prove to eliminate much of the soldering. Considerations of this nature, however, soon move into realms where assembly speeds become absolutely fantastic, at least on paper.

Meanwhile, it is to be hoped that the availability of the prefabricated, highly stable components and the simpler assembly techniques described above will be of help to equipment

manufacturers in more fully utilizing the miniaturization, production simplification, and assembly cost reduction made possible by printed circuit wiring.

Acknowledgment

In the fabrication and test of the components described above we wish to acknowledge the help of our laboratory staff including J. A. Brady, D. Buskin, A. Hershler, M. Pope, S. A. Thompson, A. U. Koppel, A. Weinstein, under the supervision of S. Eisenberger.

Further thanks are due to the United States Signal Corps which aided this work financially.

17. Typical Commercial Applications

Two Stage Printed Circuit Amplifiers²⁸

A brief description of a printed two-stage amplifier with a filter circuit, which incorporates several variations from the type of printed circuits previously discussed, is of interest. This amplifier was tooled for use in the Citizens Communication band transceiver under development by the Citizens Radio Corp. of Cleveland. One of the engineering models of this amplifier measures $2\frac{3}{4}$ in. long, 2 in. wide, and with the tubes approximately $\frac{3}{4}$ in. thick. The amplifier has eight capacitors and nine resistors.

One of the variations on our amplifier is the use of tubular ceramic capacitors rather than the flat variety. These tubular capacitors may be laid on the surface of the printed ceramic base and soldered directly to the silver conductors. Another variation would be to place these capacitors in slots in the ceramic base so that the entire surface of the base will be flush.

Due to the difficulties sometimes encountered in mounting tubes and affixing terminal lead wires to the ceramic base, we have developed another variation from standard printed circuit techniques. This method consists of countersinking the hole to which the lead will be soldered, from both sides of the base. By silvering the entire surface of the countersunk hole and by placing a drop of solder on either side of this hole, a rivet of solder is formed on the lead which is strong, durable, and highly resistant to vibration. A production model of the amplifier (fig. 17.1), illustrates two of these variations from standard procedure.

Printed Circuits in Transmitters and Receivers²⁹

Printed circuit techniques are here to stay, for they are a boon to the radio and electronic industry. From our experience in applying printed and associated components to transmitters and receivers, the economy and compactness of these circuits is without parallel.

Wiring by printed circuit techniques, reduces cost and bulk of wiring, simplifies design and lends itself to rugged compact construction. Inventory is reduced and the need for testing of individual components is eliminated. This simplification of subassembly and assembly opera-

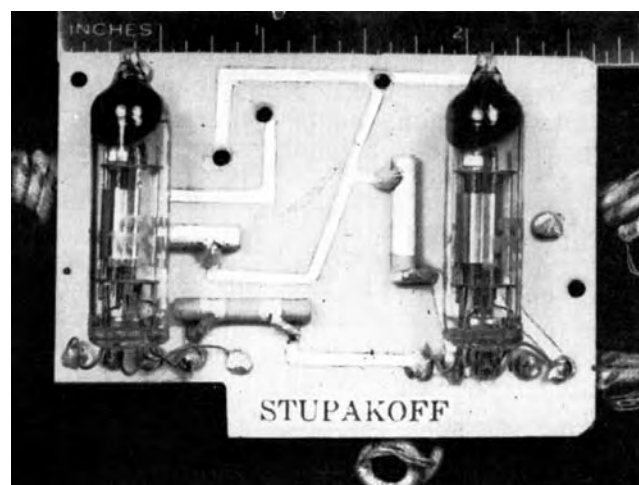

FIGURE 17.1. *Production model of two-stage printed circuit amplifier.*

Nine printed resistors are on the reverse side of the plate.

²⁸ By G. G. Hornung, Stupakoff Ceramic & Mfg. Co., Latrobe, Pa.

²⁹ By Al Gross, president, Citizens Radio Corp., Cleveland, Ohio.

tion, reduces cost of labor and overhead and affords a tremendous increase in production.

In the standard methods of wiring, terminal boards and mountings are required in various parts of the chassis, whereas, in the printed circuit techniques the insulation serves as terminal board, socket mount, and chassis and sometimes as a dielectric medium for built in capacitors.

Our adaptations of printed circuits are applied both to audio and radio frequency circuits. In our transceiver audio circuits, the application of a printed circuit eliminates 26 separate components and the inspection, forming, cutting, and other preparatory operations.

In applying a printed circuit to radio frequency applications great care must be exercised in the design and layout of the circuit particularly when dealing with very short wave lengths. At these wave lengths, the dielectric used to support the printed design which carries radio frequency currents becomes a deciding factor in the efficiency and operation of the over-all circuit. The presently known dielectrics such as ceramics, quartz, glass, certain phenolics and plastics, are excellent mediums for supporting these very high frequency circuits. In our transceiver, the radio frequency circuit and several associated components are supported by a ceramic plate. This circuit should be supported by a quartz plate. The rigidity that is offered by this arrangement tremendously increases the frequency stability and makes it difficult to tamper with the circuit elements. It also reduces the possibility of circuit misalignment. In our transceiver, the use of this plate increases the speed with which the radio frequency unit is assembled. It also eliminates three components, one which requires brazing to the chassis, and another which is a wire configuration that is die formed. Once the circuit is adjusted and in place, it will withstand a certain amount of rough handling. This means that the equipment using printed circuits and components will be much more rugged than conventional design. Testing becomes a simple procedure since there is so little to adjust.

Since our transceivers will be used in various parts of the country, the use of printed circuits and components greatly increase resistance to temperature and humidity effects. Enhancing this property still more, a complete printed layout can be made practically impervious to temperature and humidity by coating the entire unit with plastic protective material. It may be desirable to cast the entire unit in a styrene or plastic resin to minimize the effect of mechanical shock. Once cast, the unit is also impervious to submersion in water.

The development of printed circuits is not

new; as a matter of fact, the application of metallic coating to ceramic dates back to the days of the early Roman Empire, when pottery and other objects of art were trimmed and covered with silver and gold foils. It was later discovered that by firing the object of art, the foil would fuse with the ceramic or pottery and form a permanent bond.

Our "Ultraphone" transceiver incorporates printed circuits and the associated refinements making it an effective and practical two-way Personal Citizen's Radio transmitter and receiver.

First Application of the Printed Circuit Technique To A Hearing Aid³⁰

Late in 1946 the Allen-Howe Electronics Corp. of Peabody, Mass., began to consider the possibilities of applying the printed-circuit technique to a hearing aid.

It was felt that there were certain technical limitations still to be mastered before it would be possible to produce a quiet efficient hearing aid circuit. Investigation of available data on the printed-circuit technique indicated, however, that the application was feasible and the first circuit designs were attempted by the Allen-Howe Electronics Corp. in cooperation with Centralab, division of Globe-Union, Inc., in June 1947.

Variations in circuit and layout designs were reduced to four types on two basic circuits. After complete testing and further investigation a circuit (fig. 17.2A) with suitable gain-frequency characteristics was decided upon as the basic circuit for the production model (fig. 17.2B).

In designing the hearing aid it was found possible to incorporate the steatite plate as a structural part of the chassis unit, a factor which makes for extreme simplicity in assembly. The chassis consists of only four basic units. These include the steatite printed-circuit panel, the transformer panel, the control panel and the battery panel. All of these units are held together by four bolts located at each corner of the printed circuit panel.

A great deal of study was necessary to make possible the proper lay-out of controls and output plug, since hearing aid design requires that volume and tone controls, as well as the output cord connections, be placed at the top of the instrument so that they are easily accessible when in the pocket. In spite of the high-gain circuit required, severe feedback problems were finally mastered.

³⁰ By Leon Strauss, Jr., president, and Verche Strauss, vice president, Allen-Howe Electronics Corp., Peabody, Mass.

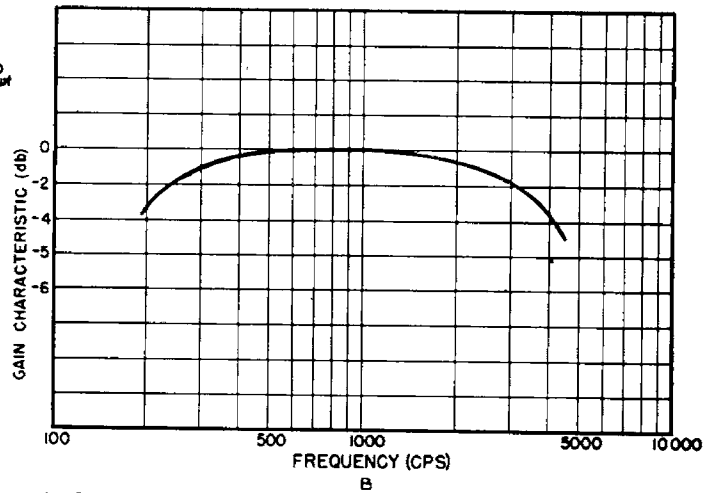
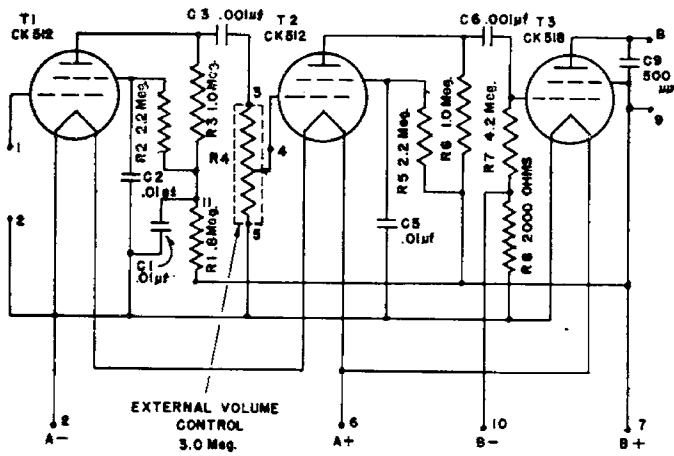

FIGURE 17.2.

A. Schematic diagram of the printed circuit amplifier used in the "Solo-Pak" hearing aid. B. Gain-frequency characteristic of the "Solo-Pak" hearing aid.

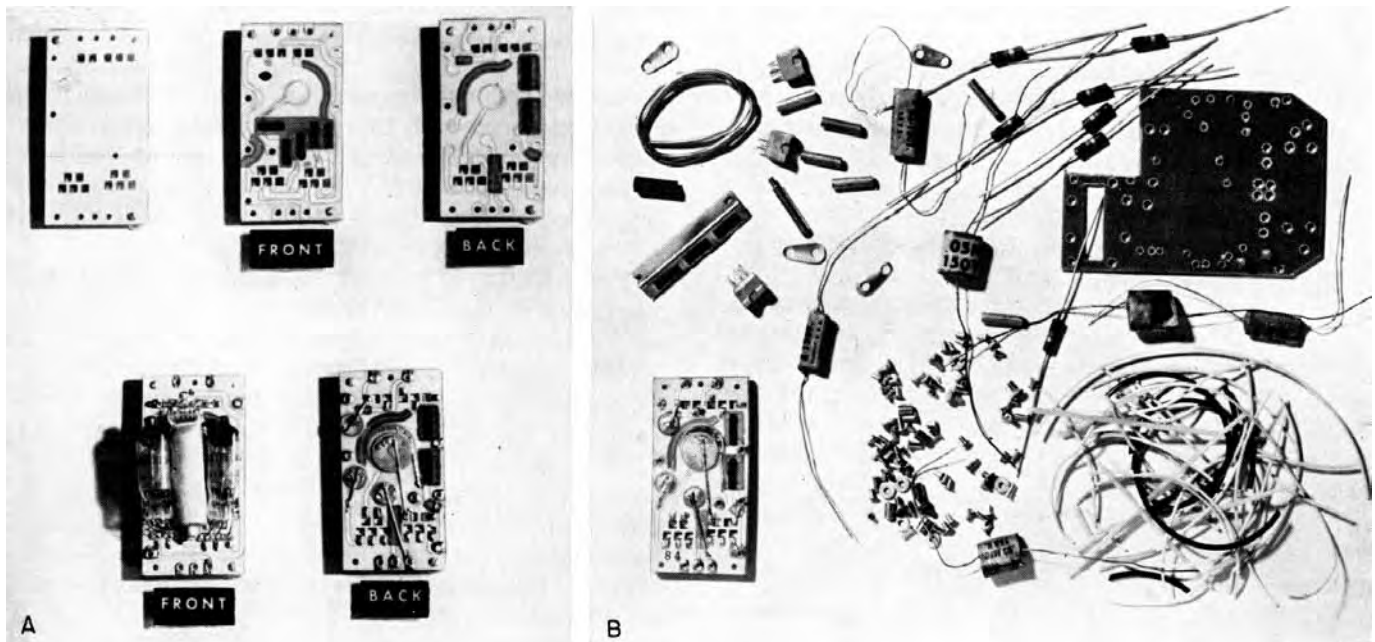

FIGURE 17.3.

A. Front and back views of the printed circuit amplifier shown in varying stages of completion. B. Printed circuit amplifier in lower left hand corner as compared with the 173 items used in making up a conventional amplifier of similar electrical design.

The printed circuit in various stages of completion (fig. 17.3A) beginning with the blank steatite plate and ending with the completed unit shows the arrangement of components and the manufacturing steps involved. A more obvious advantage of the printed circuit technique is the replacement of the 173 items used in a conventional amplifier of similar electrical design by a single printed circuit plate (fig. 17.3B).

Tests have shown this amplifier to have superior power-gain characteristics over the best of the conventional hearing aid circuits. With 1 millivolt input, the circuit delivers an output of 1.3 volts. With the same input, the best of 15 conventional hearing aid amplifiers tested

delivered not more than 1 volt output. This advantage is understandable because the maze of components wired together and crammed in a small space in the ordinary hearing aid introduces "coupling" between output and input that has a degenerating effect. Conversely, the clean arrangement of printed wiring and the scientific placement of capacitors, resistors, and other components made possible by the printed circuit technique reduces "coupling" to the absolute minimum.

The degree of miniaturization attained through the printed circuit technique has made it possible to use some of the space saved in furnishing greater battery life. The instrument utilizes the Mallory RMB-4 Mercury 'A'

cell which provides over 80 hours of operational life as compared to 25 hours available in the conventional hearing aid.

The 'B' battery utilized is the Eveready 22½-volt, type 412E Minimax. This battery furnishes approximately 300 hours of life.

With the advent of small batteries developed during the war the entire hearing aid industry has followed a trend toward miniaturization through combining into one unit the battery pack and amplifier unit. This trend has necessitated the use of increasingly smaller microphones which are particularly insensitive to low frequencies and tend to peak up at the high frequencies. This factor usually decreases the quality of reproduction obtainable in current one-piece hearing aids. The additional gain obtainable through use of the printed circuit technique over standard methods has made it possible in the Allen-Howe SOLO-PAK to electrically compensate for the microphone deficiencies and still obtain an output that is greater than can be obtained in the average instrument. This particular advantage was found to be an unlooked for dividend in the production of the hearing aid using a printed circuit.

One of the greatest difficulties encountered in the use of the conventional hearing aid has been the constant necessity for repairs in the field. These repairs are caused primarily by physical weakness of tiny solder connections, physical and electrical weakness of small paper condensers and damage caused by humidity. With the advent of the printed circuit in a hearing aid all of these factors have been reduced to a negligible quantity. The degree of miniaturization obtained through this new technique has made possible, in addition to better tonal qualities and greater power, the inclusion of additionally long life batteries for more economical operation in a unit only slightly larger than a package of cigarettes, believed to be the smallest hearing aid available.

The case is formed with removable back section from pure aluminum sheet type 2S—½ hard. It is finished with a high polish and

anodized to give it a hard, smooth aluminum oxide coating which does not scratch or mar easily and reduces acoustic case noise to a minimum.

It is believed particularly significant that the hearing aid was the first such "consumer product" application of the printed circuit technique developed by the Bureau of Standards because it dramatically demonstrates how extremely practical and efficient this technique can be even on such an item of relatively low quantity production as a hearing aid. It has been conclusively proven to us that this technique is far superior to older methods from the point of view of performance, cost, ease of production, product dependability and miniaturization.

Mycalex 410 Base Plates for Printed Circuits³¹

Mycalex 410 is a molded glass bonded mica material having extremely low loss characteristics in the high frequency range as well as other desirable electrical properties. It is an approved ceramic of grade L-4 under Joint Army-Navy Specification JAN-I-10.

Potentially, Mycalex 410 offers many advantages in the printed circuit field. Outstanding is the fact that since it can be molded, intricate shapes are entirely feasible at low cost. The coefficient of thermal expansion is in the range of metals and very closely matches that of soft steel. Silver and other inserts for contact purposes can be molded directly into the material without fear that they will ever loosen in service. The combination of inserts molded into the base material with any desired contour of the part, adds a degree of flexibility to printed circuit design which may prove of great importance in this field as the art progresses.

In a simple form of Mycalex plate (fig. 17.4), it will be noted from the back view that the inserts may be used as contact prongs for a plug-in type of assembly. The use of these inserts can be extended to many other types of applications.

Printed Inductors³²

This paper describes a simple adjustable tuning element recently developed by General Ceramics & Steatite Corp. It is a stable inductor having an adjustable member which varies the distributed capacitance.

³¹ By Felix L. Yezley, director of research and engineering, Mycalex Corp. of America, Clifton, N. J.

³² By C. L. Snyder, vice president in charge of sales, General Ceramics & Steatite Corp., Keasbey, N. J.

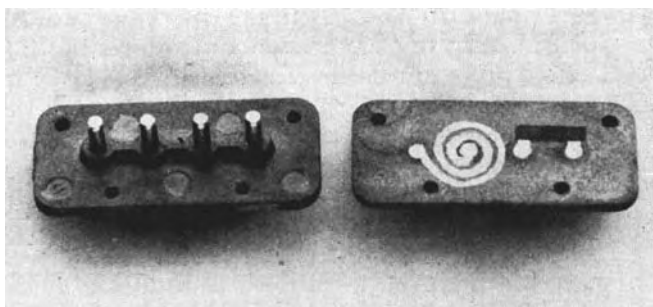

FIGURE 17.4. Printed plug-in unit on a molded Mycalex base plate.

The device consists of a pair of spiral inductors of silver deposited on spiral ridges pressed on both sides of a steatite plate. They are joined by a common connection through a hole in the plate at their centers. When viewed from one side their paths are opposite causing the magnetic fields to aid. A wafer made of material having a high dielectric constant is mounted on one side of the plate on a pivot (fig. 17.5). Deposited on a semicircular segment of the wafer on the side not bearing on the steatite is a group of singly connected conducting bands which make contact with the pivot. An exterior terminal of one of the spirals is also connected to the wafer pivot. In the sample the wafer conductor is connected to the terminal of the spiral on the wafer side of the steatite plate. A larger tuning range may be had by connecting the pivot to the other terminal of the inductor. Both the steatite plate and the wafer are ground flat over their mating surfaces.

When the wafer is turned so that its conductors are away from the spiral, the distributed capacitance is slightly greater than without the wafer. It is possible to omit the unsilvered half of the wafer or relieve it so that it does not bear on the inductor and remove the slight capacitance caused by its presence. When the conducting bands on the wafer are over the inductor, the distributed capacitance is greatly increased for two reasons: First, the bands appear to the electric field as a uniform plate because the high dielectric constant of the material on which they are deposited prevents the formation of appreciable gradients in the space between them. Second, the high dielectric also prevents much of a gradient through the wafer so that to the electric field of the spiral there will appear to be a conducting plate very close to the coil. The magnetic field will be little disturbed by the presence of the wafer conductors because no closed loops are formed. Therefore, the introduction of capacitance does not decrease inductance and a uniformly high Q is maintained.

Stable characteristics are, of course, obtained from the ceramic construction. In addition, economical large-scale production with close tolerances can be achieved because both ceramic pieces can be pressed on high-speed machines. The formation of the spirals during the pressing operation and a grinding operation after firing insure uniformity.

Herlec Bulplates³³

The Herlec type of printed circuits are units of two or more capacitors with printed con-

³³ By G. Milton Ehlers, Herlec Corp., Milwaukee, Wis.

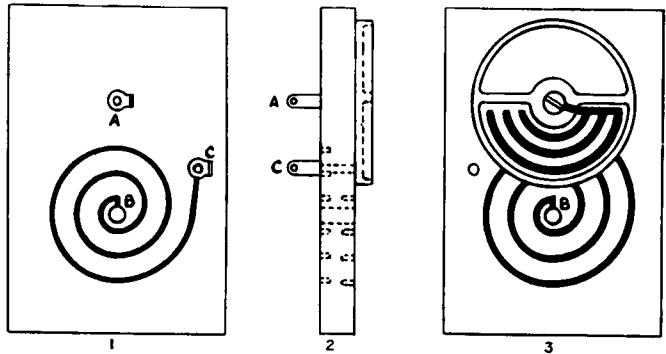
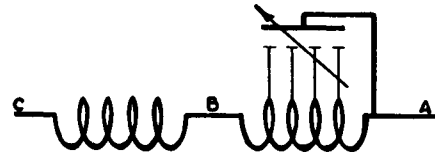

FIGURE 17.5. Drawing showing the construction of the adjustable resonance circuit.
(1) Back view; (2) side view; (3) front view.

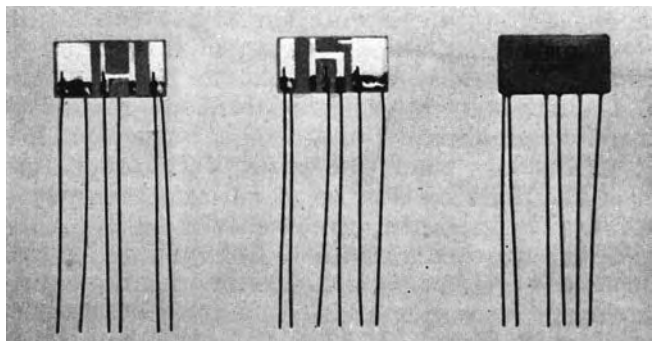

FIGURE 17.6. Herlec "Bulplates," showing construction. The unit at the right is coated with a thermosetting material.

nections with or without resistors, all of which are placed directly onto the ceramic dielectric plate. This means that the supporting ceramic plate for the printed circuits, resistors, and etc., also forms the dielectric of the printed capacitor and results in the fewest number of soldered connections. The only soldered connections are those of the wired leads for external connections. The Bulplates (fig. 17.6) with leads for external connections are usually covered with a coating of superstrong thermosetting material which adds strength to the units and acts as a positive anchorage for the leads throughout the handling and soldering operations when assembled into electronic circuits. This mechanically strengthening thermosetting coating also electrically insulates the Bulplates from any parts that they might touch and with a wax impregnation serves as an excellent protection against high humidity. The physical size and the dielectric constant of the Bulplates

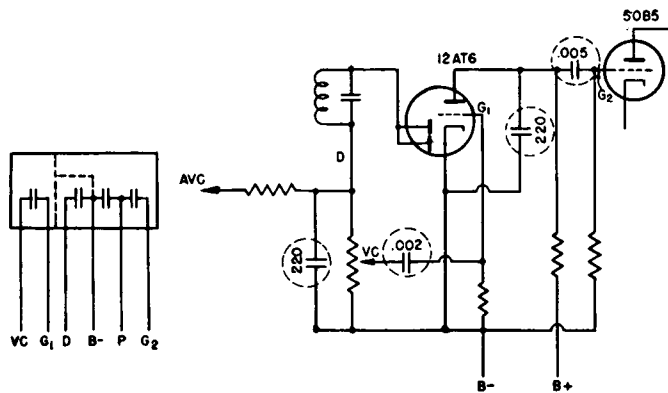

FIGURE 17.7. Schematic diagram showing the capacitors included in the "Bulplate" of figure 17.6.

are determined by the allotted space and the electrical capacitance requirements in each specific case. By the proper choice of the ceramic dielectric in the plates, Bulplates can be successfully used in both the audio and RF circuits.

Where space and cost are individually or collectively of major consideration, Herlec recommends a Bulplate circuit (fig. 17.7) consisting of capacitors, printed wiring, and leads only; omitting printed resistors. At the present state of the art body type of resistors are manufactured automatically in extremely large numbers at prices less than the value of the capacitor area required by a printed resistor. The savings are, therefore, greater with a Bulplate in which the space required for a printed resistor is converted into a capacitor and the space saving is also greater because most of the capacitors replaced by Bulplate ceramic capacitors are larger than the present day molded resistors.

Bulplate capacitors have all the well-recognized permanence and high quality of ceramic dielectric capacitors. In the Bulplate-type of circuit there are fewer solder connections in the circuits than in cases where the capacitors are soldered into position which reflects itself into a more trouble-free circuit and a definite saving in the assembly costs. Additional benefits are the savings in space and weight and the simplification of ordering and inventory and stock problems.

An example which is used to express the tangible savings in money, weight, and space includes four capacitors of the audio coupling networks (fig. 17.6) of a typical a-c/d-c table model circuit.

The following approximate figures picture a typical case of the tangible savings and benefits of the above Bulplate type of circuit versus the conventional type with standard component parts:

	Bulplates per M	Conventional per M	Savings per M
Weight	4.4 lbs.	30.4 lbs.	26.0 lbs.
Volume	31.0 cu. in.	388.0 cu. in.	357.0 cu. in.

With savings of two solder joints at $\frac{1}{2}\phi$ each the total savings is upwards of 15 percent to the set manufacturer.

The above figures are approximate because of varying labor rates and capacitor sizes and prices throughout the United States but can be considered balanced well enough to indicate that at the present state of the art of printed circuits definite savings in costs and space can be achieved with printed circuits by the proper choice of the component parts and sections of the circuit which are replaced with Bulplates.

18. General Discussion

Summary³⁴

It will be of value to sum a few facts from the papers presented here today. We may conclude that the conductors of an electronic circuit may readily be printed by any one of a large number of successful methods. Many of these methods, described in detail, have been proven in practice on production lines; others have just been started. A principal item requiring further attention to achieve over-all perfection in printing circuits is the development of improved methods of printing resistors

³⁴ Dr. Cleo Brunetti, National Bureau of Standards.

without the requirements of expert knowledge or experience.

Not all the components of an electronic circuit may be printed. The practice has been adapted principally to conductors, resistors, capacitors, inductors, shields and antennas as well as some miscellaneous electronic accessories. We have not printed a vacuum tube, but there are ideas for incorporating a vacuum tube within a flat ceramic sheet. We mentioned one of them in the paper "Printed Circuit Techniques," which I referred to this morning.

The paint stenciling and the spraying processes are the ones which have been used with

greatest success in making complete electronic circuits today. Most of the printed processes are adaptable to manufacture of practically all of the ordinary low power electronic devices. The printed circuit technique may be used at high as well as low frequencies.

The problem of tolerances can no doubt be overcome. As soon as such a problem is turned over to industry, American ingenuity finds the answer. Close tolerances have been obtained in high production as some of the men showed you today.

A properly designed printed circuit offers size reduction comparable to the best of standard miniature electronics practice and in certain cases affords a degree of miniaturization unobtainable by other means. The subminiature transmitters and the amplifiers in which the circuit is painted on the tube envelope are examples of miniaturization unattainable by other means. Other examples are the tiny commercial filter and interstage units printed on high dielectric base plates which are now on the market and were described earlier. A pi filter made in this way, consisting of two capacitors and a resistor, has a total volume of less than six-thousandths of a cubic inch. A complex audio coupling circuit occupies a volume of less than three-hundredths of a cubic inch. These are items which are on the commercial market and hence the production problems have been overcome.

Just how much space saving may be realized depends on the application. Standard electronic components are now available in such miniature size that complete amplifiers may be built into volumes of less than one cubic inch using standard methods. In the printed electronic circuit, most of the volume is occupied by the base material. By providing thinner base materials or better yet by applying the wiring to an insulated outer or inner surface already present in the assembly such as the tubes themselves or part of a plastic cabinet, an additional reduction in volume occupied by the wiring may be had. Someone has suggested that radio manufacturers simply print the circuit on the inside of the cabinet and use the cabinet for storing magazines.

While definite advantages are realized when printed circuits are produced in large quantities, it is also possible to use some of the techniques, such as the painting process, for making a few tailored sets. The advent in the market of a new printed hearing aid proved that printed circuits are feasible in moderate quantity production.

A manufacturer does not need to equip his plant to produce sets that are printed in every electrical detail to take advantage of printed circuits. Some have introduced the process of

printing only a subassembly or an interstage network of a complex set. Others have printed only the conductors, and have used standard resistors and capacitors for the remainder of the circuit.

The radio I showed you in a slide this morning, being engineered by a Florida concern, incorporates the standard interstage coupling networks available on the market today and illustrates one method of introducing printed circuits. The interstage coupling units cost less than the standard components plus the cost of wiring and of handling components.

None of the sponsors of the symposium are in the printed circuit business. We are trying to help you evaluate both the advantages and disadvantages of printed circuits. That is why production quantities and prices, ordinarily not treated in a symposium of this kind, have been mentioned.

Another measure of what is possible has been provided by the development in England of a completely automatic apparatus for wiring panels. It is a spraying-milling technique designed for the automatic manufacture of small a-c/d-c radios. A plastic plate is used with molded indentations for conductors, inductors, capacitors and mountings for other components. The plate is fed into an automatic machine which sand-blasts both sides, sprays the surfaces with zinc, mills the surfaces to remove the surplus metal, tests the resulting circuit, sprays on graphite resistors through stencils, inserts tube sockets and miscellaneous small hardware, tests the unit again and applies a protective coating over the panel, all at the rate of 20 seconds per panel. Each operation is controlled separately by electronic circuits and operates only on the arrival of a panel. Should two successive panels be rejected at any point on the line, all previous operations are stopped until a personal inspection is made. All panels beyond that point are continued on to completion. In a single radio set the need for hand assembly of 30 components was eliminated and 80 hand-soldered connections were said to be avoided.

Experienced judgment leads to the conclusion that the new techniques are practical; that they promise size reduction comparable to the best of standard miniature electronics practice and in certain cases, afford a degree of miniaturization unobtainable by other means. Conventional production methods cannot easily compete with printed circuits from the standpoint of uniformity and minimum required inspection since each of the latter units is a duplication of a master pattern.

Manufacturers evaluating the advantages of printed circuits often compare them with present production costs based on years of engi-

neering design and production experience. The initial printed assemblies which have come on the market have in general been found to cost no more, and in most cases less, than present costs of conventional methods of production. Remembering the pattern new developments usually follow, one can reasonably expect that if the costs of the new techniques today do not exceed those attained by years of practice with the conventional methods, it should not be long before printed techniques will reflect considerable savings in both engineering and production. When the initial production difficulties are inevitably mastered, printed circuits should provide substantial reduction of assembly, inspection, purchasing and stocking costs and problems.

Patents

Before concluding, I would like to say a final word regarding the patent situation, although not too much can be said in explicit terms. Many of the techniques are adaptations of processes patented long ago and on which patents may have expired. Much of the technical information is classed as standard knowledge of the art and is unpatentable. However, certain patents have been applied for by industrial organizations and also by the Government. Because of the large backlog of work in the Patent Office, it is not expected that final decisions on these applications will be reached early. It is believed that most of the patents in process relate principally to specific processes and applications. Patents applied for by the Government may ultimately be made available to industry on a nonexclusive basis without charge. However, concerns planning to use printed circuits commercially are advised to check the patent situation in the same manner as would be employed in adapting any manufacturing process.

Questions and Answers

Question:

In regard to the British method Dr. Brunetti mentioned in his summary on printed circuits, I have a question and would also like to inform the audience that the subject was written up quite thoroughly in the January-February 1947 issue of the British Institute of Radio Engineers (vol. 7, No. 1). Among other things in their article was mentioned the ability to produce metal film resistors on these chassis plates that can dissipate as much as 10 or 20 watts. Have we been able to get anywhere near that?

Answer:

Yes, resistors printed on steatite have been manufactured in this country, with a dissipa-

tion of about 25 watts per sq in. We tried but unfortunately were not able to get one of the Sargrove chassis here in time for this meeting. They appear to have a workable process which would merit looking into since the machine is completely automatic and 20 seconds per panel is a very short time for assembling. The paper would be worthwhile reading since it contains many good ideas on how to produce printed elements of a set. Has anyone in the audience seen one of the completed receivers made by this process?—Dr. Brunetti.

I have just returned from a trip to England where I visited E. K. Cole who does a great deal of Bakelite molding in that country. They are molding the plates used in the Sargrove process and told me they were running into some difficulties, although these were not insurmountable. As the article indicates, the capacitors are very thin sections of the Bakelite molding. In the process of molding the plate it is difficult to maintain the tolerances required for the set. The other difficulty is the danger of the Bakelite cracking at that point. I have not seen the completed receiver.—Mr. D. I. Cooper. (EDITOR'S NOTE—Samples of this receiver may be seen by addressing Lord Pentland, Director, American British Technology, Inc., 57 Park Avenue, New York 16, N. Y.)

Question:

What is the highest capacitance and greatest thickness of the disk-type ceramic capacitors achieved up to this time?

Answer:

Capacitors have been manufactured in the ranges of 7 to 10,000 $\mu\mu\text{f}$. They have a thickness in the range of approximately 20 to 40 mils.

Question:

What problems would one run into in applying printed techniques to wide band video amplifiers?

Answer:

There might be some problems due to the effects of distributed capacitance of the system at the higher frequencies. The Bureau of Standards has some experience with amplifiers in the VHF range and has obtained satisfactory gain-frequency characteristics. The losses in the material on which the circuit is printed may cause a loss of gain at high video frequencies. Rather than try to achieve miniaturization in the first step in a printed unit, it would be better to print the circuit in a convenient size and achieve standard performance first, then miniaturize the set. The Bureau of Standards is tackling the problem in two directions. They are trying to achieve good electronic perform-

ance in smaller packages by using conventional subminiature techniques as well as by the printed circuit method. Both methods appear very promising.

Question:

How does the capacitance vary with temperature in ceramic capacitors with a dielectric constant of 4,400?

Answer:

Standard performance tests on ceramic capacitors show that the capacitance-temperature curve has a sort of resonance effect. The capacitance increases with temperature up to a point and then decreases again. A dielectric constant of 4,400 seems to be rather high, but fairly constant performance across the temperature range has been achieved with dielectric constants up to 1,200.

Question:

What voltage ratings are possible in the ceramic dielectric capacitors?

Answer:

That depends upon the bodies concerned and the dielectric constant of those bodies. The higher the dielectric constant the lower the voltage rating will be. For a material with a dielectric constant of 90, a 10-mil sample breaks down somewhere between 7,000 and 10,000 volts on a flash test. With high K materials of the same thickness, breakdown is on the order of 1,600 to 2,200 volts. It has been found that at the peak dielectric constant breakdown is more probable than at either end of the range, or in other words at the Curie point.

Question:

What has been done in applying printed resistors to flexible bases?

Answer:

In one application a printed resistor material has been used in a phonograph pick-up. A small cantilever beam is made up with a printed resistor band on its sides so that the needle flexes the beam, thereby varying the resistance.³⁵ A current is passed through the resistor and the varying voltage across the resistor is used as the pick-up signal. Also, Mr. Marsten of International Resistance Co., described a cellophane base tape with resistance material printed on it. He stated that this tape resistor can be bent 160° without breaking or cracking the resistance film.

Question:

Can savings in procurement and distribution be executed in using printed circuits in field equipment?

³⁵ See "Printed Circuit Techniques" loc. cit.

Answer:

Savings in distribution and procurement in field equipment should be possible especially when modifications are made in equipment that has been made obsolete by new designs.

Question:

What will happen when a change of design has taken place in a unit and the stock of replacement units is depleted for older equipment? Will this mean that old equipment must necessarily be scrapped?

Answer:

If a stock should run down it would be a simple matter to run off a new stock. The machinery and equipment involved is not usually very complex and since a few stencils and dies can be stored rather easily, a stock could be replenished whenever necessary.

Question:

What is the maximum or the best tolerance which has been achieved in the production of printed resistors and are there any automatic adjusting processes for making printed resistors on the line?

Answer:

It has been found expedient to have very careful controls in existence in all stages of resistor processing. The economics of the problem more or less necessitates that in establishing large quantity production. Careful control is maintained over the processes at all times to insure high quality of the product. It is better to add a little additional cost to the controls over a process and particularly in the application of resistors to a plate so that a predetermined value is obtained, than it is to adjust the resistor after it has been applied. However, the value of a resistor can be adjusted after it is applied, in two ways: one is simply by scraping off or erasing³⁶ a little of the resistance material if the value is too low; the other is by painting over a resistor if its value is too high. In considering the components discussed in my paper earlier, where only two or three components in a set have been sectionalized, a certain number of these units continually keep going back to the beginning of the line for reprocessing. In other words, the yield might be 80 percent, and the 20 percent that do not conform to tolerances must go back to the beginning of the line to begin over again.—Mr. A. S. Khouri.

Question:

Has anything been done in connection with the magnetic paints mentioned earlier in the day?

³⁶ EDITOR'S NOTE: The standard glass-brush eraser works very well in this application.

Answer:

Not much information can be given since most of this work has been in the planning stage. Preliminary checks made at the National Bureau of Standards indicate that the inductance can be increased by using magnetic paint, but with lowered Q's as a result. This however, indicates that more experience is needed in making magnetic paints. It would be highly desirable to obtain a powdered magnetic material and completely surround the particles with an electrical non-conductor so that it may be painted over an inductor. The problem is amenable to solution.

Question:

Has anyone contemplated making resistors by spraying nichrome?

Answer:

We have done some work with nichrome in the field of radiant heating. Nichrome has been sprayed on plate glass but since this work has just started not much information is available at present. The process does work, however, and nichrome elements have been produced that should prove useful.—Mr. Gordon Johnson.

Question:

One of the speakers has indicated that although a considerable saving of space has been achieved in his firm's application of printed circuit production, costs were higher than with the use of conventional wiring. Is this generally true?

Answer:

Many organizations have found printed circuits more expensive in their preliminary experimentation with the process. It is only after the process has been placed into smooth production that one can evaluate the real cost. Information received from manufacturers show a substantial saving in cost of the final product even in limited production quantities.

(This section consists of answers to questions taken from the questionnaires submitted at the time of the symposium as well as questions which have subsequently been raised.)

Question:

What type of solder is recommended for circuits printed on steatite?

Answer:

A solder with a 2 to 4 percent silver added to saturate against further absorption of silver is recommended. Ordinary solder, however, can be used without too much difficulty.

Question:

What effect will potting have on the high ambient temperatures usually associated with miniaturized circuits?

Answer:

Potting will increase the working temperatures, hence components must be of higher quality in order to withstand the higher resultant ambients.

Question:

Is the general saving in cost using printed circuits due primarily to saving in simplified stocking and handling problems or are there other important savings possible?

Answer:

Savings are not restricted to stocking and handling but may be reflected from fewer wiring mistakes, fewer soldered connections, simplified testing procedures, and added production possible when the final design of a unit has been decided upon.

Question:

Is there any difficulty in obtaining reliable, noise-free connections in printed circuits?

Answer:

Little difficulty has been encountered in this matter. In those circuits made by firing the silver paint onto a ceramic, external leads may be soldered directly onto the conductors with good mechanical and electrical stability. Good connections can be obtained on plastics by the use of mechanically rigid eyelets, rivets, or clamps fastened to the printed circuit base plate before applying the conductor system by any one of the various methods described. These eyelets or rivets can then in turn be soldered.

Question:

Up to this time it seems that most of the printed circuit applications have been limited to miniature devices involving subminiature tubes. Since the cost of subminiature tubes is more than the others, I am wondering if it would be entirely practical to use standard tubes in conjunction with printed circuits or are the current carrying requirements too high?

Answer:

Printed circuits are not limited to subminiature low-drain tubes, as may be seen from at least two of the papers delivered here today. Actually, a printed silver conductor 0.04 in. wide and about 1 mil thick, fired on steatite is capable of carrying up to 8 amperes before opening. This is more than ample for the average electronic circuit but if a greater current

carrying capacity should be necessary it is a simple matter to increase the width or thickness of the conductor.

Question:

It seems that printed circuits require increased designing time and that this is a serious draw-back. Is this necessarily true?

Answer:

In some cases it may be necessary to spend more time in the lay-out of a unit but this is mainly due to the process being comparatively new. As experience is gained the time necessary in the design of a printed circuit unit will be less than that required for a unit of conventional design. In any event the advantages in high speed production possible with printed circuits greatly outweigh any increased time spent in the design.

Question:

Is there any difficulty involved in the assembly of equipment using printed circuits with the addition of standard components?

Answer:

Printed circuits adapt themselves well to combination with standard components. A saving in assembly time may be expected because of the increased simplicity and fewer soldered connections which are needed to complete the circuit.

Question:

How does the use of silver preparations for printing circuits compare with the cost of ordinary wire?

Answer:

Information gathered from various manufacturers using silver preparations find the cost about the same as that of tinned-copper wire. If the cost of solder is taken into consideration the total cost of materials alone will be less when printed circuits are used.

Question:

Can printed circuits be protected adequately against humidity?

Answer:

Printed circuits lend themselves well to protection against the effects of humidity. They may easily be coated with a resin thereby making them practically impervious to moisture. Low-loss resins such as the NBS casting resin prove very satisfactory for this purpose up through the VHF range.

Question:

Will thermal shock tend to loosen fired-on conductors after prolonged periods of time?

Answer:

Fired-on conductors, although they may have a different coefficient of expansion compared to the base plate on which they have been deposited, do not tend to loosen upon thermal shock if not too thick. A conductor assumes approximately the coefficient of expansion of the base-plate material since it is fused on, thereby becoming an integral part of the base plate. This should be a useful property in producing highly-stable inductors since the coefficients of expansion of ceramics, glasses, and quartz are lower than the metal of which inductors are usually made.

Question:

Will printed circuits make the testing of completed assemblies more difficult than present-day practices?

Answer:

Testing of printed circuits should be easier than with conventional circuits since printed circuits lend themselves to unitization. Individual units can be tested much the same as vacuum tubes as each unit is a replica of the master design. One manufacturer employs a completely automatic console for testing printed circuits.

Question:

How many manufacturers are planning to use printed circuits in hearing aids?

Answer:

Two manufacturers already have placed printed circuit hearing aids on the market; several more are planning similar units.

Question:

How complex have printed circuit units been made to date?

Answer:

In one commercial product, 45 individual parts have been replaced by a printed unit; another unit replaces 173 standard items.

Question:

What manufacturers produce conductor paints?

Answer:

Conductor paints are being manufactured by E. I. duPont de Nemours and Co., Inc., Wilmington, Del; Metaplast Co., New York, N. Y.; and Sauereisen Cements Co., Pittsburgh, Pa. A number of other companies have expressed interest in manufacturing paints suitable for conductor systems.

Question:

Are any manufacturers contemplating the production of printed circuit transmitters and receivers?

Answer:

A small transceiver, in which both the r-f and a-f sections will incorporate printed circuits, is now being manufactured by one firm. Several other manufacturers are contemplating production of equipment utilizing printed circuits.

Summary of Questionnaires

Of the estimated 700 persons attending the Printed Circuit Symposium, 527 submitted answered questionnaires. From these questionnaires, prepared by the printed circuit committee, much information may be had on the outlook for printed circuits in both Government and industry. The pertinent questions were as follows:

6. Do you believe that another symposium on PC would be desirable?
In how many months? Where?
7. Do you believe PC will achieve miniaturization?
8. Do you believe PC will result in efficient design?
9. Do you believe the substitution of PC will reduce costs?
11. What is your firm's interest in PC work? (check applicable boxes)
Planning, in near future.
Actively engaged.
General interest.
12. In what phase of PC work is your firm interested?
Research or development of PC.
Manufacturing PC assemblies.
Using PC assemblies.
13. What in particular would you like to see PC technique applied to?
Describe.
14. What outstanding design feature have you (your firm) accomplished in the application of PC technique? (Check applicable boxes)
Miniaturization. Low cost production.
Efficient design.
Describe.
15. What difficulties do you anticipate in the use of PC techniques?

The results of these questionnaires are recorded in the following table 1. The questionnaires have been grouped according to industry, Government, and other interested parties.

TABLE 1.—Percentage replying in the affirmative to the question asked

Question	Total (approximately 500 replies)	Industry (approximately 300 replies)	Government (approximately 150 replies)	Miscellaneous (approximately 20 replies)
	Percent	Percent	Percent	Percent
6 -----	97	96	99	95
7 -----	98	97	98	100
8 -----	95	95	95	100
9 -----	85	83	86	93
11 (a) ¹ -----	38	37	45	55
11 (b) -----	20	23	16	25
11 (c) -----	55	60	55	55
12 (a) ¹ -----	50	53	51	75
12 (b) -----	35	50	14	30
12 (c) -----	60	60	72	55
14 (a) -----	13	16	10	20
14 (b) -----	7	11	1	10
14 (c) -----	10	14	3	10

¹ These items total greater than 100 percent since some individuals checked more than one of the three.

It will be noted that the response from industry and Government was approximately the same and hence in evaluating the results, one can deal almost entirely with the totals rather than the break-down. Considering each of the questions individually:

(6) Ninety-seven percent felt that another symposium on printed circuits would be desirable. Of these the majority preferred the symposium to be held within 6 to 12 months and preferably in Washington, with New York second, Chicago third, and remainder distributed between various cities in the East, Mid-west, West Coast and the South.

(7, 8) Ninety-five to ninety-eight percent of those present believed that printed circuits would result both in miniaturization and in efficient design.

(9) Eighty-five percent felt that the substitution of printed circuits for standard methods of producing electronic circuits would reduce costs.

(11) It was possible to answer this question more than once, such as for example if a plant was not only actively engaged in doing printed circuit work but also was planning to expand their activities into other directions in the near future. Hence, the percentages of replies will total greater than 100 percent as some of the individuals checked more than one of the three parts of this question. It is interesting to note that as many as 38 percent are planning to use printed circuits in the near future. Twenty percent are already engaged in this development and 55 percent showed general interest.

(12) As high as 50 percent of the organizations represented were interested in research or development, 35 percent were interested in manufacturing and 60 percent were interested in applying printed circuits to their products.

The figure of 35 percent for those interested in manufacturing is an average which should perhaps be resolved by saying 50 percent of the 300 replies received from industry showed interest in manufacturing electronic assemblies whereas only 14 percent of the Government replies indicated this interest.

(14) It was surprising to note that although printed circuits are considered something new, as many as 13 percent of the 527 replies showed that their organizations had already accomplished miniaturization through the use of printed circuits, while 7 percent had already accomplished low cost production and 10 percent had already accomplished efficient design. The first public release of information on printed circuits was made by the National Bureau of Standards in February 1946. The above figures are even more significant when it is considered that a large part of the audience came principally to learn about printed circuits for the first time.

The answers to question (13), were of such wide variety that it was found necessary to group them in broader categories. The question was not answered in every instance by those submitting the questionnaires, however, sufficient data were gathered to show definitely where the main interest in the application of printed circuits is and should give a good indication as to where one may expect to find printed circuits used in the future. These categories are listed below in the order of interest expressed. The magnitude of interest as reflected in the number of replies is shown in parentheses following the categories. Note the interest expressed in the application of printed circuits to the manufacture of home type AM and FM radio receivers.

1. Home receiving equipment (AM and FM) (35)
2. Aircraft radar and navigation equipment (25)
3. Television receivers (24)
4. Radar equipment (general) (22)
5. Aircraft communication equipment (22)
6. Military communication equipment (19)
7. Audio frequency amplifiers (18)
8. Test equipment and instruments (17)
9. Citizens radio and transceiving equipment (17)
10. Transmitting equipment (14)
11. Hearing aids (13)
12. Frequency control equipment (11)
13. Special circuits (sync, sweep, trigger, etc.) (10)
14. Ordnance equipment (8)
15. Switch Boards and panels (6)
16. Telemetering equipment (5)
17. Industrial electronic controls (4)
18. Recording equipment (4)
19. Computing equipment (3)
20. Power supplies (3)

Question 15 inquired as to what difficulties were anticipated in the use of printed circuit techniques. Typical difficulties expected in the use of printed circuits were question of cost, the effects of high capacitances in wiring, choice of base materials, replacement of defective units, instability of disk-type high dielectric capacitors, the effect of mechanical and thermal shock, standardization of techniques and materials, tolerances of components, and difficulties in making external connections. This subject is dealt with further in the general discussion.

RESEARCH
DEVELOPMENT
STANDARDS
TESTING

PHYSICS
MATHEMATICS
CHEMISTRY
ENGINEERING

The Technical News Bulletin of the National Bureau of Standards

- A monthly periodical
- . 12 or more pages an issue
- . Annual subscription, \$1.00

- Preliminary reports on research and development projects in progress.

- Concise articles summarizing completed research projects.

- Reports on new instruments, scientific constants, standard samples, commodity standards, new measurement techniques, properties of materials, calibration services, and codes and specifications.

- Lists of all Bureau publications during the preceding month: research papers, handbooks, applied mathematics series, building materials and structures reports, simplified practice recommendations, commercial standards circulars, letter circulars, and miscellaneous publications.

- The articles in the Bulletin are concise and clear. In addition to a description of the research, development, or discovery, each major article indicates the significance of the work in science and its application in industry. Drawings and illustrations are used where helpful.

The Technical News Bulletin can be ordered from the Superintendent of Documents, U. S. Government Printing Office, Washington 25, D. C.

Subscription price:

Domestic \$1.00 a year
Foreign countries \$1.35 a year