

*HOW TO  
AND*

**DESIGN  
SPECIFY**

**PRINTED  
CIRCUITS**

*A Publication of*

**THE INSTITUTE  
OF  
PRINTED  
CIRCUITS**

27 EAST MONROE STREET  
CHICAGO 3, ILLINOIS

**BOARD OF CONTRIBUTING AND CONSULTING EDITORS**  
**"HOW TO DESIGN AND SPECIFY PRINTED CIRCUITS"**

K. W. Anderson  
Melrose Park, Illinois

W. J. McGinley  
Chicago, Illinois

William Carlsen  
Waltham 54, Massachusetts

T. M. Navoy  
Lowell, Massachusetts

K. W. Clayton  
Chicago, Illinois

P. P. Pellegrino  
East Rochester, New York

J. E. Currier  
Stamford, Connecticut

R. C. Rennie  
Minneapolis, Minnesota

R. K. Hansen  
Patterson, New Jersey

Charles Sabel  
Mt. Vernon, New York

G. J. Hart  
La Puente, California

J. R. Sibley  
Haddam, Connecticut

A. R. Hughes  
Needham Heights, Massachusetts

R. L. Swiggett  
Glen Cove, New York

A. J. Lorenz  
Brookfield, Massachusetts

R. G. Zens  
Natick, Massachusetts

## TABLE OF CONTENTS

Inside Front Cover.....	Board of Contributing and Consulting Editors
TABLE OF CONTENTS.....	PAGE 1
ABOUT THE INSTITUTE OF PRINTED CIRCUITS.....	PAGE 2
INTRODUCTION.....	PAGE 3
TERMINOLOGY AND DEFINITIONS.....	PAGE 4-11
ADVANTAGES OFFERED BY PRINTED CIRCUITS....	PAGE 12-15
APPLICATION OF PREFABRICATED WIRING.....	PAGE 16-20
PRODUCTION METHODS.....	PAGE 21-27
PROCESSING LIMITATIONS.....	PAGE 28-30
LAYOUT AND DESIGN.....	PAGE 31-41
Initial Layout.....	PAGE 31, 32
Conductor Width.....	PAGE 33, 34, 35
Conductor Spacing.....	PAGE 36
Mechanical.....	PAGE 37
Dimensional Considerations.....	PAGE 37, 38
Size Considerations.....	PAGE 40
Component Layout and Mounting.....	PAGE 41
Current.....	PAGE 42
Leakage Resistance.....	PAGE 42
Fabrication Considerations.....	PAGE 42, 43
SWITCH PLATES AND COMMUTATOR DISCS.....	PAGE 43, 44
Characteristics of Printed Circuit Switch Plates and Commutator Discs.....	PAGE 45
SELECTION OF MATERIALS.....	PAGE 46
Foil.....	PAGE 46
Plastics.....	PAGE 46

Copper Clad Plastics Now In Use Description and Application.....	PAGE 47
Special Materials.....	PAGE 48
Characteristics of Copper-Faced Laminates (Typical).....	PAGE 49
SELECTION OF COMPONENTS.....	PAGE 50-59
Components with "Pig-Tail" Leads.....	PAGE 50
Printed Circuit Connectors.....	PAGE 50, 51
Advantages of Special Component Basings for Coils and Tubes.....	PAGE 52-55
Component Applications of "Printed Circuitry".....	PAGE 56, 57
ARTWORK.....	PAGE 58, 59
FINISHES.....	PAGE 60
UNDERWRITERS LABORATORY APPROVAL.....	PAGE 61
PRINTED CIRCUIT ASSEMBLY.....	PAGE 62-65
AUTOMATION.....	PAGE 66-68
MULTIPLE SOLDERING TECHNIQUES.....	PAGE 69-73
Materials Required.....	PAGE 69
Fluxing.....	PAGE 70
Dip Soldering.....	PAGE 71
Cleaning.....	PAGE 72
Summary On Soldering.....	PAGE 73
SERVICE AND REPAIR OF PRINTED CIRCUITS.....	PAGE 74-76
I. P. C. TOLERANCES.....	PAGE 77-83
RELIABILITY.....	PAGE 84-88
GOVERNMENT SPECIFICATIONS APPLICABLE TO PRINTED CIRCUITS.....	PAGE 89
BIBLIOGRAPHY.....	PAGE 90, 91, 92
INSIDE BACK COVER.....	MEMBERS OF INSTITUTE OF PRINTED CIRCUITS

## ABOUT THE INSTITUTE OF PRINTED CIRCUITS

The Institute of Printed Circuits is a voluntary non-profit organization initially formed by a group of independent fabricators. Its prime objective is in the furtherance of the interests of the printed circuit concept and its application to all industries. It will accelerate the growth and acceptance of printed wiring by study and publication of its advantages.

While the electronic industry has been the first to adopt and is the largest user of printed circuits, and service to that industry is a major interest of many members, the IPC wishes to promulgate adoption of printed circuits in all proper applications where any sort of wiring is now employed. This trade association may thus have interests in the appliance, automotive and electrical manufacturing industry as well as in electronics.

IPC membership comprises the leading independent fabricators of circuit boards, divisions and departments of firms making these products for internal use and manufacturers of materials, equipment and supplies. IPC expects to assure customer satisfaction with printed circuit products by education of users, standardization of requirements and tolerances, and promulgation of data assuring sound design and operational usage.

IPC organizes meetings for the voluntary exchange of information on problems and developments within the industry and establishes a working liaison between manufacturers and suppliers associated with printed circuits. It expects to educate the management and working personnel of the printed circuit industry to better manufacturing and marketing practices.

It will aid its membership by condensation and interchange of technical and statistical information on the field. Finally, it will act in behalf of the industry in its relations with government, technical societies and other organizations associated with printed circuits. Users will benefit from the services of sound suppliers realistically representing their abilities and services.

## INTRODUCTION

This presentation embodies the collective knowhow of pioneer firms in the manufacture of printed wiring devices with respect to manufacturing experience on thousands of circuit applications. Its purpose is to assure success of new applications and minimize engineering and manufacturing errors by presenting sound and simple methods of design and specification. Individual member firms of the IPC are happy to provide additional and more detailed recommendations on consultation.

This booklet is a general technical explanation of the sequence in adapting electrical and electronic wiring circuits to a single or co-planar printed wiring connecting structure. Use of the printed circuit technique is in most cases considerably more simple than would appear at first glance, but it does require the designer to plan with detail how he will use the available building blocks in the form of standard and special components.

The printed circuit industry is an infant business, and much of its trouble and a larger share of those disappointments in its values have resulted from unrealistic impressions of the technical features which can be furnished on a reliable production basis. After several years of constantly wider application with successful uses far outweighing the disappointments, the industry is at a stage where its abilities can be defined and its features demonstrated on the basis of performance. Practically all devices employing transmission of electrical energy in medium to high density collections of low current wiring have now employed printed wiring.

The product uniformity and cost savings inherent in this technique can be readily engineered and profitably used if the approach is well evaluated and the design planned carefully enough to assure reasonable tolerances on the circuits themselves and reliable employment of associated components.

## TERMINOLOGY AND DEFINITIONS

### Printed Circuit Board: (or Printed Wiring Board)

A conductive pattern reproduced on an insulating base material.

### Base Material:

An insulating material (usually a copper-clad laminate) used to support a conductive pattern.

### Conductive Material:

A metallic foil, usually copper, which is bonded to the base material.

### Land: (or; Boss, Pad, Terminal point, Blivet, Tab, Spot, Donut)

The conductive area to which components or separate circuits are attached, usually surrounding a hole through the conductive pattern and the base material.

### Conductor: (or; Printed Lead)

A single conductive line forming an electrical connection between two or more locations.

### Conductive Pattern:

The configuration or design of conductive lines.

### Plug-in Connection: (or; Connector Contact Area, Fingers)

Conductor termination points brought out to the edge of a printed circuit board for purpose of plugging the board into a printed circuit connector.

### Circuit Holes:

Any hole which lies partially or completely within the conductive area.

### Mounting Holes:

The holes used for mechanical assembly for a printed circuit board to a chassis.

### Polarizing Slots: (or; Indexing Slots)

One or more slots in the edge of a printed circuit board, used to accommodate and align certain types of printed circuit connectors.

### Connection:

A method by which components are attached to the conductive pattern, usually by means of holes through the conductive pattern and base material through which component leads pass. Normally the leads are soldered to the conductors at the lands.

### Thru-Hole Connection: (or; Feed-thru connection, Plated Thru-hole)

A conductive material used to make electrical and mechanical connection from the conductive pattern on one side, to the conductive pattern on the opposite side of a printed circuit board.

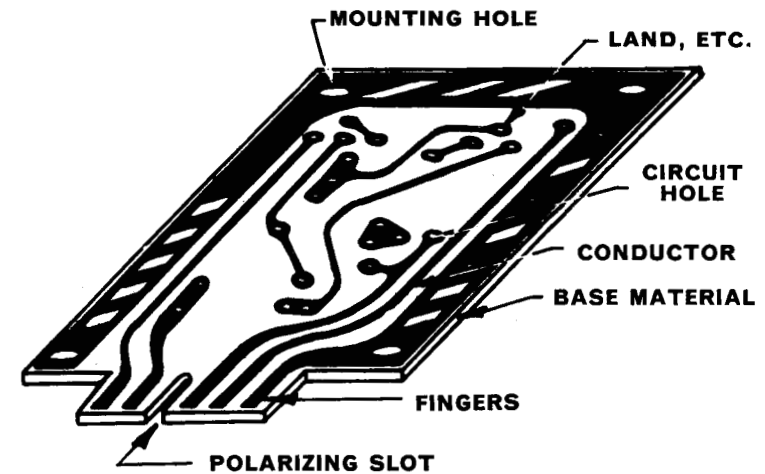

TYP. PRINTED CIRCUIT

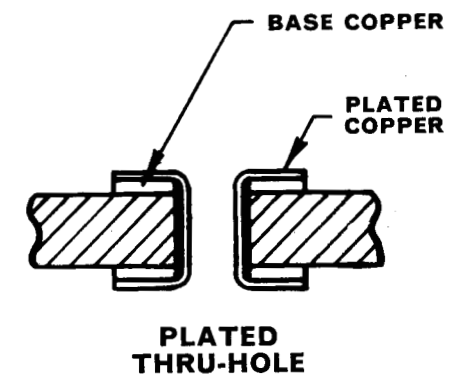
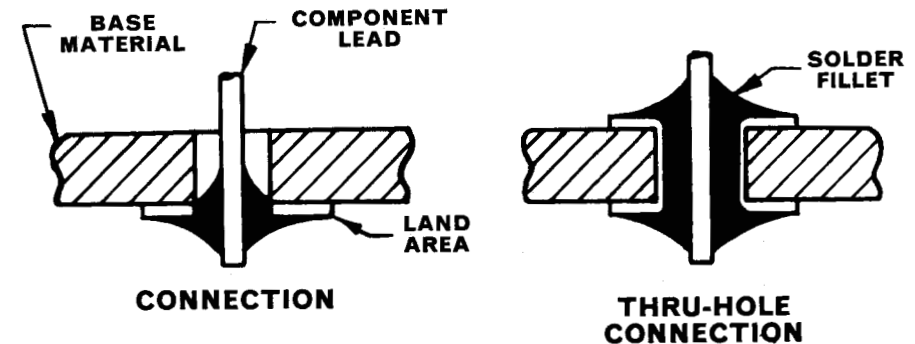

PLATED THRU-HOLE

**Printed Circuit Assembly:**

A printed circuit board to which separable components have been attached. Also, an assembly of one or more printed circuit boards which may include several components.

**Component:**

A separable part of a printed circuit board assembly such as a resistor, condenser, transformer, etc.

**Printed Component:**

An inseparable part of a printed circuit board, intended primarily to provide an electrical and/or magnetic function, other than forming an electrical connection between two locations.

**Hardware:**

A separable part of a printed circuit board assembly such as an eyelet, terminal, bracket, etc.

**Eyelet (Flat Flange or Rolled Flange):**

A tubular metal piece having one end headed or rolled over to, or to exceed a plane which is at a right angle to the axis of the tubular portion. The second end would be similarly formed during installation.

**Tubelet: (or ; Funnel-flanged Eyelet)**

A tubular metal piece having one end formed in a conical flare of approximately 90 degree included angle. The second end would be similarly formed during installation. The purpose of the tubelet is to increase the reliability and durability of the soldered joint, over that for eyelets or plain holes.

**Terminal Lug:**

A cylindrical piece of metal either solid or hollow of two or more diameters which can be staked, flared, swaged or pressed into a hole for the purpose of connecting leads or external wires to the conductive pattern.

**Dip Soldering:**

The process of soldering component leads, terminals and hardware to the conductive pattern on the "bottom" side of a printed circuit board by "dipping", or floating, that side on the surface of a molten solder bath.

**Solderability:**

The ability of the conductive pattern on a printed circuit board to be wet by solder.

**Fabrication:**

Any mechanical operations performed to put holes in, and/or cut to size, a printed circuit board such as drilling, piercing, routing, sawing and blanking.

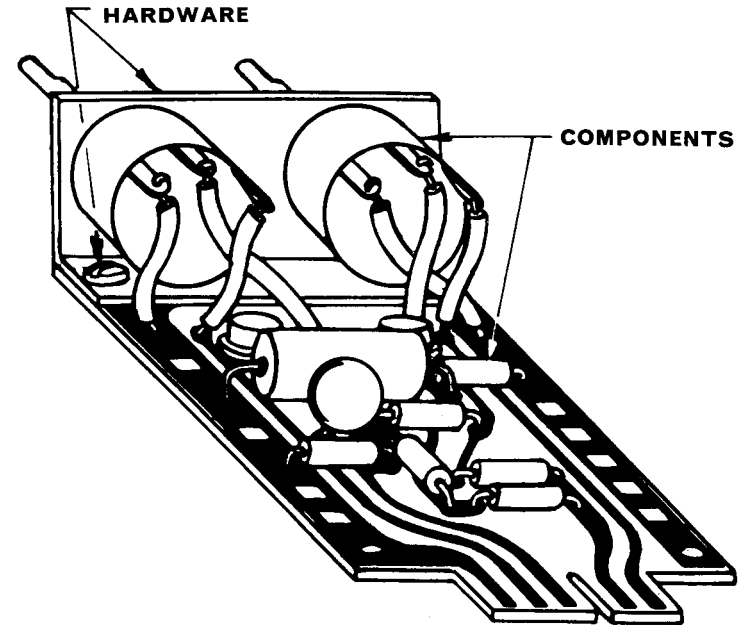

**TYP. PRINTED CIRCUIT ASSEMBLY**



**EYELET**



**TUBELET**

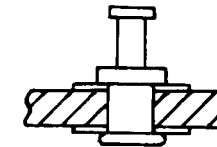

**TERMINAL LUG**

**Pilot Holes: (or; Manufacturing Holes, Fabrication Holes)**

Holes in a printed circuit board, or in the web, used as guides in processing and fabrication. (Mounting holes in a part are sometimes used as Pilot Holes.)

**Processing:**

Any electro-chemical or chemical operations necessary to produce a printed wiring board.

**Finish:**

Any added material such as an electrodeposited plating, or coating such as water-dip lacquers, insulating fluxes, varnishes, etc., placed over the conductive pattern as an aid to soldering and/or protection. Solder-resists are also included, but are used primarily to prevent soldering of certain areas.

**Silver Migration:**

The ionic displacement of metallic silver through an insulating medium; usually caused by a combination of conditions of extended time, high humidity, temperature variations and D. C. potential.

**Current Carrying Capacity:**

The maximum current which can be continuously carried by a given conductor without causing permanent deterioration of electrical or mechanical properties of the printed circuit board.

**Master Drawing: (or; Artwork, Photomaster)**

An accurately scaled black-on-white drawing on a dimensionally stable material as required for photographic reproduction and/or reduction.

**Marking Drawings: (or; Nomenclature)**

Printed lettering or symbols on the printed circuit board indicating part numbers, component locations, etc. Either etched or printed by depositing an insulating lacquer by means of screen or stencil processes.

**Reference Dimension:**

On the master drawing is an actual size accurate dimension which is used to check the photographic reduction.

**Center Spot: (or; Bullseye)**

A locating circle in the center of a land, or boss.

**Shielding:**

The use of large conductive areas for electrical purposes, such as a ground.

**Cross-Hatching:**

Breaking up of large conductive areas where shielding is required.

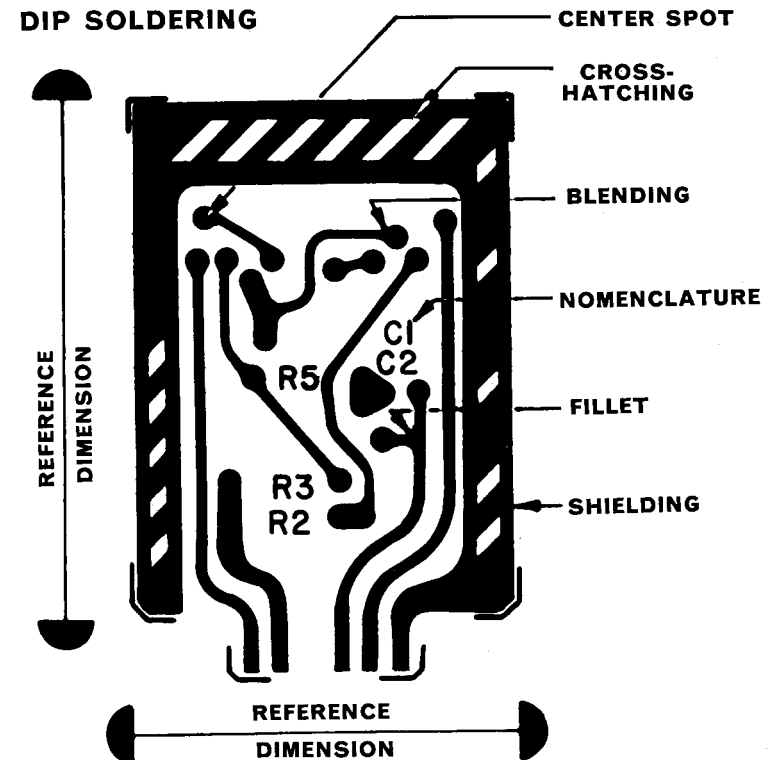
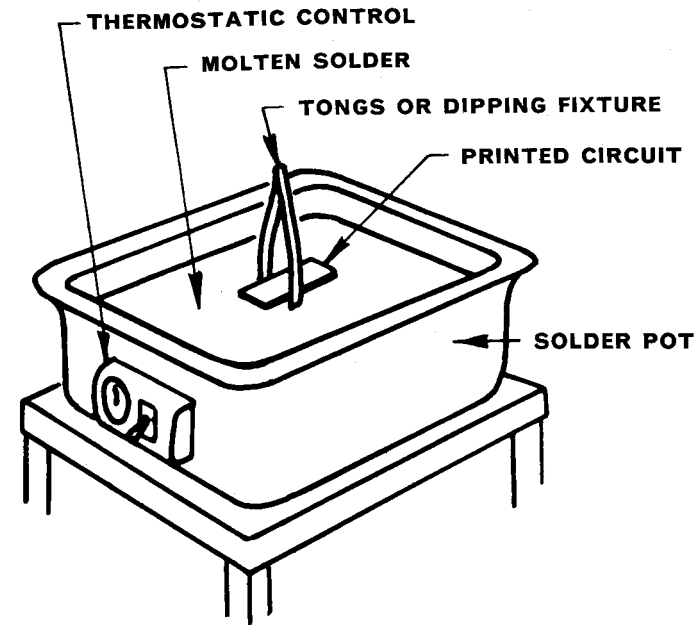

**Fillet:**

A blending or rounding of intersecting conductors and/or lands which eliminate sharp corners. Also—build up of solder around a component lead, etc.

**Registration-Conductive Pattern-to-Holes:**

The location of the printed, or conductive, pattern with respect to the holes.

**Registration-Front-to-Back:**

The location of the printed pattern on one side of the board with respect to the printed pattern on the opposite side.

**Registration-Conductive Pattern-to-Board-Outline:**

The location of the printed pattern with respect to the overall outline dimensions of the printed circuit board.

**Definition:**

The sharpness and accuracy of the conductive pattern as reproduced on the printed circuit board from the Master Drawing.

**Undercut:**

The reduction of conductor cross section caused by etchant removal of conductive metal under the edge of the resist.

**Overhang:**

The plated-resist-metal remaining after original conductive metal removed by undercutting.

**Resist Plating:**

Any material which, when deposited on conductive areas, prevents the **plating** of the areas it covers.

**Plated-Resist:**

Any material which, when electro-plated on conductive areas, prevents the removal by **etching** of the areas it covers.

**Resist-Etchant:**

Any material deposited on the surface of a copper-clad base material that prevents the removal by etching of the conductive area it covers.

**Bond Strength: (or Peel Strength Adhesion)**

The measurable adhesion between the conductive material and the base material.

**Warpage:**

The deviation from a plane surface measured across length or width.

**Twist:**

The deviation from a plane surface measured from one corner to the diagonally opposite corner.

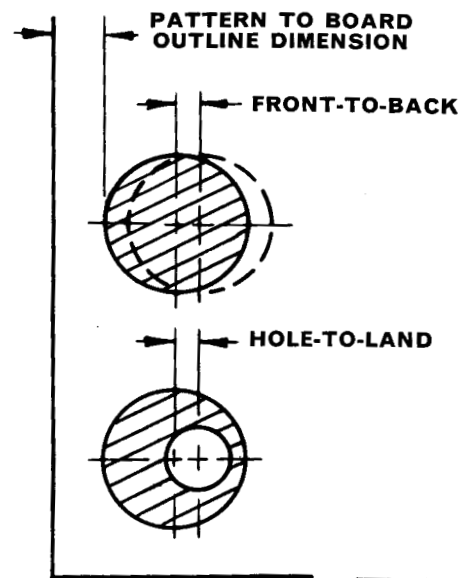
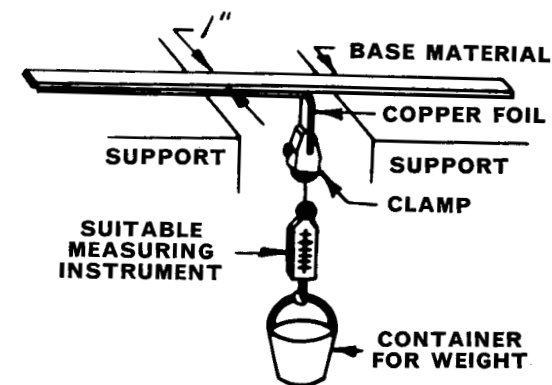
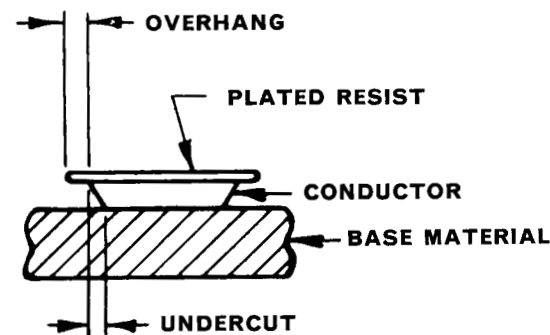
**REGISTRATION****BOND STRENGTH TEST****PLATED & ETCHED CONDUCTOR CROSS SECTION**



## ADVANTAGES OFFERED BY PRINTED CIRCUITS

The advantages of printed circuits are numerous, and for commercial applications are usually studied initially from the standpoint of size, labor and cost reduction.

For military applications, the advantages in miniaturization are quite obvious and the possibilities of uniformity and reliability are equally attractive. Printed circuits lend themselves to "decking" and encapsulation, and the minimizing of dead space in assembly, as well as simplify the design of unitized equipment.

Freedom from wiring errors and independence from highly developed labor skills are advantages in any mass production application of electronic circuitry, and the limitations imposed by the availability of bench workers in periods of rapidly expanding production are readily apparent. Also important are the reductions in factory floor space which printed circuits and semi-automatic or automatic assembly offers.

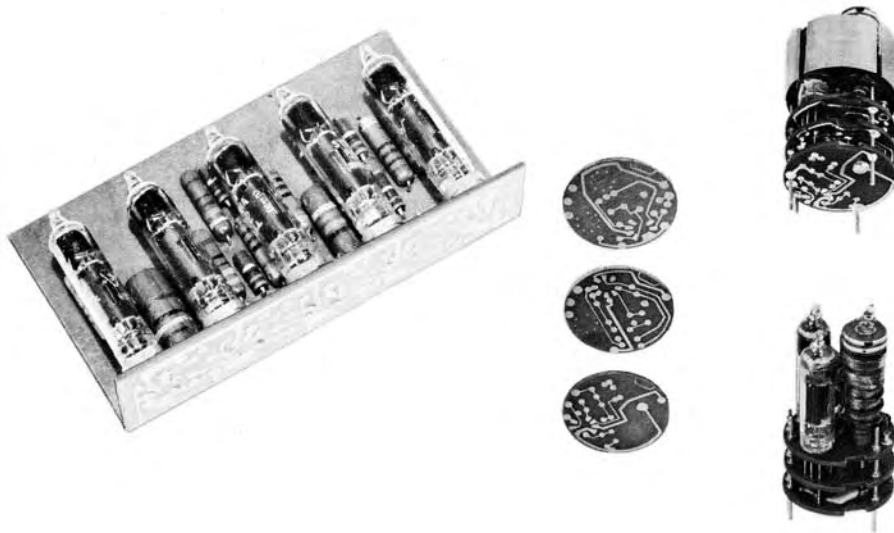

Two developments of Signal Corps Engineering Laboratories illustrate interesting applications of prefabricated wiring. Left illustration shows use of post forming laminate for right angle circuit panel permitting horizontal tube placement. Right photograph shows "decking" of multiple boards, inter-connected by jacks and pins. Each deck may contain one major segment of entire circuit.

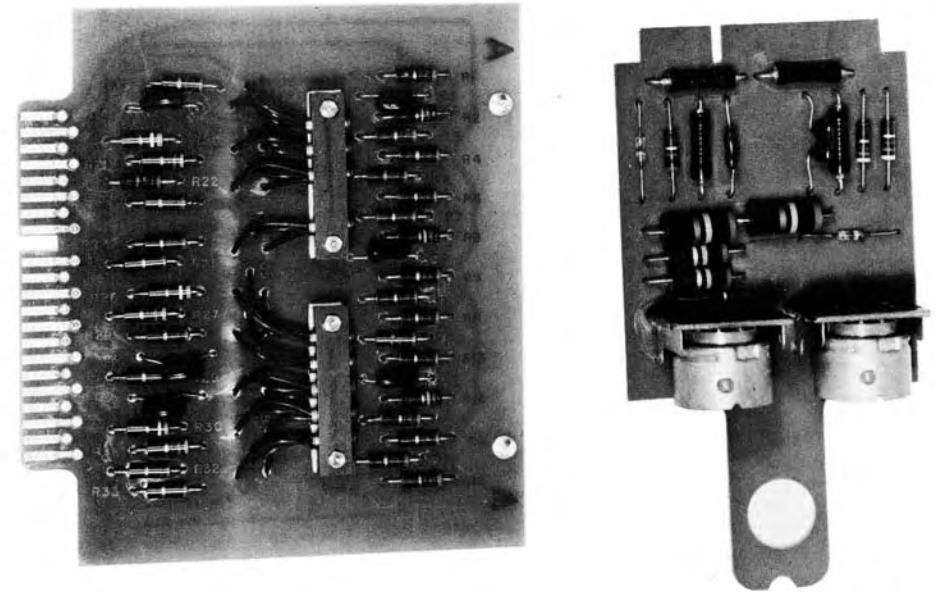
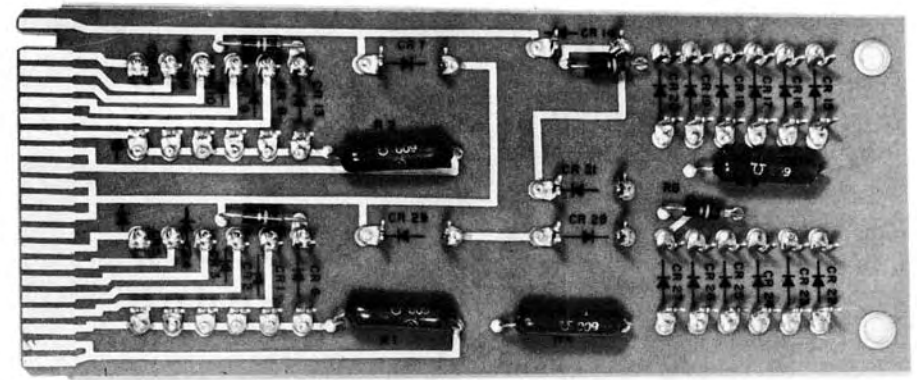

Use of smaller plug-in boards for computers is a definite trend.

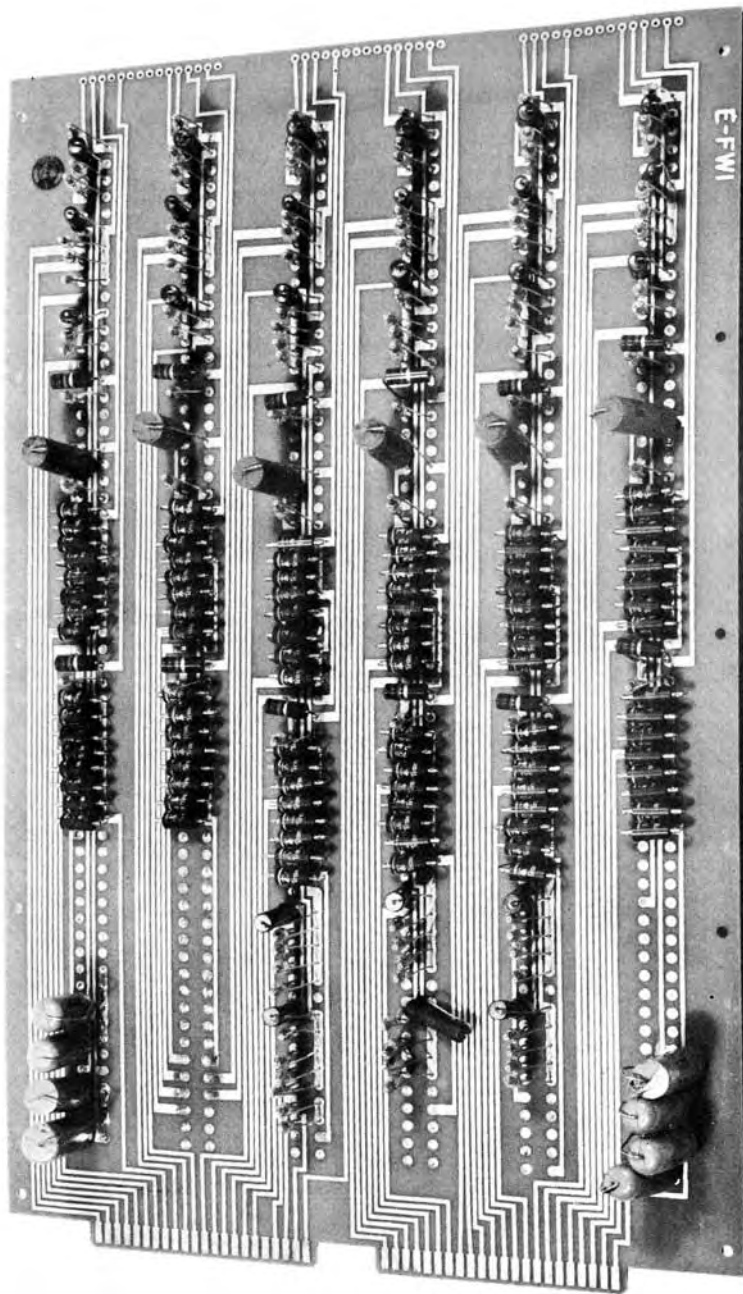

Large plug-in computer board.

The uniform positioning of wiring and circuit elements permits design of equipment nearer "spill-over" point, with resultant higher performance levels possible on a production basis. Control of feedback and other conditions resulting from inter-relationship of leads and components can be carefully planned in the design stages without the usual concerns with regard to variation in production units. Capacity and inductance uniformity is readily controlled since it is affected only by the close limits within which conductor sizes and the dielectric characteristics of the insulating material can be held.

Critical conductors can be isolated by incorporating shielding as a part of the conductor pattern. Where advantageous, low value capacitors and inductors can also be an integral part of the conductor pattern. Design changes during production runs can be accomplished readily by revising the master drawing.

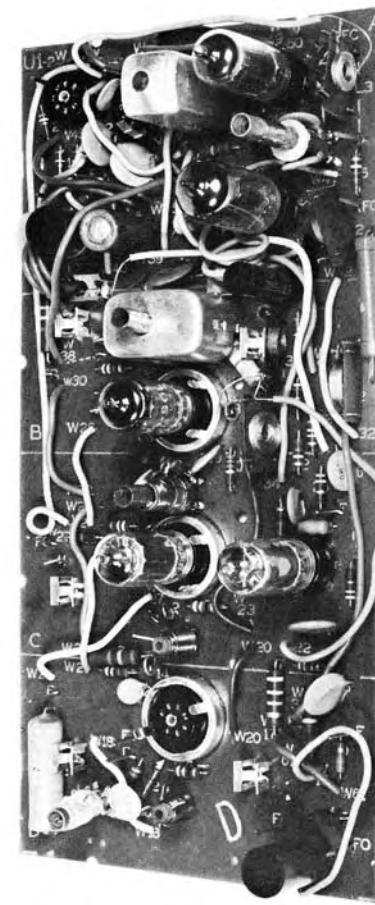

Complete television panel assembly containing all units except tuner and high voltage section.

## APPLICATION OF PREFABRICATED WIRING

### Commercial Utilizations

The use of prefabricated wiring is specifically restricted only by the amount of current which printed conductors must carry and the limitations imposed by the inherent mechanical characteristics of flat current carrying leads bonded horizontally to dielectric board segments. Thus, any device employing more than the simplest of wiring arrangements with low to medium power loads can exploit the potentialities of the process for competitive and design advantage. With special materials, printed circuits are producible on right angle, cylindrical, "U" shaped or other irregular planes, features which can be utilized to replace dead space in many applications. Similarly, two or more boards may be mortised together to achieve right angle layouts. Such diverse products as stop and go light controls, electronic temperature regulators, radiac and electric organs present novel and interesting application possibilities.

The complex wiring arrangements in business machines offer many possibilities for advanced usage of prefabricated wiring techniques. The space conservation requirements of hearing aids have resulted in a widespread utilization of the techniques in these products. Most large receiver manufacturers now are mass producing radios utilizing prefabricated wiring techniques and the general success of these ventures and the considerable progress being made in perfecting high production techniques has been a great stimulus to the rapid advancement of the concept.

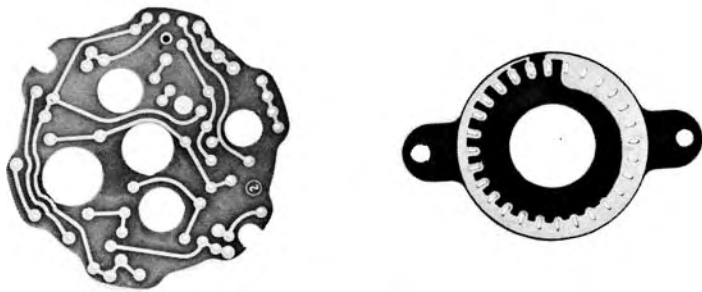

Proximity fuse plate and stepper switch are among the military applications of printed circuit panels.

Printed wiring units in television tuners have been used for some time, and several of the UHF tuners and converters have successfully employed etched strips, switches or segments. The natural division of video receivers into various stages lends itself to a gradual conversion to the new concepts with thorough laboratory and field testing possible as the transition progresses.

Utilization of properly designed printed circuit boards for wave guides has enjoyed success and offers tremendous savings over conventional "plumbing" used in microwave installations. Printed coils have been produced successfully within closer limits than possible with wound inductances, and offer considerable advantages in ruggedization and cost. Loop antennas have been a large volume application of prefabricated wiring techniques.

Appliance and automotive applications of printed wiring have been limited to date, but offer considerable opportunity for savings. Studies are currently under way for utilization in stoves, washing machines, water heaters, dash panels, electrical toys, etc.

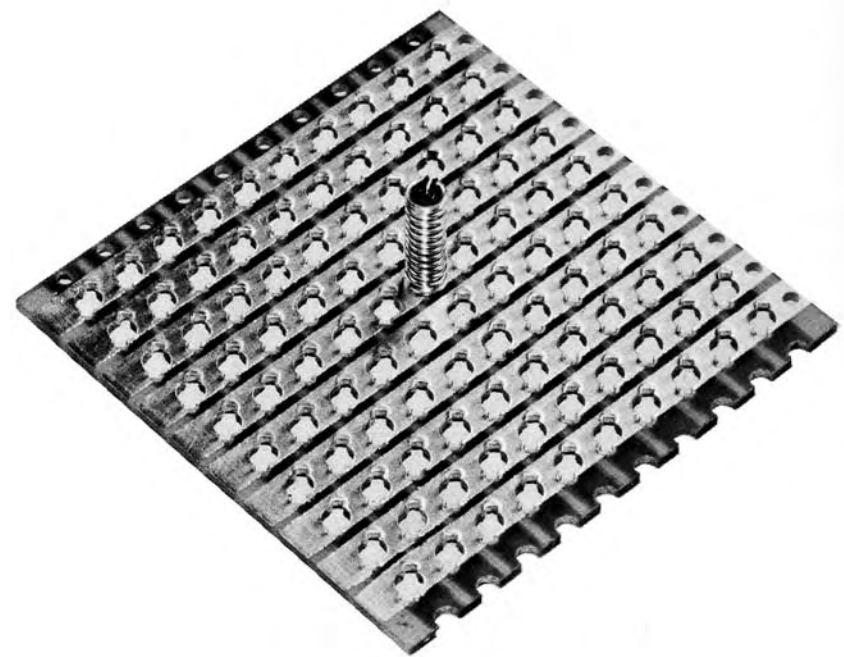

2 sided etched circuit matrix provides vertical and horizontal bus bars for selective inter-connection.

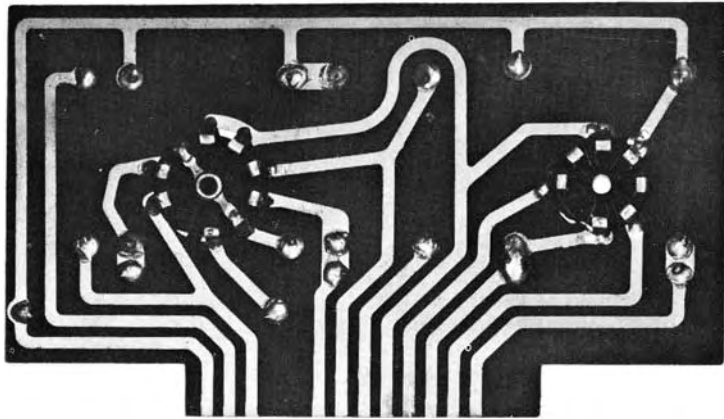

Instrument applications of printed wiring are illustrated by this colorimeter panel employed in device for testing viscosity.

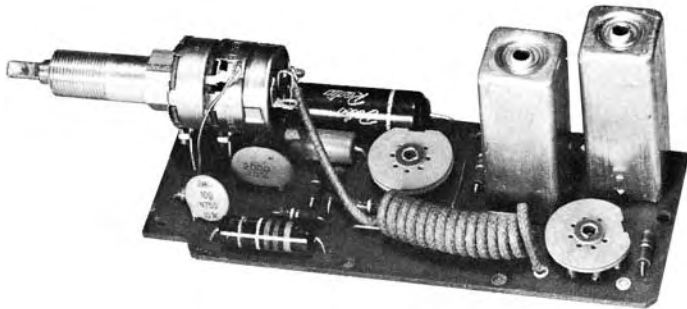

Automotive applications include dash panels, dimmer switches, distributor rotors, air conditioner controls as well as radio circuitry illustrated above.

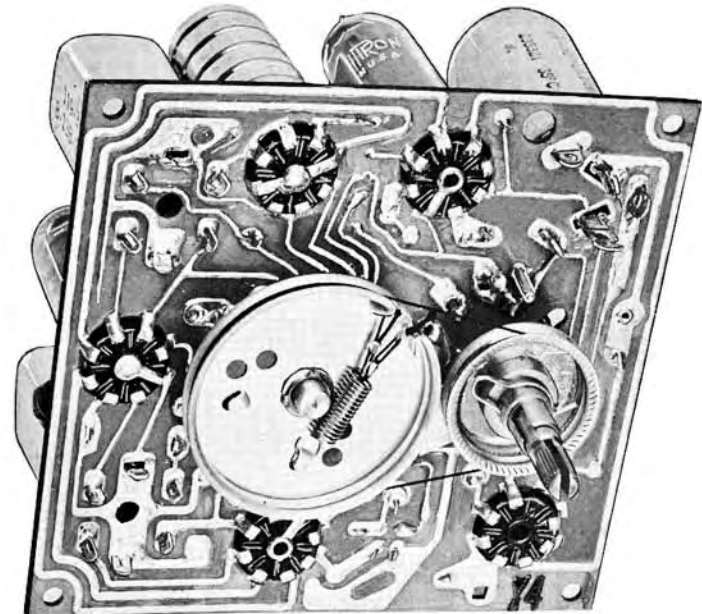
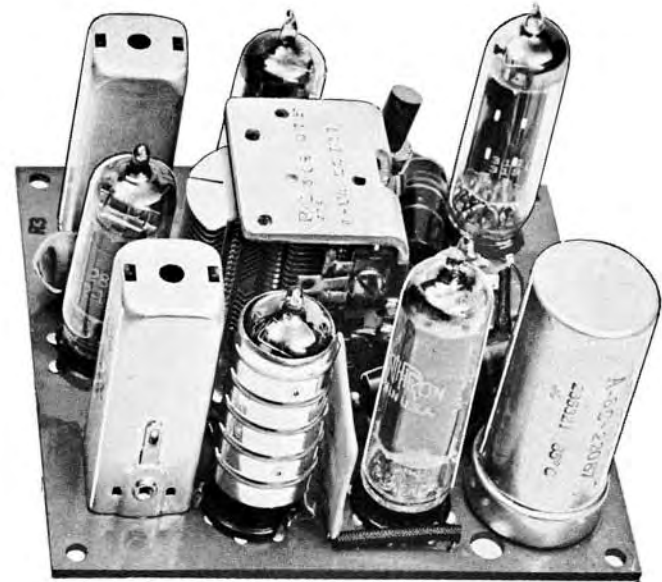

2 views of 5 tube radio chassis assembly.

## Military Applications

Applications of "printed circuitry" in guided missiles, proximity fuses, etc., are naturally in the restricted category but radio transmitters and receivers, radar, sonar, fire control, servo amplifiers, glide path apparatus and computers are among the classes of equipment which have made extensive use of the art.

The principle of unitized construction with "throw away" segments, which military service requirements often dictate, is a natural for application of the "printed circuit" approach. The majority of military electronic devices lend themselves to effective use of prefabricated wiring, and the work of the Signal Corps., Bureau of Standards and other governmental and public organizations in the medium has been and undoubtedly will continue to be a great stimulus to further development.

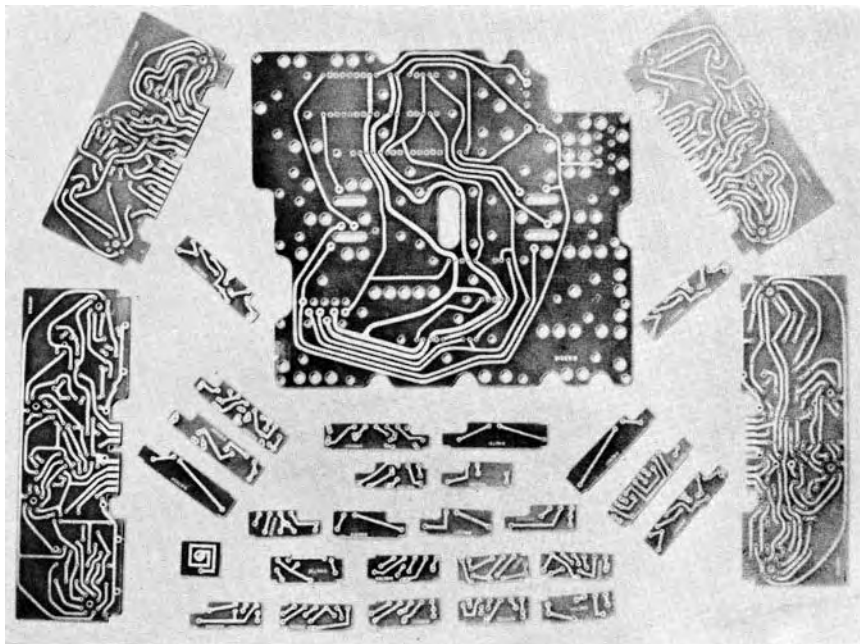

Kit of printed circuit components used in guidance equipment of Artillery Range Missile.

## PRODUCTION METHODS

Processes for producing printed circuits fall into two categories—additive and subtractive.

In the additive process a conductor delineating the circuit pattern is applied to an insulator by methods such as embossing or die-stamping a metal foil, pressed powder fusing, sprayed molten metal, conductive paints, electroforming or plating on unclad insulators.

In the predominately used subtractive process the circuit configuration is delineated by removing unwanted areas of conductor from the surface of the insulator. The most common method of removal is etching. In the etching process an acid resistant coating conforming to the circuit pattern is applied to the surface of a metal clad plastic. Exposed unwanted areas of metal are then etched off by subjecting the sheet to a suitable etching solution. The acid resistant coating is then removed thereby leaving the conductive metal in the form of the desired circuit pattern.

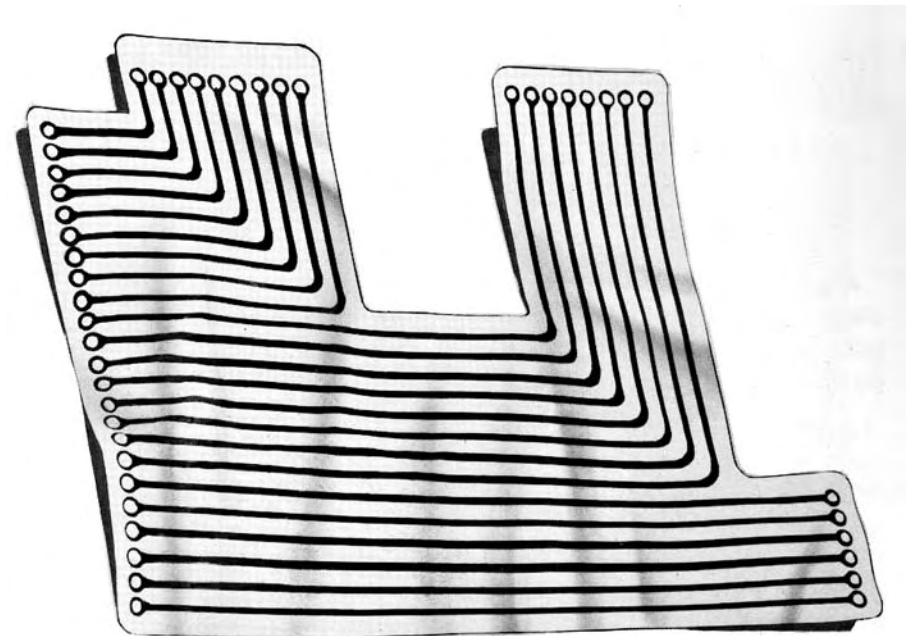

Among special types of circuits now being used for particular applications is the flexible dielectric conductor pattern. Such circuits are particularly useful where it is desirable to line an enclosure, conform to an irregular contour, serve a harnessing function with the maximum conductivity to weight ratio or where long flex-life is desired.



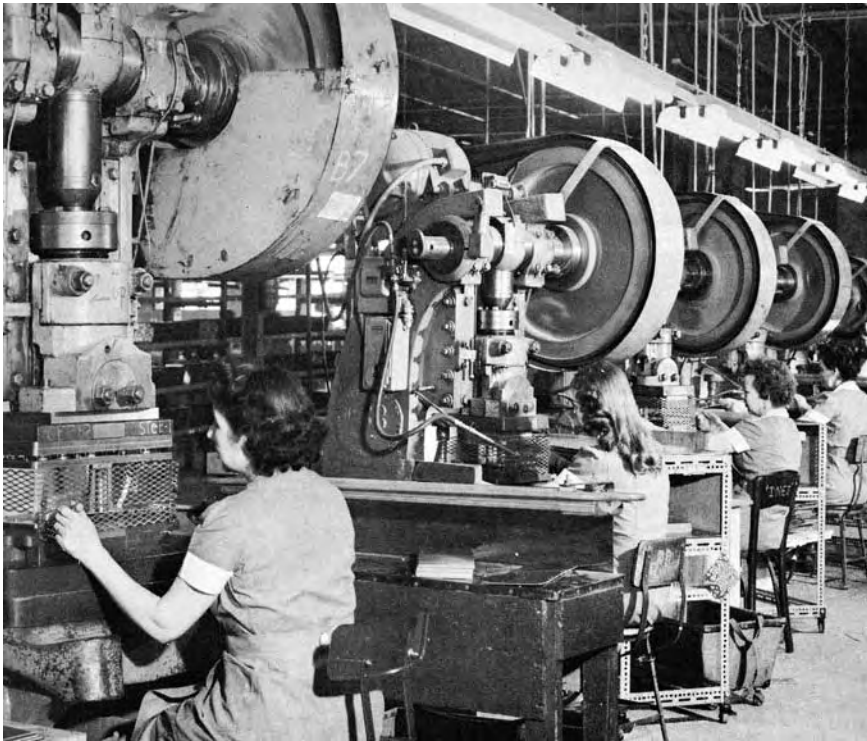

**Power presses for one-shot perforating and blanking of circuit panels used in high production application.**

A variation of the etching process using plated metal, which is impervious to the etching solution, for the resist is shown. Metals such as gold, silver, lead-tin alloys and a rhodium-nickel combination are frequently used as the resist.

Another variation of the etching process eliminates the necessity of using mechanical means such as eyelets, rivets, lugs, etc., for making front-to-back electrical connections on printed circuits. By the method outlined feed-through connections are accomplished by plating through holes. An interesting feature of this process is that cost does not increase in proportion to the number of holes. This method has many applications on computers, missiles, instruments, etc. An enlarged cross section of a plated through hole is shown.

Thermosetting laminates are most widely used as insulating materials; however, molded plastics, ceramics and glass base materials are also used. Individual printed circuit manufacturers can provide information on the particular advantages of the methods they employ.



**Silk-screened panels approach drying oven on conveyerized trolley.**



Plated-thru holes connect the many pads on opposite sides of this circuit panel.

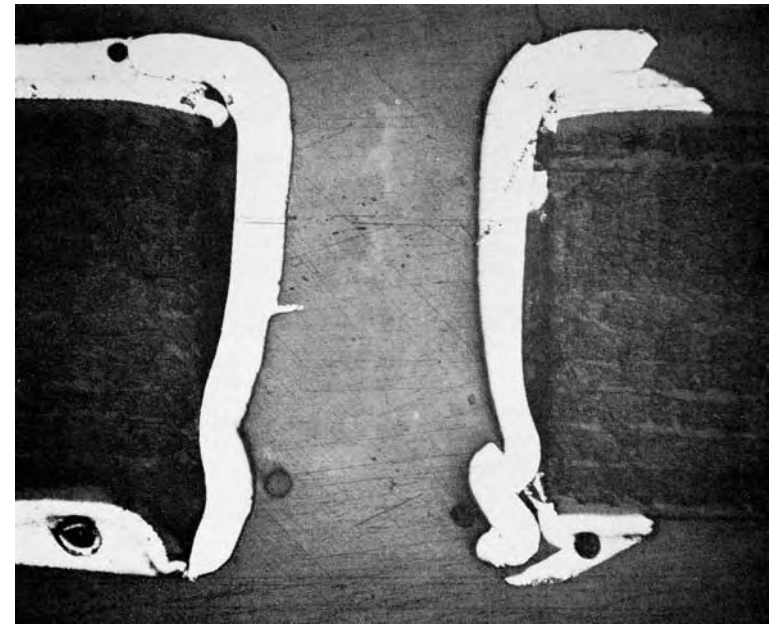

A. Improper eyelet shows poor crimping and unreliable solder fillet.

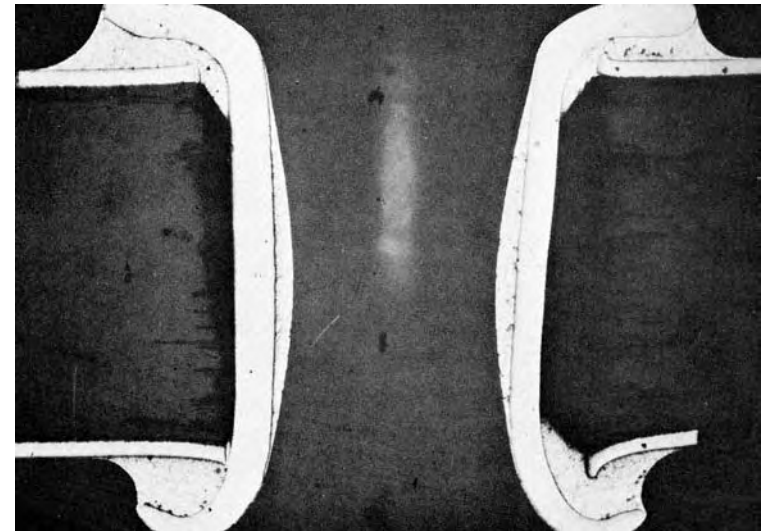

B. Proper eyelet shows good crimping and excellent solder fillet.

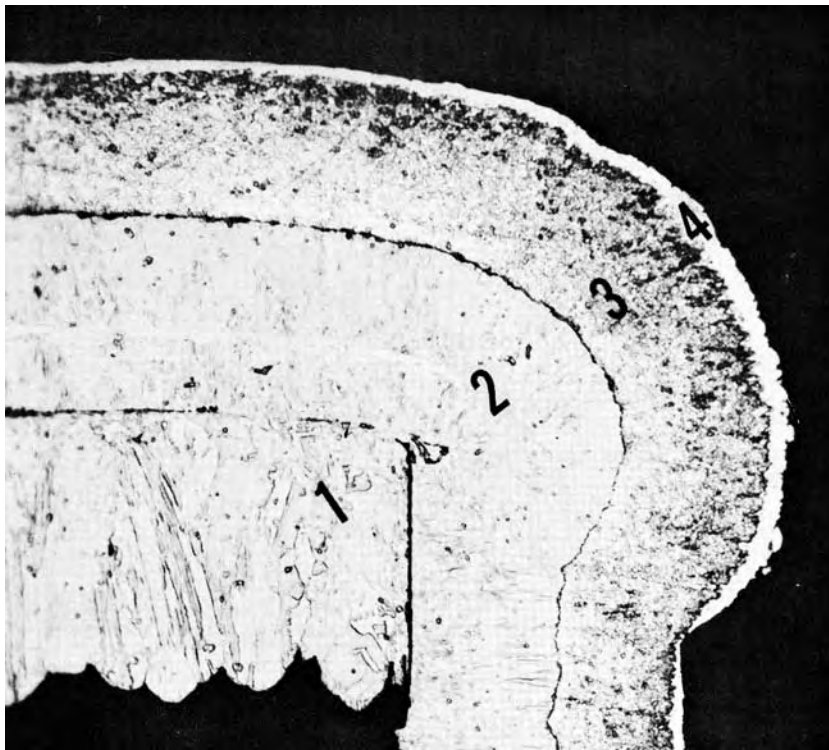

Enlarged corner of a cross-sectioned plated-through hole showing

1. the original copper cladding
2. copper plating
3. silver plating
4. gold plating

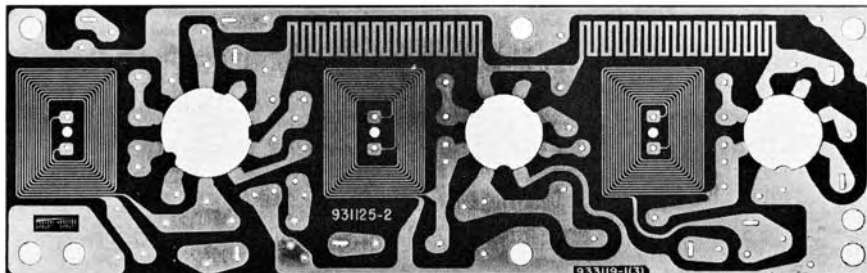

Intricate coil pattern incorporated on I.F. panel, produced to close "Q" tolerances.

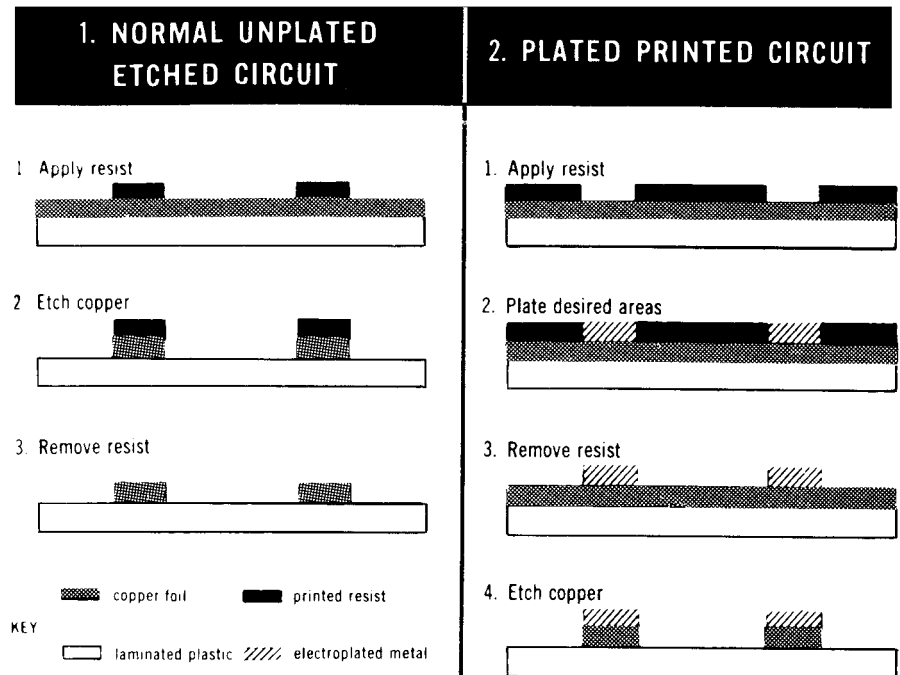
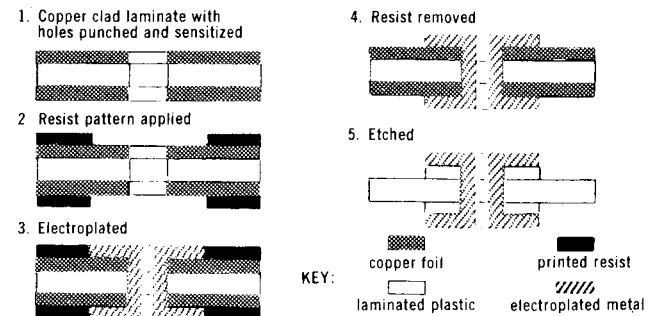

Illustration of processing steps for plated and unplated etched circuits.

### Step-by-step plated-through-hole process



There are three methods for establishing the original conductivity on the walls of the holes as illustrated in step No. 1.

1. Use of a liquid dispersion of graphite.
2. Use of a silver conducting ink or lacquer.
3. Chemical deposition of metal from a solution of the metallic salt.

Illustration of processing steps for plated through hole circuits.



## PROCESSING LIMITATIONS

Users may benefit from brief discussion of manufacturing problems, since there are still somewhat unusual control difficulties which affect the precision that can be reasonably expected of a circuit panel. In circuit fabrication ratio of inspection to production labor costs is frequently as high as two to one and process engineering overhead is magnified even more on complex designs. Thus, design and specification simplicity has considerable impact on cost and quality. It is possible on a laboratory basis to produce very elaborate circuits of almost unbelievable complexity and detail with respect to definition, multi-metal platings, well registered two-sided conductor patterns, embedded wires, etc.

However, the inherent problems of fabricability on a routine and high production basis are prone to undermine judgments based entirely on lab sample pieces, eventually burdening the job with higher costs than anticipated, an unreliable component, or the necessity of a rushed re-design simplification.

Elsewhere in this manual is information on standard printed circuit tolerances which can be provided without cost premiums. Below are mentioned in brief manner some of the considerations which necessitate such tolerances.

### Registration:

The location of pads and wiring with respect to holes is considerably more difficult than would be reasonably assumed because, in the more popular production techniques, silk or metal screens are normally employed. Since the process is limited by (1) reproduction inaccuracies and minor distortions which are expensive to control in screen process, (2) the fact that the equipment is inherently not as accurate as a sheet metal die, (3) the insulating materials, even cold punching grades, can be more satisfactorily fabricated at somewhat elevated temperatures and are subject to thermal distortion and rather substantial warp, and (4) the common use of multiple printing so that tolerances must be distributed over areas in many cases much larger than that of an individual board.

### Two Sided Circuitry:

Panels with two sides have been and will continue to be produced in sizeable quantities where there is no other feasible way to engineer the unit. Usually considerations other than size are involved, since component density is usually the limitation on miniaturization. Two sided panels necessitate duplicate reproduction and manufacturing operations in certain operations, and also theoretically double the inherent shrinkage rates for rejects.

### Hole Diameters:

Sheet laminates are subject to greater shrink factors than metals. When a heated strip of multiple circuits is progressed through a die, holes in the first units punched while at higher temperatures will shrink more than subsequent units which will be punched at lower temperatures. Chemical cleaning and plating operations performed after punching or drilling operations tend to produce further shrinkage and not always at uniform or entirely predictable rates.

### Hole Centers and Outer Blank Dimensions:

The shrink characteristics of insulating materials inject the same problems in control mentioned above. In addition, the fact that temperature distortions differ depending on the grain of the material adds further complications.

### Line Widths and Spacings:

Variations in conductor widths are produced by the tendency of a screened image to spread, since resist inks must be viscous enough to fill or flow in order to prevent pin holes and smooth out mesh delineations of the screen. Each silk screen impression, between cleanings of a screen, may be expected to have a slightly wider deposit.

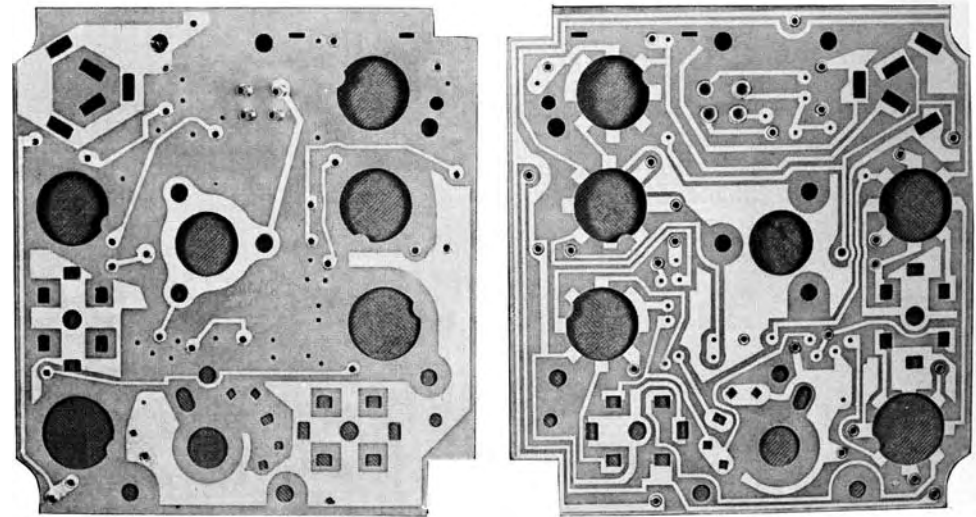

High density of circuitry necessitated two-sided panel design illustrated.

### Platings:

Electro deposited finishes inject problems in maintaining adhesion on base metals or conductive coatings greater than on metals because chemicals must be selected which will not affect the base laminates and adhesives employed. Since deposition usually follows lines of least resistance, thickness is subject to considerable variation. Plating must be done at slow speeds to prevent "burning" or "treeing". Finally, to maintain conductivity for electro-deposition, reverse printing is required which makes for difficult handling and plating tends to penetrate "resist masks more easily than etching, leaving flecks of unwanted plated metal between conductors and generally rougher definition of lines.



Conveyorized processing and inspection of etched circuit panels.

## LAYOUT AND DESIGN

### Initial Layout

The adaptation of a preconceived circuit schematic has its logical starting point in reducing wires to a pattern which can be applied to one or more flat surfaces, with the elimination of as many crossovers as possible. The designer, in considering these problems, must adapt the schematic of an electrical circuit while simultaneously evaluating relationships of all components and conductors to achieve the desired performance qualities. Initial layouts are usually accomplished by using templates to represent components and making repeated free hand point-to-point wiring diagrams until the number of crossed leads has been minimized. It is desirable where possible to place all conductors on one side of panel. In many instances insulated components such as resistors, capacitors, diodes, etc., can be placed in a position to bridge conductors. This will minimize the problems of cross-overs. Where conductor cross-overs cannot be accomplished by using components for bridging, the use of staple-type jumpers may be utilized. Where the number of cross-overs and the circuit density warrants, both sides of the board can be used for conductive patterns with interconnecting accomplished by plated holes, eyelets, terminals, etc.

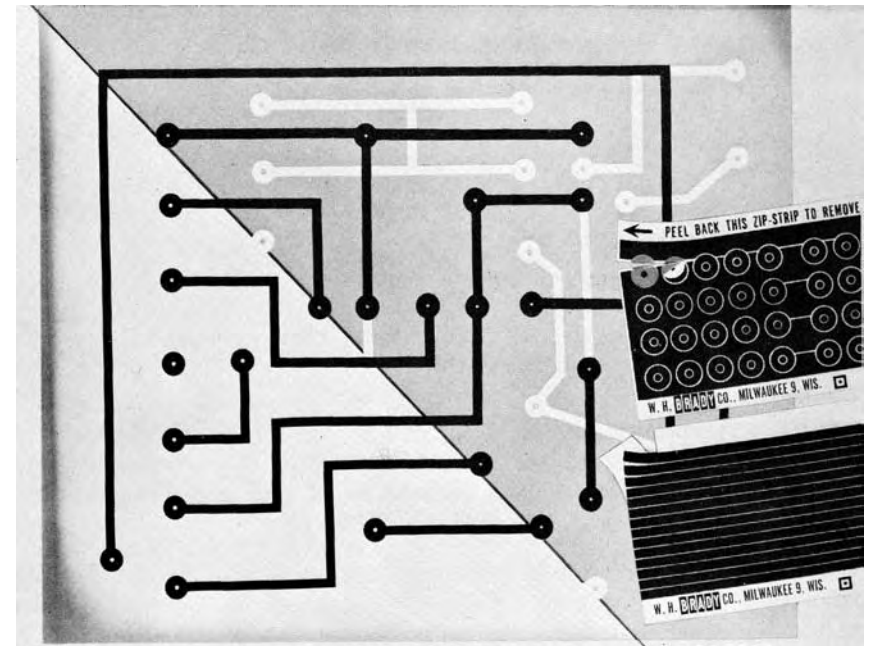

Commercially available die cut tapes and pads may be adhered to stiff board as a substitute for ink drawings where close tolerances are not required. Page 58 itemizes complete details on artwork masters.



**Drafting of master black and white printed conductor layout. Drawings should be several times actual size for best results in reproduction.**

Following the initial layout, the designer may wish to consider the insertion of additional metallic foil patterns for shielding, capacity, grounding, etc. The inherent problems of heat dissipation and conductor electrical/physical tolerances can receive consideration at this time. Somewhat more planning to provide grounding at convenient places may be necessary with printed circuits than with conventional metal chassis.

When the circuit schematic has been reduced to an arrangement conducive to printed circuit techniques, the size of conductors and the distance between them will merit consideration. Aside from the electrical considerations, the use of thin (0.00135") and wide conductors are advantageous in that they lend themselves to easier reproduction and lower unit costs, particularly when generous spacing between conductors can also be provided.

### Conductor Width

The best insurance against pits or pinholes in the conductor causing problems in current carrying capacity is a liberal factor of safety in conductor width. It is desirable to maintain minimum conductor widths of 1/16" wherever practical.

On the other hand a conductor width greater than 1/8" may cause problems in hand soldering because of excessive heat transfer, and in dip soldering because of uneven distribution of solder.

### APPROXIMATE CAPACITY PER UNIT LENGTH OF CONDUCTOR FOR VARIOUS BASE MATERIALS

Separation	CAPACITY MMF PER INCH				
	Phenolic XXXP	Phenolic XXP	Phenolic XP	Glass Bonded Melamine (Unsupported)	Teflon
1/32	1.05	0.88	0.79	1.25	0.33
1/16	0.85	0.71	0.64	1.10	0.26
1/8	0.72	0.60	0.54	0.90	0.22

Distributed capacity is particularly significant at higher frequencies and careful pattern layout may be necessary to shorten and shield R.F. conductors.

### TABLE OF RESISTANCES OF LIVE COPPER CONDUCTORS

Width of Line (inches)	Ohms Resistance per Linear Inch at 20°C*		
	0.00135" Thick Copper	0.003" Thick Copper	0.005" Thick Copper
1/100	0.050	0.023	0.014
1/64	0.032	0.015	0.0087
1/32	0.016	0.007	0.0043
3/64	0.011	0.005	0.0029
1/16	0.008	0.0035	0.0022
3/32	0.0054	0.0024	0.0015
1/10	0.0050	0.0022	0.0014
1/8	0.0040	0.0018	0.0011
5/32	0.0032	0.0015	0.0009
3/16	0.0027	0.0012	0.0007
1/4	0.0020	0.0009	0.00055
3/8	0.0013	0.0006	0.00037
1/2	0.0010	0.00045	0.00027
3/4	0.00067	0.00029	0.00018
1	0.00050	0.00023	0.000135

#### Resistance Per Square

$$\text{Formulae} \quad R = \frac{0.000503}{w} \quad R = \frac{0.000226}{w} \quad R = \frac{0.000135}{w}$$

Where R = ohms resistance per linear inch  
w = width of line in inches

\* Based on 100% conductivity of copper.

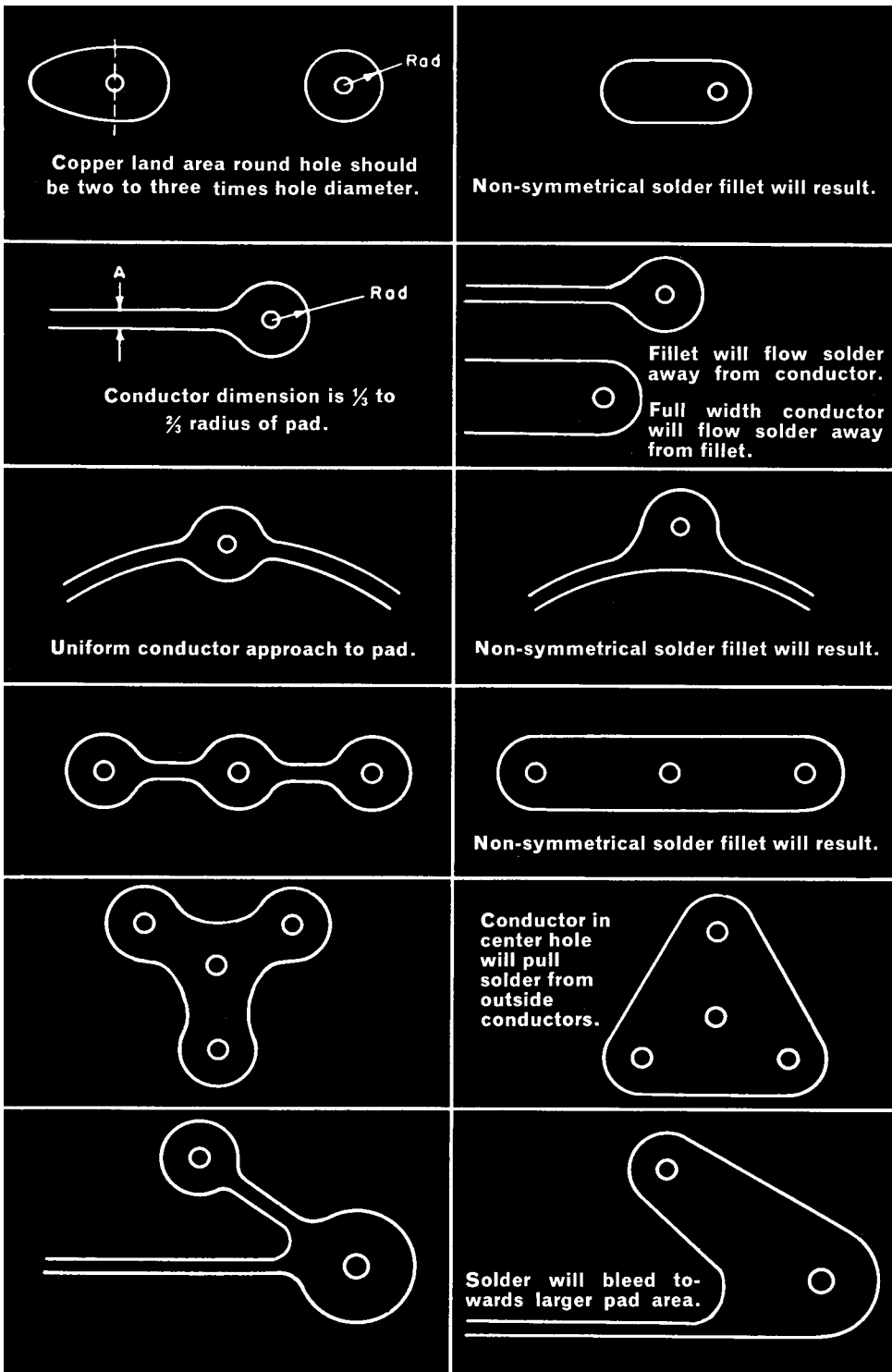

Configuration of land pattern greatly affects quality of solder joint. Preferred method is shown in left column.

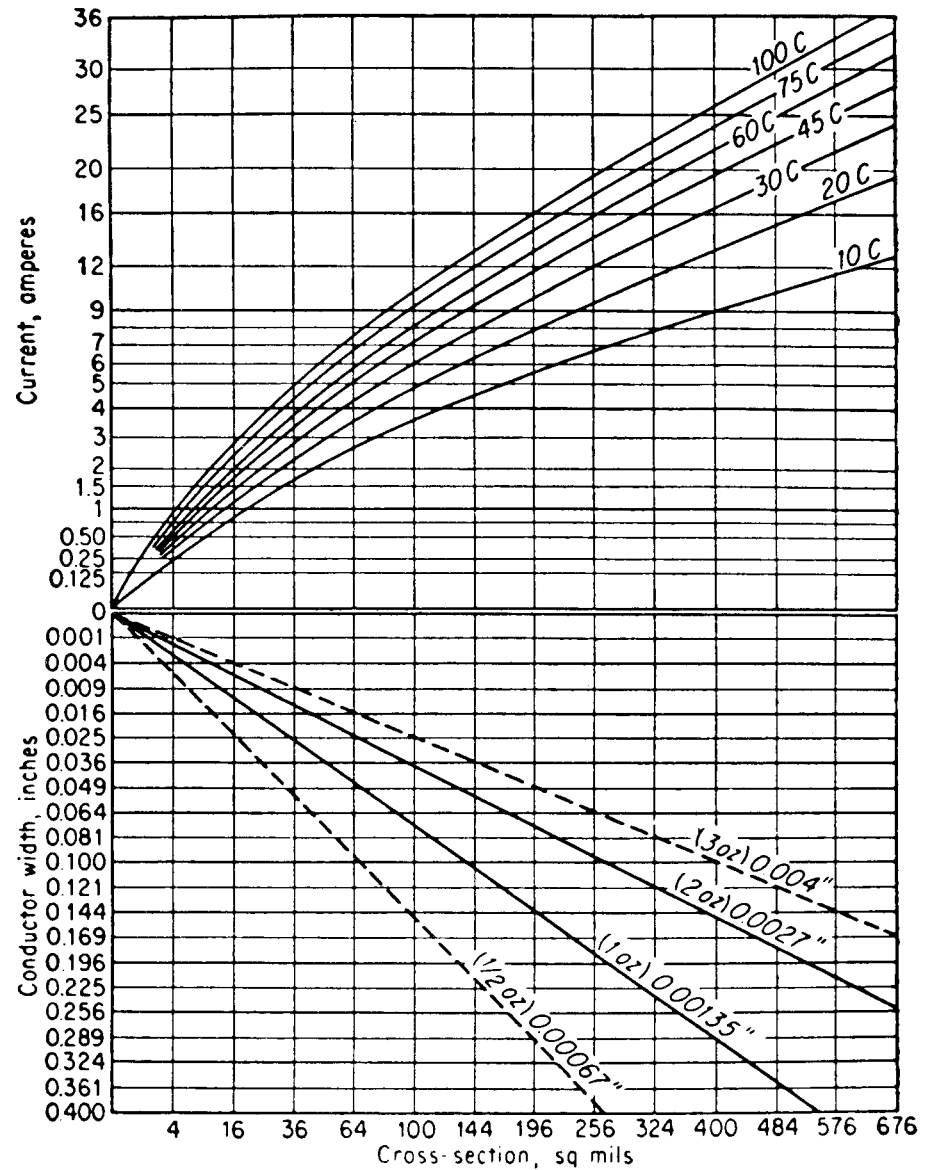

Design chart for use in determining current-carrying capacity and sizes of etched copper conductors for various temperature rises above ambient. The data is intended for use primarily with epoxy-glass materials and XXXP, but may be applied to other materials having equivalent bonds. The curves are derated a nominal 10 per cent to allow for variations in production techniques.

## Conductor Spacing

A minimum conductor spacing of  $1/16''$  is recommended, especially for dip soldering applications. Closely spaced parallel conductors are apt to cause solder "bridging" across the insulating gap during the soldering operation.

After the layout has been completed the master drawing (or artwork) is prepared.

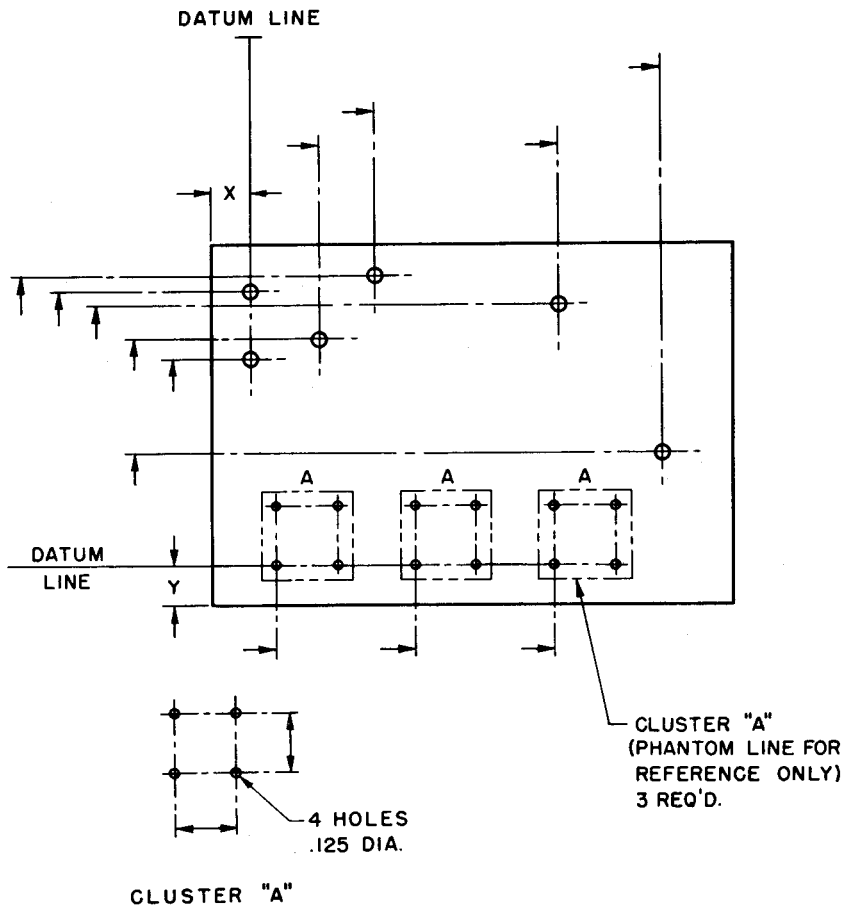

ALL SINGLE ARROW DIMENSIONS ORIGINATE FROM RESPECTIVE DATUM LINES.

An accepted method of dimensioning printed circuits using datum lines. Coordinate dimensions showing hole locations are often listed on a chart, together with the hole diameters, instead of above method for convenience of toolmakers and inspectors.

## Mechanical

From the mechanical standpoint, most engineering will start at adaptation of the unit to the overall size and shape of the package. Where cost is a factor, it is important to keep in mind that overall dimensions, i.e., the area of the printed circuit board effect a considerable relationship on cost and purchase price. Thus, while earlier statements point to wide conductors and generous spacing, it is still advantageous to keep overall area at a minimum, the case being a typical designer's problem in achieving the most advantageous course between several considerations.

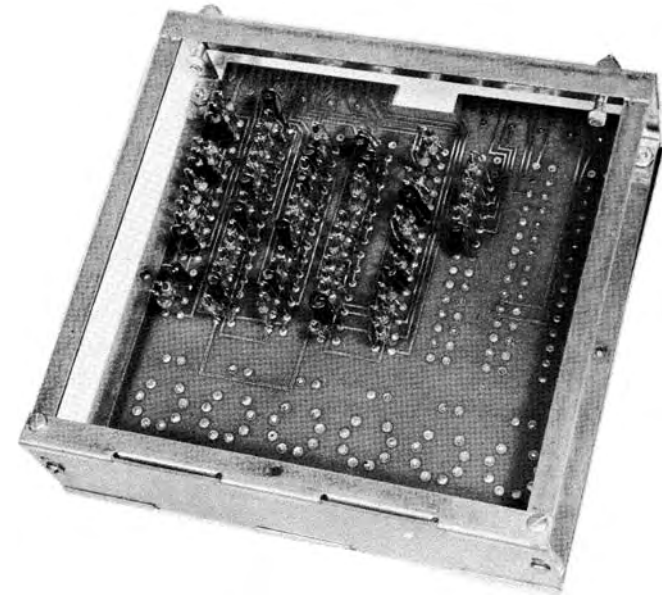

Sturdy chassis reinforcement contributes to reliability of this instrument application.

## Dimensional Considerations

Thickness of the base material is subject mainly to mechanical considerations of strength versus cost and fabricability. The most popular thickness used is  $1/16''$ . Thickness up to  $3/32''$  can be die fabricated in most materials and up to  $1/8''$  in some materials. One of the basic rules in piercing laminated plastics is that hole diameters shall be at least equal to stock thickness and spacing between holes should be one and one-half times the stock thickness. While holes as small as three-quarters or even two-thirds of the stock thickness are frequently pierced in some materials, the problem of broken punches and die maintenance increases as the hole diameter decreases.

Where the cost of drilling the holes can be tolerated the afore-mentioned recommendations need not apply.

It is good practice to make all plated hole diameters at least three-quarters of the stock thickness to ensure maximum reliability. Dimensions on plated holes should specify the finished hole diameter required after plating.

The accepted method of dimensioning a printed circuit is illustrated. Circuit hole locations can either be located by coordinated dimensions or spotted from the artwork. Refer to the chapter on Standards for tolerances which can be maintained by either method. Mounting holes are usually located by coordinate dimensions as are all other critical holes.

Sharp internal corners on slots and cutouts should be avoided wherever possible inasmuch as they may weaken the printed circuit as well as add to the fabricating cost.

On plug-in type printed circuits the overall thickness and tolerances should be specified and not the nominal material thickness otherwise the board may not fit into the connector.

#### **Designing for Tape Programmed Production of Printed Circuits**

Many printed circuits used in critical military applications and low quantity, high quality commercial applications require close tolerance methods of manufacturing, particularly for use with mechanical insertion of components. The quantity required frequently does not warrant piercing dies, and often the thickness and type of base material (such as glass-epoxy) rules in favor of drilling techniques for optimum quality.

Close tolerance drilling usually requires the use of a jig-bored template. The template is hardened or bushed if quantities of over 50 to 100 are required. The large variety of printed circuit hole patterns required in applications such as missiles and computers make the use of such templates expensive and time consuming.

One of the answers to the problem is numerically controlled drilling whereby the hole pattern can be tape programmed. The machine illustrated is a numerically controlled positioning table incorporating four to six drilling stations operating either simultaneously or in sequence. Holes are positioned to an accuracy of plus or minus .001" with a repeatability of plus or minus .0005". The input information is programmed on a 4" wide 32 channel Mylar tape as shown. Additions and deletions are made in a matter of minutes.

In addition to the obvious advantages of improved accuracy and increased reliability, it is possible to "tool up" quickly and inexpensively. In order to take maximum advantage of tape programmed fabrication, the designer should be cognizant of the following information:

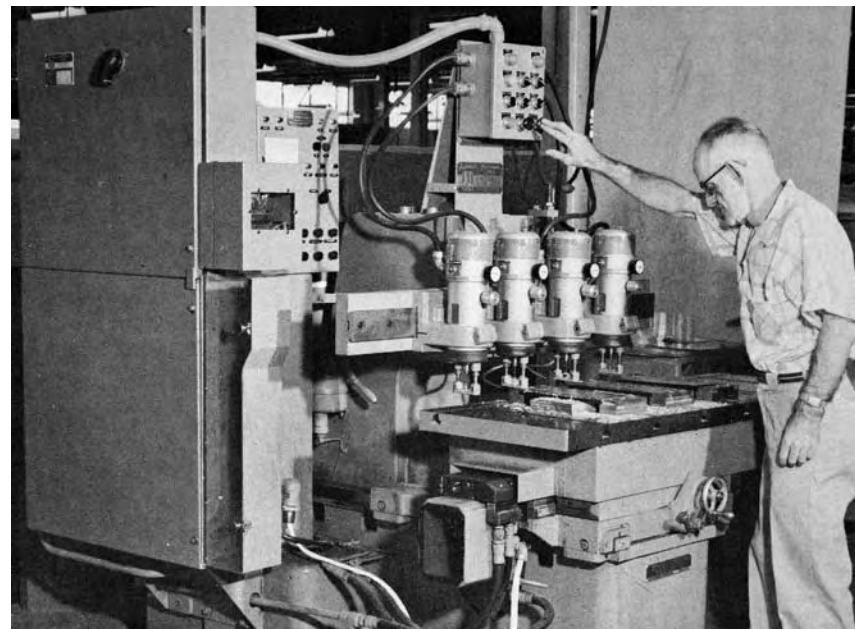

**Numerically controlled positioning table incorporates four to six drilling stations operating either simultaneously or in sequence.**

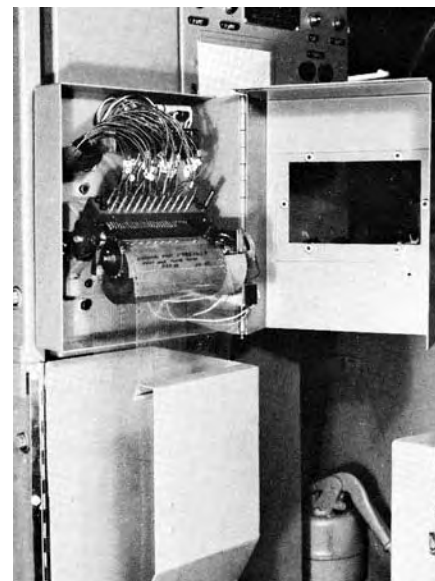

**Input information is programmed on a 4" wide 32 channel Mylar tape as shown.**



1. Since numerically controlled machines are infinitely variable, no grid system is required for hole locations. This allows more freedom in designing miniaturized equipment; however, the machine is equally adaptable where a grid system is used.
2. The number of different hole diameters should be kept to a minimum.
3. The use of small isolated land patterns or bosses which tend to lift during drilling should be avoided. This is true of any method of hole fabrication.
4. A coordinate plotting table or a grid glass, is recommended for spotting hole locations on artwork. Either method is faster and more accurate than conventional draftsman's scales. The coordinate plotting table is recommended especially where holes are located in a random pattern. The grid glass is acceptable for holes located in a grid pattern.
5. The numerically-controlled positioning table is designed to position holes referenced from a zero position as shown in Figure 3. It is important that fourth quadrant dimensioning be employed with the zero position representing the origin point of the fourth quadrant.

The aforementioned recommendations are also applicable to operations such as eyeletting, staking, piercing, etc., performed by tape programmed machines.

#### Size Considerations

The size of the printed panel is frequently determined by packaging or associated component considerations beyond control of the designer, but there are occasions where he can balance the economies, the reduced inter-panel connection problems, and simplified handling characteristics of a single large board against the possible advantages of unit replacement, flexibility and simplified mechanization of several smaller panels. Since only the raw material costs in printed circuits tend to remain constant on a per square inch basis, an unusually large piece may cost only one-half as much on an area basis as a very small piece. In larger pieces, however, the yield from the standard sheet laminate sizes is very important, and the designer would do well to consult with suppliers to obtain efficient overall dimensions.

The majority of computer and instrument applications employ many small interchangeable plug-in printed circuits as illustrated. In small boards utilization is more efficient and dimensions are not so critical. The small boards frequently plug into one or more larger boards which serve as interconnections.

It is easier to use multiple soldering techniques on small printed circuits.

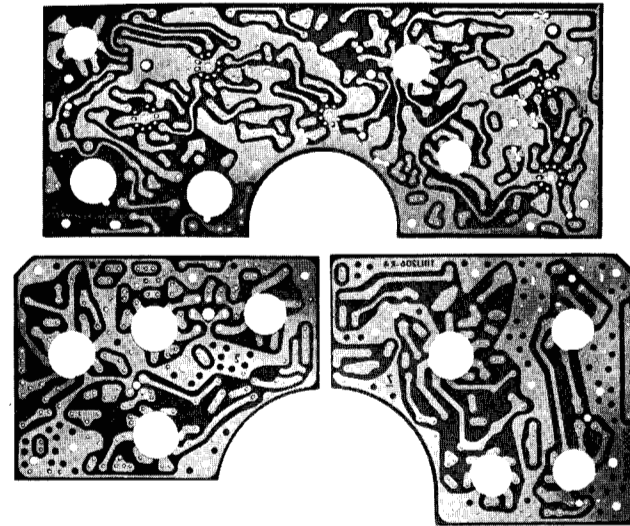
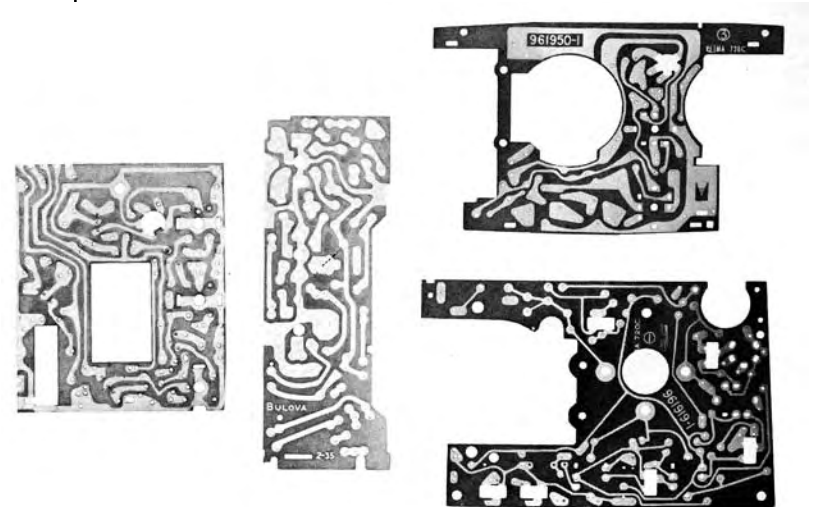

Illustration of panels comprising circuitry of 14 inch portable television set wherein two boards were redesigned into one unit with substantial economy resulting.

#### Component Layout and Mounting

Included in the considerations of mechanical design can be the question of mounting standard electrical or electronic components. Most manufacturers now have variations designed for printed circuit applications in such components as connectors, sockets, capacitors, transformers, coils, volume controls and terminals, as shown, and the designer may wish to obtain samples and recommended mounting drawings from contemplated sources.



These panels for transistor radios illustrate miniaturization possibilities and intricate punching possibilities.

## Current

The current carrying capacity of a conductor is limited by the amount of heat generated. If the maximum allowable temperature rise is known the line width can be determined from the curve shown. This curve plots the temperature rise for a given current in various size conductors.

In many applications the voltage drop is an important consideration. The graph should prove helpful to designs in which ground currents and filament operation are major factors.

## Leakage Resistance

Leakage resistance between printed conductors is influenced by the same variables that effect voltage breakdown. In addition, there are the variations in insulation resistance of the base laminate from one manufacturer to another, and from batch to batch, the leakage properties of fluxes used in dip soldering, and the characteristics of protective coatings used if any. In general, circuitry designed in accordance with the above mentioned voltage-spacing ratio will give no insulation resistance problems.

Plastics affect efficiency of the circuitry when capacitors or inductors are part of the circuit pattern. Where coils are used the Q is determined by the plastic on which they are printed. The paper-base phenolic laminates produce the lower efficiency coils where Q will be about 75 for a line .015" wide. Twice this value is obtainable when glass laminates are used. A factor as high as 200 has been measured at 25 megacycles in a coil where line width is 1/32".

The portion of the foil pattern considered at ground potential may be used to further the efficiency of a pattern. Large areas of foil left as part of the pattern may be utilized as shielding. Sensitive patterns may be shielded by running lines parallel on each side and connecting such lines to the ground pattern. In this way sensitive lines are enclosed or shielded from other parts of the circuit.

**NOTE:** Large areas of pattern may blister if a circuit is dip soldered. These areas should be broken by including voids or relief of lines or numbers.

## Fabrication Considerations

Design requirements for fabricating thermosetting laminates in other fields are applicable to printed circuit base materials. Miniaturization and automatic assembly have, however, contributed to the necessity for close-tolerance fabrication. Unnecessarily close tolerances will greatly increase the cost of production tools and raise rejection rates. If possible, the following recommended fabrication tolerances should be adhered to:

1. Pierced hole diameters should not be smaller than two thirds the thickness of the material.

2. Distance between pierced holes or between a hole and the edge of the card should be at least one and one-half times stock thickness.

Cold punching laminates are generally recommended where close tolerances are to be held. Dimensional variations in hot punching materials are due to unpredictable contraction and expansion. Shrinkage of hole diameters also takes place as the result of chemical etching, cleaning and plating operations.

## SWITCH PLATES & COMMUTATOR DISCS

Printed circuit techniques have been used to particularly great economic advantage in switch applications. Over the past years printed circuit switches have proven themselves in many diversified applications including binary converters, stepping switches, shaft read-out devices, programming and timing switches, telemetering switches and code discs, to mention a few. A variety of printed switches and commutators are shown.

The advantage of the printed technique is derived from the fact that the cost of printed circuit switches does not depend on the complexity of the switching function as is the case in all mechanical methods of manufacture. As a result printed circuit switches show up to the greatest economic advantage in complex switching applications.

In general, printed circuit switches fall into two categories:

1. Single or gang RAISED-pattern plates for low speed or, hand operated switching applications.
2. Single or gang FLUSH-pattern plates for high speed, or low torque, switching applications.

In designing a printed circuit switch the importance of the proper choice of materials cannot be overstressed. The primary factors which affect this choice and the overall switch design follow:

1. The speed of operation.
2. The number of operations required.
3. The characteristics of the load.
4. The accuracy required.
5. Any special mechanical consideration (size, torque, flatness, runout).
6. Any special environmental consideration (Temperature, humidity, vibration).
7. Electrical noise problems.



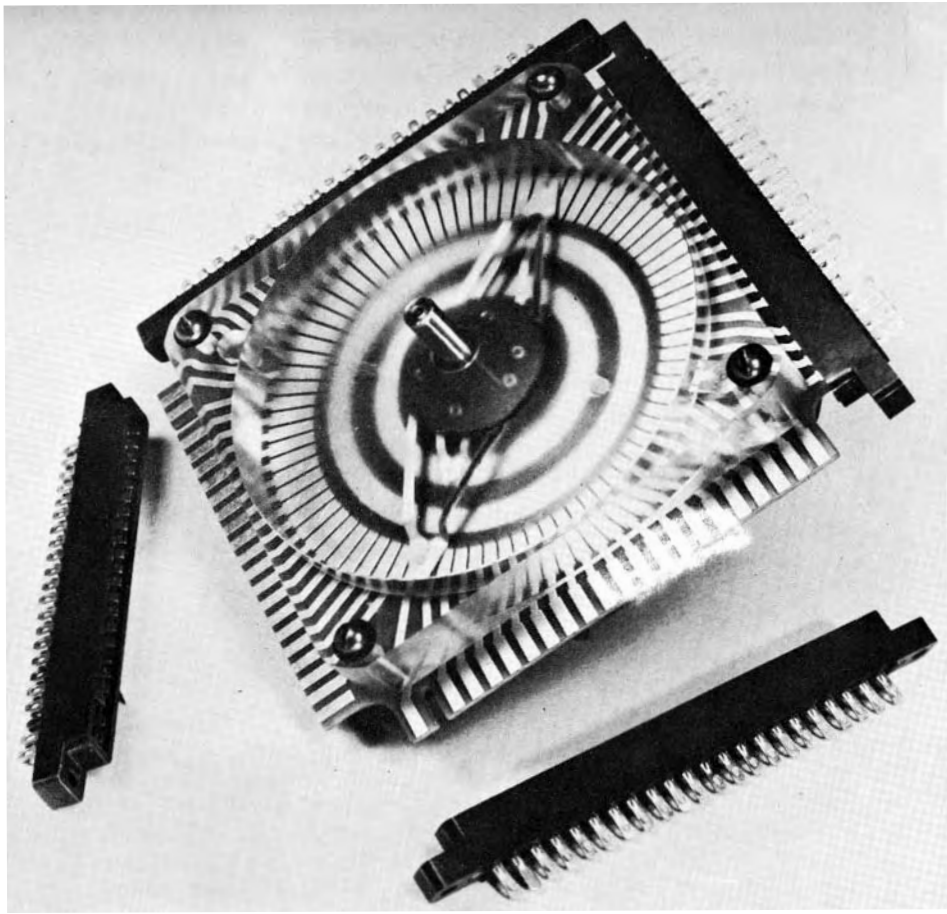

Rhodium nickel plated stepping switches.

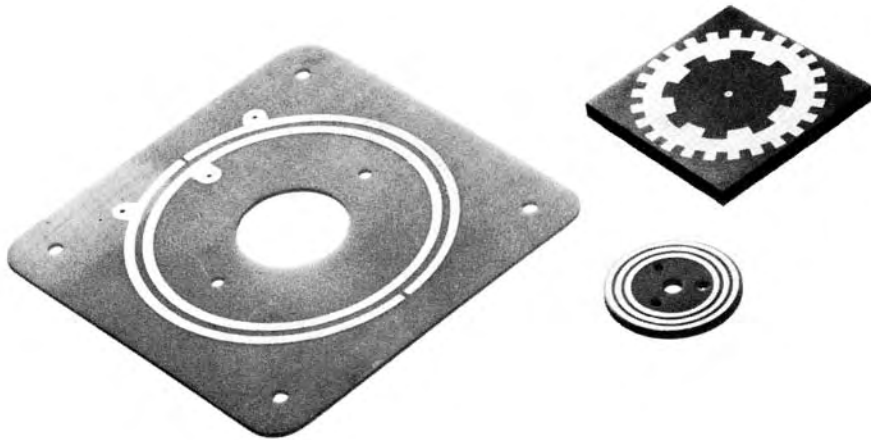

Printed circuit switches and commutators.

**CHARACTERISTICS OF PRINTED CIRCUIT SWITCH PLATES & COMMUTATOR DISCS**

CONDUCTOR PATTERN	PLATING	PLASTIC BASE	SPEED RANGE	REPORTED* LIFE RANGE IN REVOLUTIONS	TYPICAL APPLICATION
RAISED	.001" to .003" silver	Phenolic or Epoxy	Up to 300 rpm	Up to 1,000,000	Hand operated detent switches, high frequency switches
RAISED	.001" Nickel with .000020 to .000050" Rhodium	Phenolic or Epoxy	Up to 500 rpm	Up to 50,000,000	Servo mechanisms, commutators, slip rings, stepping switches
FLUSH	.0015" Nickel with .000020" to .000050 Rhodium	Flush Surface Melamine or Epoxy	Up to 2000 rpm	Upwards of 50,000,000	High speed, low torque, bounceless applications

BRUSH MATERIALS—Gold alloy contacts, silver-graphite contacts and plated phosphor-bronze brushes, when operated with contact pressures between 2 and 20 grams, give the most satisfactory wear resistance.

\*The reported life ranges listed are the results of tests on specific applications and should not be construed as being typical or average values for all applications.

Because of the many factors affecting the life range, it is difficult to report "average" values.

## SELECTION OF MATERIALS

The base material for printed metallic conductors in the predominantly used etched circuit process, is in most cases a laminated plastic, thermosetting in nature and not subject to cold flow, heat or temperature distortion. This dielectric generally consist of a paper or glass base material impregnated and coated with a resin binder under high heat and pressure to produce stiff solid sheets of good mechanical and electrical characteristics. Some applications of a special nature will employ a flexible fabric base material which can be rolled or folded.

The selection of materials to be used as the insulating base of pre-fabricated wiring boards depends naturally on the application. The importance of such electrical properties as power factor, dielectric strength, insulation resistance, moisture absorption and loss characteristics will be determined by the type of equipment in which the circuit will be employed, the spacing between conductors, normal operating temperature, humidity, etc. Mechanical characteristics such as machinability, punchability, flexural strength, impact strength, the tendency to craze or crack should also be examined.

### Foils

Electrolytic copper foil is used almost exclusively for all etched circuit applications because of its high conductivity, good solderability, low cost and ready availability in broad widths.

Rolled copper foil is available to some degree for applications requiring a finer finish than that obtainable when electrolytic foil is used.

Other foils such as silver, brass, aluminum, etc. also are available in narrower widths at greater cost. These are seldom used since copper can be plated with any of the commonly electroplatable metals at relatively low cost to give the foil any special surface properties which may be required.

The copper foil thicknesses most widely used are .00135" which weighs one ounce per square foot of area, and .0027" which weighs two ounces per square foot of area. The choice of copper thickness is usually made on the basis of the thinnest copper foil that will meet the current carrying requirements for any given circuit pattern. Other copper foil thicknesses are available for special applications.

### Plastics

All the commercial copper-clad plastic laminates are available in standard thicknesses of 1/64", 1/32", 3/64", 1/16", 3/32", 1/8", 3/16" and 1/4" as well as other thicknesses. Standard NEMA thickness tolerances usually

run about plus or minus 10% although closer tolerances are available at additional cost (See NEMA booklet, "Standards for Laminated Thermosetting Products").

### Copper-Clad Plastics Now in Use—Description and Application

PAPER BASE phenolic laminate grade XXXP is by far the most widely used of all base materials for etched circuits at present. This is due to its excellent electrical properties and relatively low cost. XXXP is approved and extensively used by the armed forces. For most general chassis printed wiring applications such as radio and TV, XXXP is recommended under the following conditions:

- a) Where the operating temperature requirements do not exceed 250 degrees Fahrenheit.
- b) Where the board will not be subjected to great impact, shock, or vibration.
- c) Where high frequencies or high impedance circuits do not dictate that a lower loss factor material is necessary.
- d) Where arcing will not be present (especially in switch applications).
- e) Where moisture absorption of 1% (24 hrs.) can be tolerated.
- f) Where flatness is not extremely critical.

Other phenolic grades, such as XP and XXP are available if cost is a factor, and lower electrical properties are acceptable. See table on Page 49.

All of the materials normally used in the manufacture of printed circuits made on the various bases of high pressure laminates can be blanked, punched, sheared, drilled, sanded and routed according to standard shop procedures.

EPOXY-GLASS and PAPER BASE laminates are becoming widely used for printed circuit boards and raised pattern switch applications that are too severe mechanically or electrically for XXXP. This material is available in flexible thicknesses of .006" and .010" as well as the standard rigid thicknesses. Epoxy-glass is relatively low in price compared to Silicone or Teflon, but has the greatest mechanical strength of all the materials discussed. This material is desirable when good insulation resistance, good heat resistance, low moisture absorption and excellent electrical requirements are demanded. It machines very easily even though it is a glass-based laminate. It compares roughly to Silicone-glass in electrical properties . . . with low loss factor, excellent arc resistance, low moisture absorption .

Epoxy-glass is recommended for most applications where XXXP is ruled out **provided** operating temperature does not exceed 325 degrees Fahrenheit, or where loss factor does not necessitate the use of Silicone or Teflon.

**SILICONE-IMPREGNATED GLASS** Grade G-7 has a slightly lower electrical loss factor than Epoxy-glass, slightly higher maximum operating temperature capacity, and greater electrical stability with temperature change. It is recommended only in applications where Epoxy is ruled out and Teflon-glass is considered too costly for the application, until such time as bond strengths and mechanical strength and fabricating characteristics are improved.

**FLUOROCARBON-GLASS** is electrically superior to any other foil-clad laminate now available. It withstands the highest maximum operating temperature and has fairly good bond strength. Its extremely high price has limited the use of this material to a very great extent. However, in cases where the operating temperature exceeds 340 degrees Fahrenheit or where frequencies are in the microwave range there is no other copper-clad material currently available that can be considered.

**Special Materials**

1. **MELAMINE SURFACED LAMINATE** is used extensively for flush pattern switch plates, slip rings and commutator discs, and has been found to be superior for many such applications. This material has a thick melamine resin surface (about .015") which gives the flush switch plate the maximum arc resistance (215 seconds) combined with extreme surface hardness. The core of the material may be changed depending on the application.

2. **PHENOLIC LAMINATES** other than those with paper base, such as linen, canvas, Orlon and Nylon cloth bases, are available. These are rarely used at present. Canvas and linen base phenolics have poorer electrical properties than XXXP but have improved strength and punchability. For details concerning these laminates consult the NEMA manual, "Standards for Laminated Thermo-setting Products."

**Warp and Twist**

Metal conductors and insulating bases have in general primarily different properties. As a result, single sided circuits become more susceptible to warping if they are unsupported by copper cladding on the reverse side.

<b>PAPER BASE PHENOLIC</b>	P	7	8	13,000	11,000	3.6%	.045	5.5	225°F.	Poor	<b>COMMENTS</b>	Used where elec. prop. are secondary. Good structurally, inexpensive.				
	7	8	14,000	12,000	1.8%	.040	5.0	225°F.	Poor							
<b>PAPER BASE PHENOLIC</b>	XXXPC	7	8	12,000	10,500	0.7%	.030	4.6	250°F.	Poor	Most widely used elec. grade. Best all around type. Excellent punchability (cold).					
<b>EPOXY PAPER FLAME RETARDANT</b>	NA	7	8	18,000	15,000	0.5%	.030	4.0	250°F.	Good						
<b>EPOXY FIBERGLASS</b>	G-10	7	9	55,000	45,000	0.35%	.020	4.3	325°F.	Very Good	Self-extinguishing. Good dimensional stability, good solvent and alkaline plating solution resistance, good punchability.					
<b>FIBERGLASS</b>	G-11	7	9	55,000	45,000	0.35%	.020	4.3	375°F.	Very Good						
<b>SILICONE FIBERGLASS</b>	G-7	3	4	20,000	18,000	0.55%	.015	4.0	400°F.	Very Good	As above, better mechanical char. at high temperature, poorer mechanical ability. Good ARC resistance. Difficult to process. Good temperature resistance.					
<b>FLUORO-CARBON FIBERGLASS</b>	NA	3	4	8,000	5,000	0.2%	.001	2.5	400°F.	Very Good						

**CHARACTERISTICS OF COPPER-FACED LAMINATES (TYPICAL)**

## SELECTION OF COMPONENTS

Selection of components naturally has its initial basis in the usual quality, performance, availability, interchangeability, and size characteristics with which the experienced designer is quite familiar. In utilization of prefabricated wiring, the engineer has further evaluation to make in selecting parts whose configuration and termination points lend themselves to the most advantageous use of multiple soldering techniques.

### Components with "Pig Tail" Leads

The leads of resistors and paper condensers can be formed through small holes, and standard types lend themselves to ideal adaptation to prefabricated conductor patterns. Available combinations of resistors and condensers, long a pioneer application of printed circuitry, have leads lending themselves to multiple soldering techniques in a manner similar to the individual components. Ceramic disc capacitors which wedge into slots in the panel are now utilized in a number of commercial television applications.

The actual assembly can be by threading leads through holes of diameters .008 to .012" larger than nominal for the wire gauge and giving same a slight bend as they are cut with a 1/16" to 1/8" extension. Another approach is indicated in jig forming and cutting leads to appropriate dimension before inserting. Development of standardized spacings for the forming of leads of various types of components and values thereof lends itself to the practical elimination of any possibility of error in placement of components, although presenting additional problems to the circuit designer.

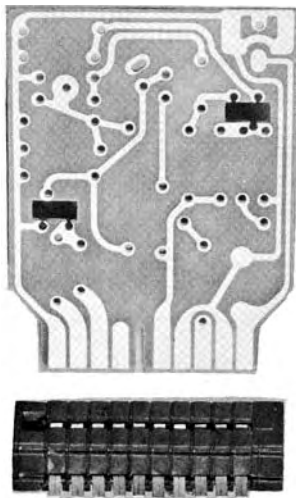

Card receptacle illustrated receives plug-in circuit board with parallel terminals brought to the edge of panel.

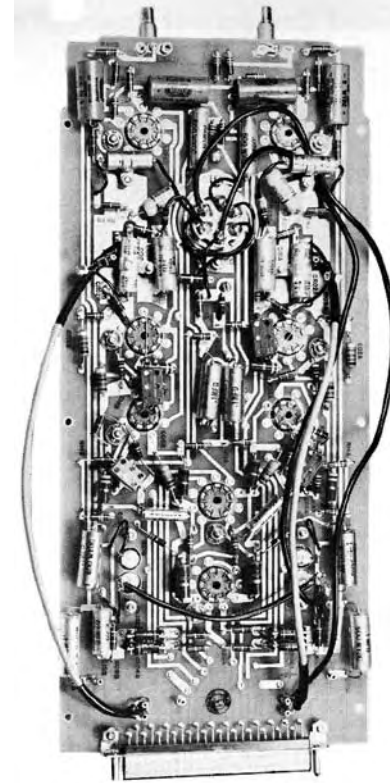

Plug-in board utilizing right angle type printed circuit connector.

### Printed Circuit Connectors

Connecting a printed circuit to an electronic system of which it is a part may be done through the use of printed circuit connectors. The connectors are generally molded, rectangular in shape and offer a multiplicity of connecting terminals on a single strip. Points of the printed circuit to be joined to the connector are brought out to one or more edges of the board in regularly spaced parallel lines. The board becomes a plug in element and is pushed into the connector where it is held by the spring force of the contacts.

Another type of connector used widely is the right-angle unit. The connector is dip soldered directly to the printed circuit. The contacts protrude from the connector at right angles and then into the board. This type of connection is available for taper pin termination.

The above are used largely in instrument or industrial type equipments. For appliance and other commercial applications, edge connectors made from metal stampings and terminal lugs are used at connection points where it is expected that connections may be soldered or unsoldered a number of times. These prevent lifting of the foil at such points.

## Advantages of Special Component Basings For Coils and Tubes

Coil bases have been developed by several manufacturers to fit in with dip solder techniques. Since some standard types of oscillator coils have leads which are fragile and comparatively difficult to incorporate with circuit panels, the new bases with spring type leads off an insulating base, which integrate with printed conductors, are quite attractive from the manufacturing standpoint, although presenting some cost penalty.

The problem of satisfactory incorporation of tubes into circuit boards was long an obstacle to utilization of prefabricated wiring. The development of standard miniature, noval, and octal sockets has paved the way for rapid commercialization of dip soldering by providing units available in high production quantities. Socket terminals snap into holes in the circuit panel and provide mechanical spring contact with conductor patterns.

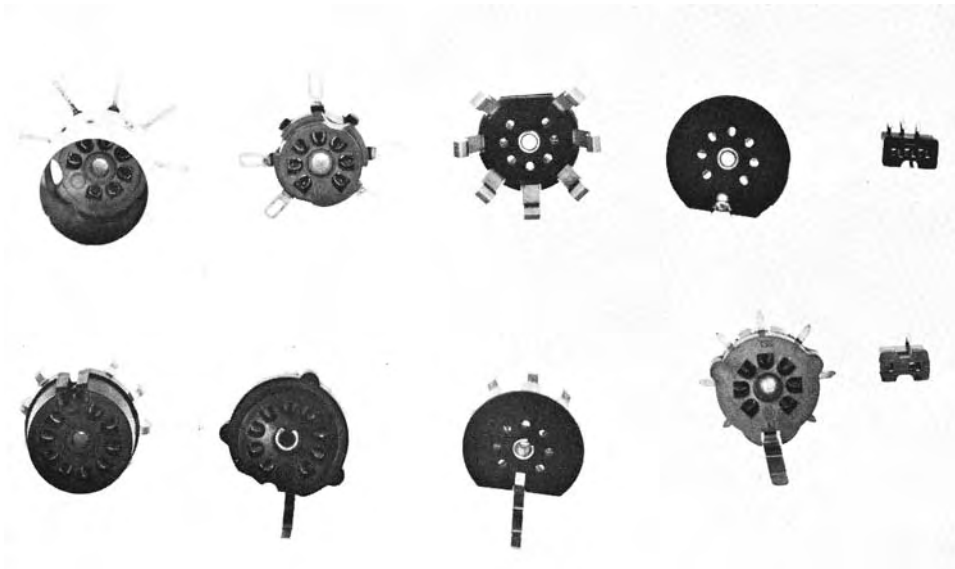

Some of tube sockets especially designed for dip solder attachment to printed circuit panels.

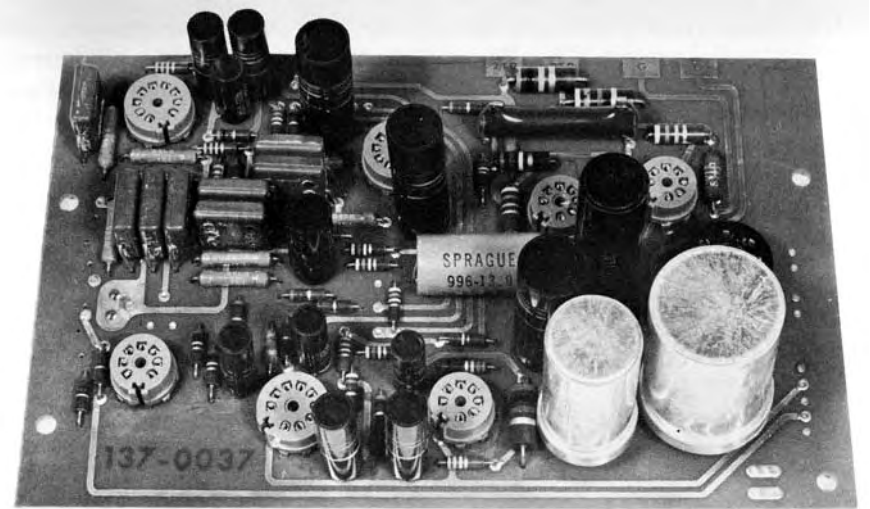

Another example of components designed for printed circuit use.

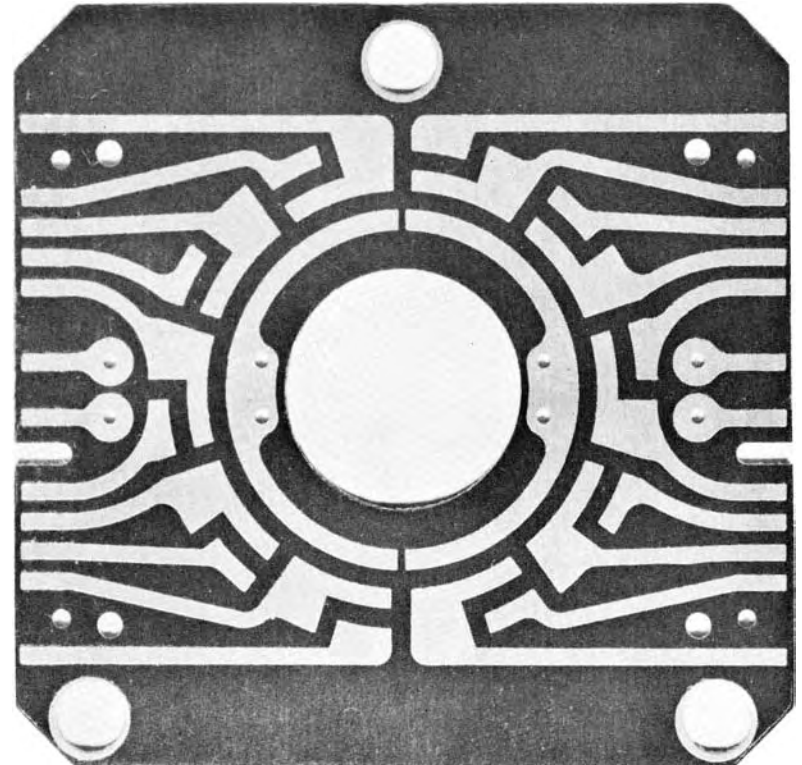

Rhodium nickel plated switch with printed connector terminals at each end.

The usual commercial intermediate frequency transformers have standardized base configurations with relatively straight stiff terminations desirable for rapid insertion and dip solder. Special variations have recently been introduced with spring grip terminals which offer the important features of providing mechanical support for "electrical" solder connections. Some applications indicate the desirability of a true "plug-in" I.F. type; this development would require present coil form bases to be modified by the use of a base with pins which could plug into a modification of a standard tube socket or other receptacle. The possibilities of superior reliability and easier servicing in such an arrangement are obvious.

Several manufacturers of potentiometers have modified volume controls to fit the general problems of printed wiring. Similar work is in process on the part of manufacturers of variable condensers, with efforts underway to provide units which can be dip soldered to the circuit panel.

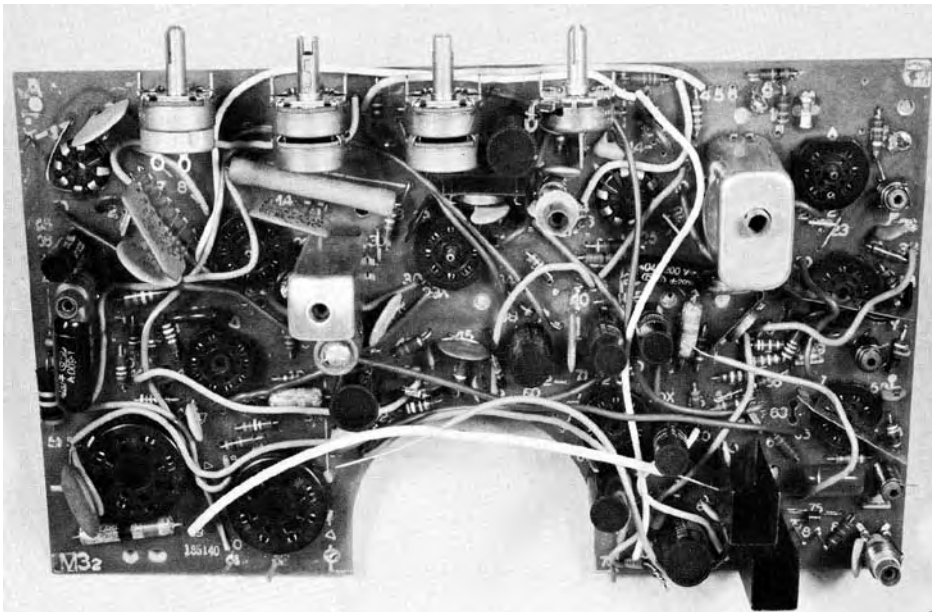

**Special plug-in volume controls, tube sockets, transformers, coils, stand up condensers and RC networks visible on this TV panel illustrate the availability of specialized components of many types for dip solder assembly to printed circuit boards.**

Electrolytic condensers can be incorporated by simply inserting the standard terminal spacings and dip soldering to the assembly. The newer development of snap-in and plug-in types has brought improved reliability and reduced line repairs resulting from the broad tolerances on standard basings. The rapid snow-balling of commercial applications suggest further development to competitive advantage and fairly rapid amortization of tooling costs necessary to change long established standards.

At least one manufacturer of speakers has development work in progress on units for inexpensive radio application which will snap into printed wiring boards for dip solder application of same. The successful consummation of this difficult project will indicate that virtually any component can eventually be engineered for the new art.

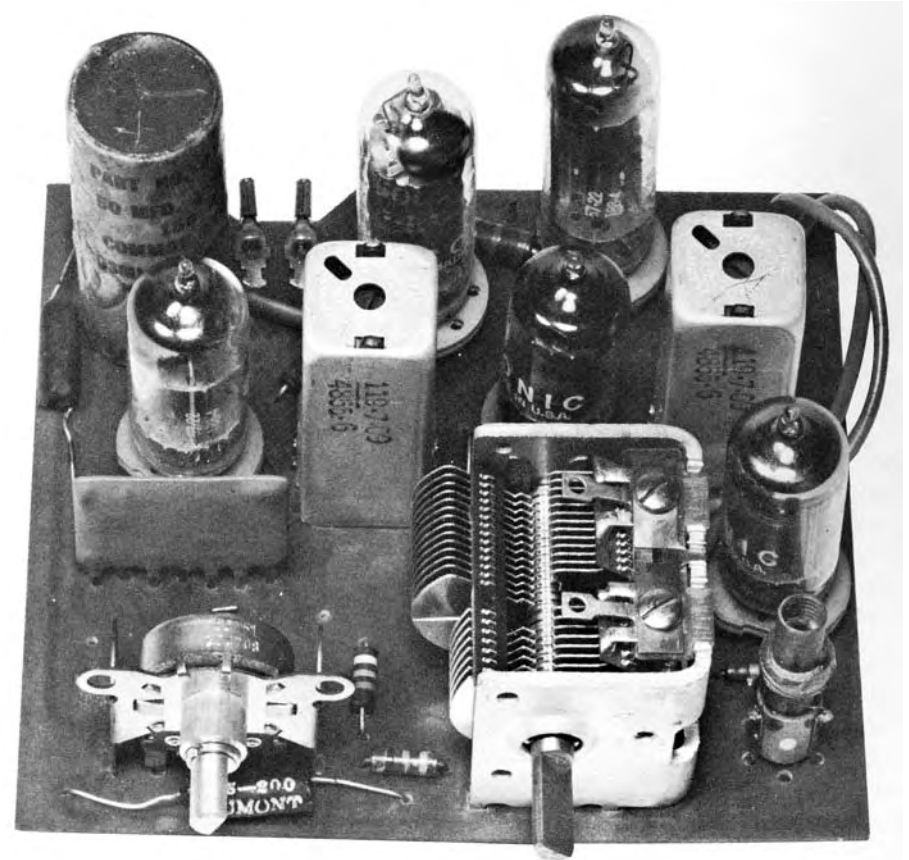

**The 5 tube receiver shown above is an excellent example of components such as tuning condensers, potentiometers, tube sockets, transformers and coils designed for printed circuit applications.**



### Component Applications of "Printed Circuitry"

Use of "printed" I.F. coils in the low inductance ranges where space permits sufficient turns constitute one of the most interesting developments of this art and can be readily adapted by dip solder joining of the terminations with appropriately spaced mating conductors on the circuit board. In some constructions a projection on the coil board is mortised into a matching slot in the major circuit panel.

The utilization of etched or printed circuit techniques in switches and commutators is an obvious application of the art.

High life expectancies are possible with proper plating on foils and close control of pressures with economy in cost and size a strong probability.

Multiple connectors with the combined features of low contact resistance, long life, easy connect and disconnect characteristics and utilizing mating etched circuit panels constitute an interesting application now under rapidly growing usage. Connectors of this type are characterized by contacting surfaces spread over considerable area to assure conductivity, are relatively inexpensive, and feature easy application of one of the mating elements to a conductor pattern on the circuit board proper.

Many television tuners now employ etched switch plates or component boards, and after false starts several years back, the success of applications assures further employment.

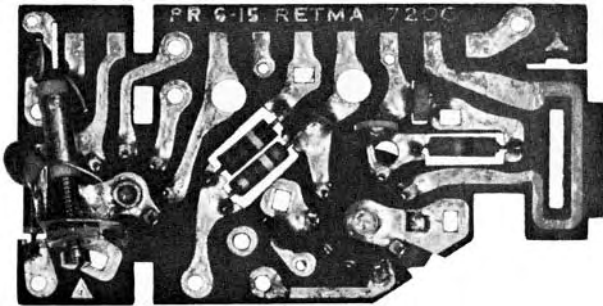

**Printed tuner plate assembly used in high production TV applications.**

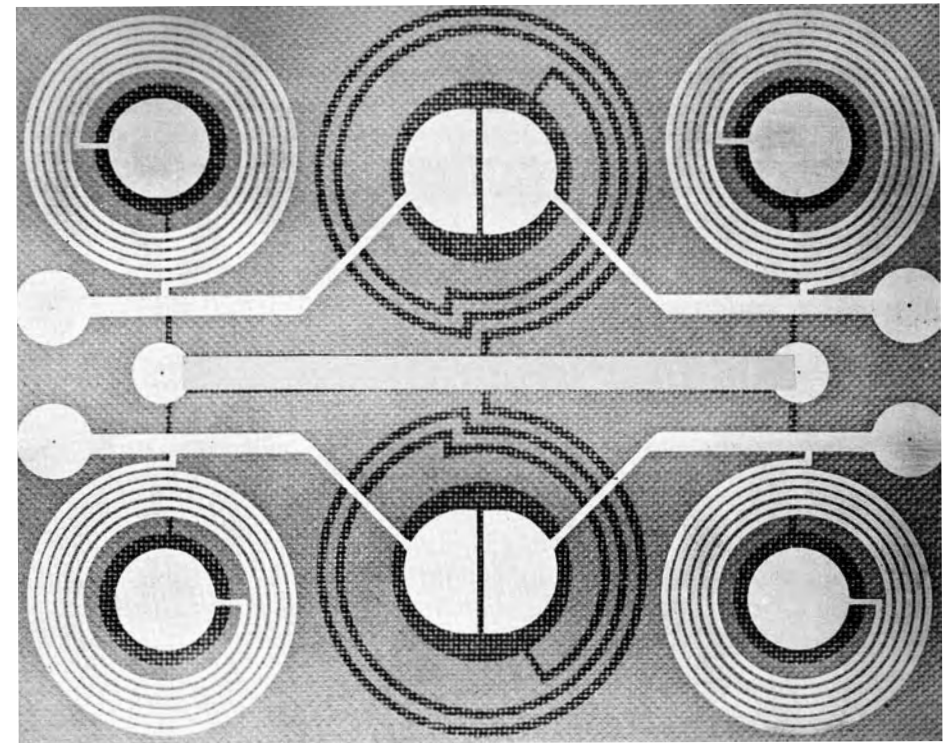

**Low value capacitors and inductors can be incorporated in the conductor pattern as shown in T.V. wave trap above.**

Recent developments of packaged circuit components have aroused considerable interest. The Bureau of Standards so-called "Tinkertoy" module employs stacked ceramic wafers with printed on capacitors and resistors connected by riser wires which plug into an etched circuit board. Similarly, several component manufacturers are producing resistor capacitor networks on a single steatite plate with leads or terminals along one edge which are inserted in the panel.

A more recent development employs up to seven more or less conventional tubular capacitors and carbon resistors, without leads, with ends which engage in fuse-clip-like terminals. Mounted in rows on a small etched circuit approximately 3/4" wide by 2-1/2" long, the unit except for plug-in terminals is resin dipped. The flexibility provided by the possibilities of varying the etched interconnecting circuit panel and the many combinations of values combines with the reliability of the standard type components and readily mechanized assembly to afford attractive possibilities in cost and quality.

## ARTWORK

Practically all of the manufacturing processes employed in production of printed wiring originate from a black and white drawing suitable for photographic reproduction. Although crude samples have been made from actual size heavy dark pencil layouts, it is well to keep in mind that the final product can be no better than the reproduction characteristics of the artwork.

Artwork is usually made from 2 to 8 times the actual size of the finished circuits. The scale used will depend on the tolerances required in the finished circuit and the reducing capacity of the camera used in making the negative.

A photographic reference dimension should be included on the artwork. It is desirable to use a datum line as a reference dimension. The reference dimension should be located within the board. Quite often self-adhering black tape conductor lines and bosses are used instead of inking. One of the advantages of taped artwork is the ability to make rapid changes of layout. Tape should not be used on critical applications unless the artwork can be photographed immediately after completion. Taped artwork is not as stable as inked artwork and has a tendency to creep.

In preparing artwork, allowances must be made for variations in the printed circuit manufacturing process and a careful study of the chapter on Standards is recommended. A large percentage of the problems on printed circuit designs can be traced to faulty artwork. It is well to observe the following recommendations:

1. Artwork should be made on a stable base material not appreciably affected by extremes of temperature or humidity. Mylar base material is recommended.
2. Artwork should be at least twice size, preferably 4 to 8 times size; however, it should not exceed 42" in length or width.
3. Hole centers which are to be etched out and used as drilling or spotting guides should be designated by a white dot in the center of the black land pattern such that the final (true) size of the dot will be approximately .020" diameter when the master is reduced.  
AVOID CROSS HAIRS.
4. Be sure to add a photographic reference dimension to the artwork.
5. Keep your smallest line width and/or spacing .031" or greater. .062" is preferred.
6. Keep your land pattern around each hole at least .031" in width. (The diameter of the land pattern should be at least 1/16" larger than the hole size when reduced.)

7. Break up large pattern areas on the side to be dip soldered if the overall area is more than 1/2" x 1/2" to prevent uneven distribution of the solder and blistering of the base material.
8. End results will be more satisfactory if your artwork is an inked drawing and the edges of the lines are clean and sharp.
9. For a two sided part your front master should register with your back master precisely. Close registration can be accomplished by establishing the centers of land patterns on both the front master and the back master at the same time by pricking through both sheets of film with a sharp instrument.
10. A land pattern on both sides of the master for plated through holes is recommended.
11. Check your master for dimensional accuracy. The largest allowable error should be no greater than one-half the allowable tolerance on the finished part when the master is reduced to final size; i.e., if a land is located within plus or minus 1/64" the master may have a maximum error of .007" when reduced. If a land is located plus or minus .005" no error on the master should be greater than plus or minus .0025" when reduced. Precision layout tools must usually be used. The average draftsman's scale is inaccurate for close tolerance masters. Vernier layout tables are commercially available.
12. Your nomenclature master should allow at least .031" between any inked nomenclature and etched conductor when reduced.
13. Avoid sharp corners on your conductor paths. Blending them with a radius is the best. A fillet between conductors and lands is also good practice.
14. If feasible, master drawings should be shipped flat. If not, rolled is satisfactory. Never fold them.



## FINISHES

On many applications it is desirable to cover the copper conductors with a protective lacquer, flux, solder resist or metal finish. The optimum finish depends on requirements for solderability, corrosion resistance, wear resistance, storage life, etc. While the following chart will serve as a guide, it is desirable to consult with the printed circuit supplier before finalizing specifications on finishes for specific applications.

Extensive research has proven that under certain conditions of humidity and D.C. potential, silver has a tendency to migrate across the base material over an extended period of time. It is recommended that the use of silver be avoided on any application where conditions which are conducive to harmful migration may be encountered.

FINISH	APPLICATION
Electroplated Solder, 60% Tin—40% Lead, .0005" to .002"	Excellent soldering aid, medium storage life.
Electroplated Gold, .0001" to .0002"	Excellent soldering aid, long storage life, excellent corrosion resistance, good non-wiping contact surface.
Electroplated Gold, flash immersion	Good soldering aid, short storage life, fair corrosion resistance.
Electroplated Nickel-Gold, .00025" to .0005" Nickel Plus .00002" to .00005" Gold	Excellent soldering aid, long storage life, excellent corrosion resistance, good contact wiping surface.
Silver, flash immersion	Recommended only where a silver finish is desirable for appearance.
Electroplated Silver, .0001" to .002"	Good switch and commutator contact surface for medium wear applications, good soldering aid, fair storage life, good corrosion resistance.
Electroplated Silver-Rhodium, .0002" to .0005" Silver plus .00001" to .00004" Rhodium	Good switch and commutator contact surface for medium wear applications. Excellent corrosion resistance, fair solderability.
Electroplated Nickel-Rhodium, .0002" to .0005" Nickel plus .00001" to .00004" Rhodium	Excellent switch and commutator contact surface, excellent corrosion resistance, excellent storage life, poor solderability.
Lacquer, Water Dip	Used to improve storage life of copper and plated surfaces.
Lacquer, Solder resist	Used to prevent solder from adhering to unwanted areas during dipping operation. Usually a thermosetting resin material it provides greater heat and humidity resistance, may facilitate better filling of lead holes.
Flux coating, Solder	A Rosin-Alcohol base coating applied on the printed circuit. Eliminates the fluxing operation prior to dip soldering.

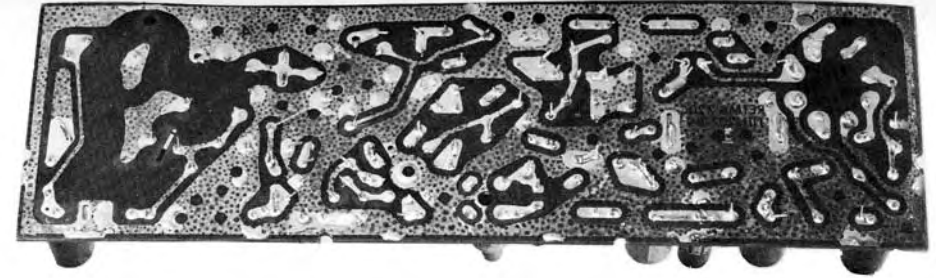

Panel with solder-resist mask after dip soldering of termination areas only.

## UNDERWRITERS LABORATORY APPROVAL

In order to be listed under the Underwriters Laboratory's acceptance code it is necessary that printed circuits manufactured on material specified be submitted to a series of tests. In granting approval for a given operating temperature printed circuits are subject to 56 days of conditioning under heat and humidity. Tests are made on bond strength as well as electrical characteristics. A separate submission is required for each laminators material. The purpose of the test is to determine whether a particular laminate manufacturer's material when processed by the printed circuit manufacturer submitting, is acceptable.

Briefly, the testing procedure is as follows:

1. Actual circuitry samples with various width conductors are subjected to dip soldering and simulated dip soldering. Bond tests are made of each sample.
2. Three samples are placed in air oven at 128 degrees Centigrade for 1344 consecutive hours.
3. Three more samples are placed in relative humidity of 83.5 to 86.5% at 33.5 degrees Centigrade for 1344 consecutive hours.
4. Three remaining samples are placed first in air oven for 168 hours, then in humidity for 168 hours, and the cycle repeated for a total of 1344 hours.
5. At conclusion, all samples are brought to room temperature and bond-tested.
6. Samples are subjected to arcing and dielectric strength tests as well as fire hazard tests.

## PRINTED CIRCUIT ASSEMBLY

The most elementary system of assembling electronic components to a printed circuit is to bend the leads of the components and insert them through holes in the printed wiring board, hand solder the connections between the component pigtail lead and the printed conductor, and then cut off the excess lead ends. Although the use of a printed circuit in this manner may result in some saving of assembly labor, much of the possible saving is lost by this hand soldering technique. In addition, some of the variables that plague users of the conventional point to point system are not eliminated since cold solder joints and rosin joints may still occur.

The majority of printed circuit assemblies, even in small production quantities, are dip soldered. Dip soldering, in addition to saving labor, results in greater reliability since the variables of time and temperature in the soldering operation can be closely controlled. The problem in assembly therefore, is to mount the components on the printed wiring boards so that reliable solder joints between their terminations and the printed conductors will be formed in the dip-soldering operation. Many components are now commercially available with specially modified terminals designed to snap into slots or holes in the printed wiring chassis.

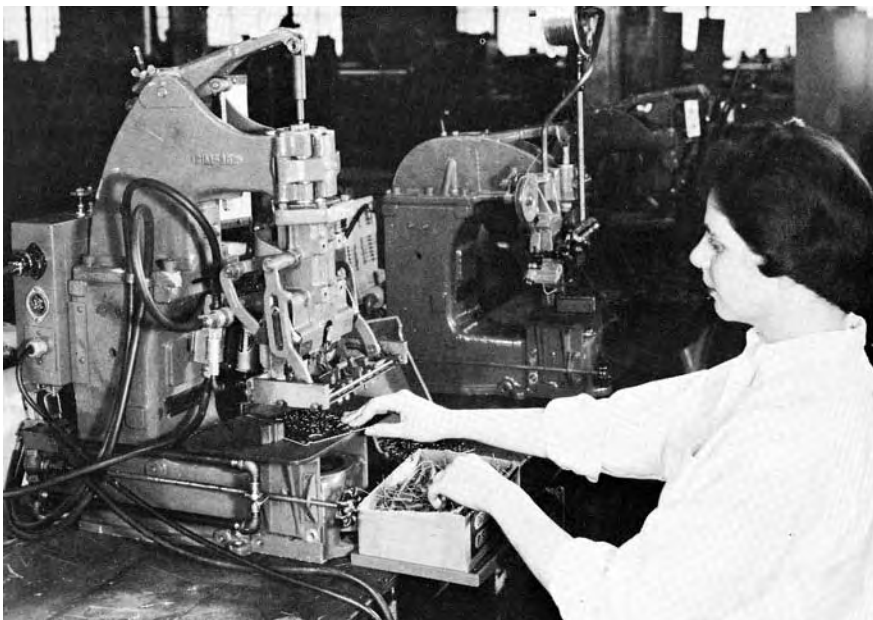

**Bench machine for forming and inserting components is a logical compromise between manual and conveyORIZED assembly.**

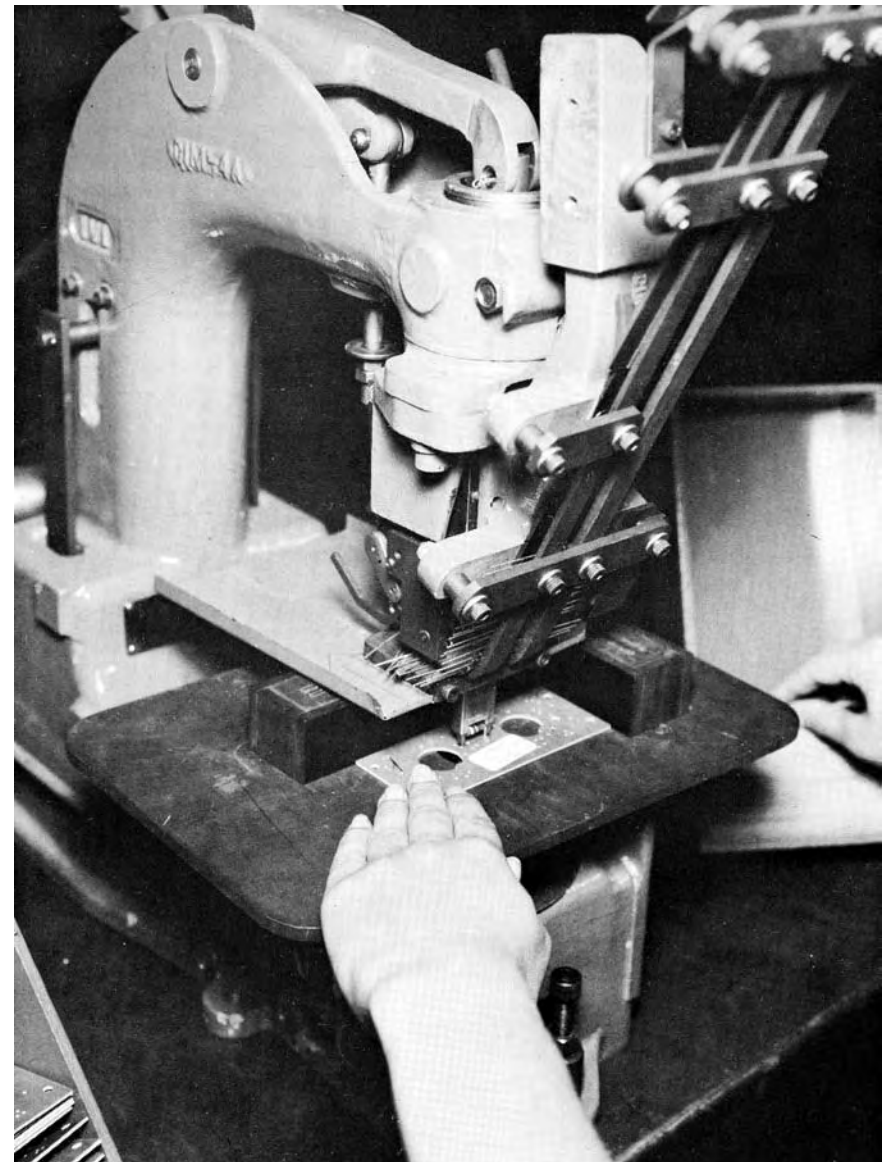

**The Component Inserting Machine used here as a bench unit is extremely versatile. It will insert axial lead components ranging from tiny diodes to large heavy-bodied capacitors and can accommodate tubular, rectangular or irregularly shaped bodies. Up to 700 insertions per hour can be obtained.**

Generally all conventional components are mounted on the side of the circuit board opposite the pattern so that they are not immersed in the solder during the dipping operation. In the case of two-sided circuits the components are mounted on the side opposite the one to be dipped. If components are to be mounted on the dip side they must be assembled after dipping and soldered in place by hand. However, components may be assembled by dip-soldering to both sides of the board provided their leads are brought near an edge of the board. Rather than placing the board flat upon the molten solder the edge may be dipped just far enough to make the joints.

Where a wire or a component must be soldered and unsoldered from a printed conductor a great many times during the useful life of the assembly, it is desirable to use an eyelet or some sort of terminal lug at the printed conductor termination. Although solder joints between component leads and printed conductors can be made and remade several times without damage to the printed wiring, care must be exercised. The use of an eyelet or a solder lug provides an added safety factor where unskilled maintenance personnel are involved.

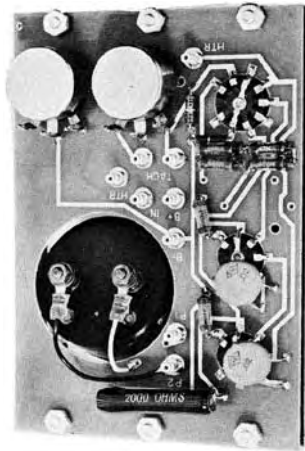

**Hand soldered assembly.**

The simplest method of inserting an axial lead component such as a resistor in a circuit card is to bend the leads at the proper distance, push the leads through the proper holes, bend them over on the reverse side to prevent the components falling out, and cut off the excess length of wire. This method is suitable where small numbers of assemblies are involved, but it consumes too much time for large scale assembly.

Pre-forming and pre-cutting of axial lead components is a widely used means of greatly increasing the speed and efficiency of the assembly of printed circuit boards. Machines are available which will cut the leads to the proper length and form them to the desired configuration at a high rate of speed.

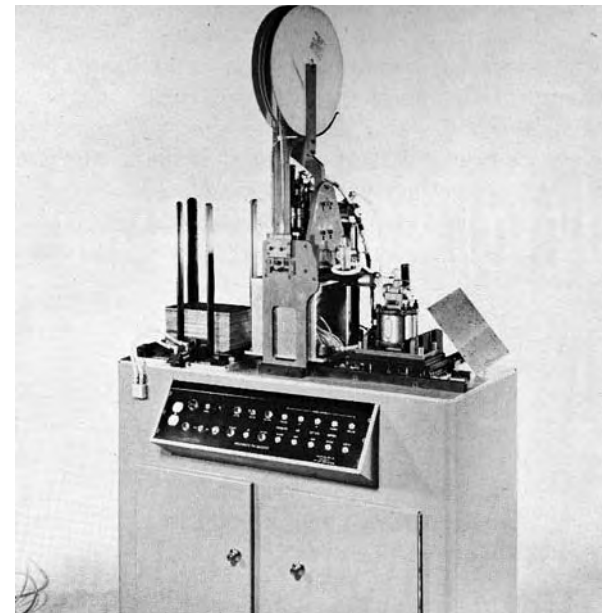

**Two types of machines for automatic terminal and lug insertion in high production TV panel manufacture.**

## AUTOMATION

Since the first commercial utilizations of printed wiring a few years ago, development of automatic and semi-automatic production equipment has proceeded at a remarkable pace. Several electronic manufacturers have developed their own conveyORIZED production lines employing multiple inserting heads to handle the various components. Equipment manufacturers have already produced a substantial number of units which are performing successfully in the field.

Components with straight axial leads such as resistors and terminal hardware, because of their high usage and relative ease of handling, have found the widest use of mechanized assembly, but machines for inserting sockets, disc capacitors, I.F. transformers, etc., are available also. The mechanized lines usually turn out assembled or partially assembled circuit panels at rates of 500 to 1,000 per hour and have been well engineered to provide for rapid changeover and maximum reliability. The machines have exhibited considerable ability to adapt to the relatively broad tolerances necessary in fabrication of sheet phenolics. The complexities of inserting 40 or 50 components automatically nevertheless indicate that debugging and maintenance are not trivial matters.

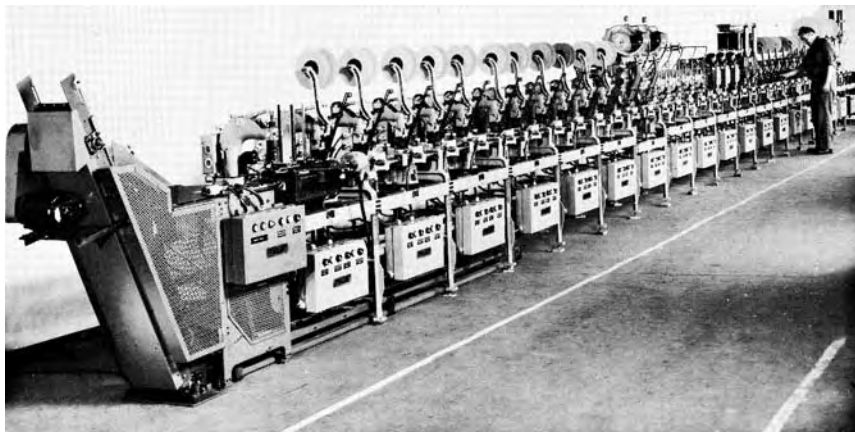

**A 38 station completely automatic assembly conveyor. This system has automatic pallet return, a board loading machine and various machine stations for feeding and inserting small, medium and large size axial lead resistors and capacitors, diodes, tube sockets, disc capacitors, R-C networks, eyelet terminals and jumper wires.**

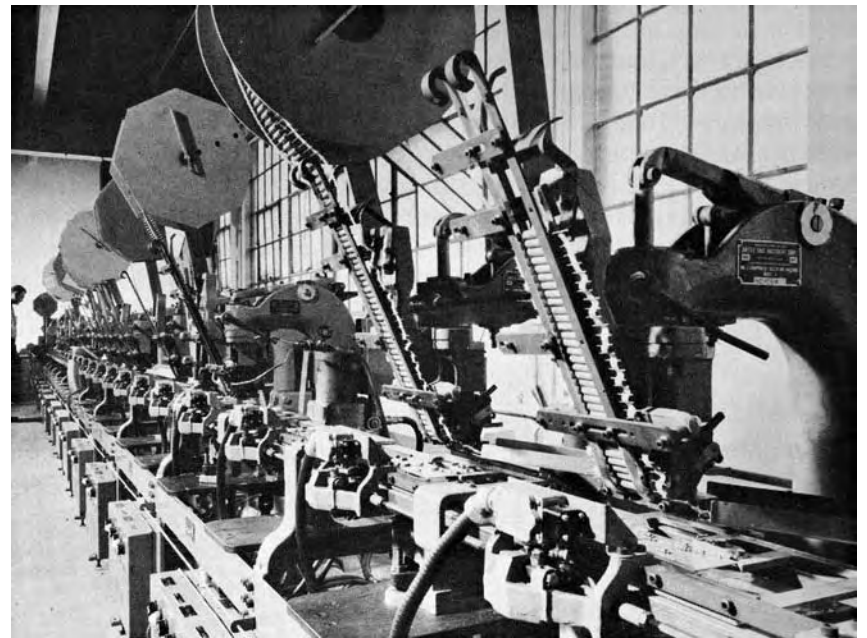

**In this type of assembly conveyor the printed circuits are carried on pallets which ensure exact positioning and reliability. Pallets can be designed with spring clips to hold several boards, making it readily adaptable for a variety of board sizes and circuit designs.**

In addition to the mechanized line approach, there are individual inserting heads available for such components and several types of machines available for lead cutting and forming preparatory to hand insertion. As additional types of components are redesigned for automatic insertion, the advantages of automation become more apparent.

The capital expense of a mechanized line plus the rapid changes in component design have to date ruled out the use of automatic equipment for most small volume applications, but printed circuits have also been employed to almost equal advantage using hand insertion means with ingenious assembly aids such as have been used in the older hand wiring methods. One large television producer, without using mechanized component insertion but with well planned employment of manual assembly aided by good fixture design has been able to make a 100 per cent production increase in a factory area that was previously more crowded when hand wiring and soldering was used.

The conveying of chassis down a production line may be accomplished with the various types of movable belts, chains, or slide tracks common to the industry. Jigs may be developed to preform and precut leads and terminals on components, if this type of preparatory operation is desired, such jigs being frequently employed in standard types of air or electric presses. Similar manual presses may be employed to insert tube sockets. More elaborate equipment with hopper feeds and automatic or semi-automatic loading provisions represents greater refinement in this phase. Eyelet machines, rivet machines and power screwdrivers, standard equipment in the electronic industry, may be used for attaching feed-throughs where double sided circuitry is employed, as well as the conventional fastening operations. As previously stated, components can be successfully inserted without special preparation and leads and lugs cut where required after assembly.

The uniformity of printed circuits suggests possibilities of rapid electrical test implemented by jigs built up with multiple test prods. Spring loaded conducting points mounted in fixtures and frames permit ready contact with fixed terminal and conductor locations with appreciable savings in time in locating shorts, cold joints, etc. Trouble diagnosis and line repairs are expedited considerably.

While there are definitely possibilities in progression to the "automatic factory" concept by use of printed circuits, the user will require only a very nominal investment in equipment and tooling to enjoy the advantages of product uniformity and cost reduction possible with the concept. When a hundred or more solder connections can be made by a one or two shot multiple soldering operation in five to fifteen seconds with the simplest equipment, it is obvious that very substantial labor savings will be accomplished by the initial step alone. Subsequent steps in mechanization will require larger proportionate investments in installations of a specialized nature and the law of diminishing returns will apply as cost savings are balanced against development costs and capital expenditures.

## MULTIPLE SOLDERING TECHNIQUES

Some of the greatest probabilities for cost advantage and most annoying production problems with printed circuitry have existed in the application of multiple soldering techniques. At this writing, there is considerable research activity into the science of multiple soldering and progress in materials and methods are being made which will result in further economies. The best proved and most widely used methods are basic ramifications of a solder dipping operation. Many manufacturers of solder and flux have published bulletins and detailed data on this subject.

With the rapid increase in the production of printed circuits, the original method of hand "spanking" one circuit at a time into the solder pot is fast giving way to more automatic methods. The use of belt devices to carry circuits into the pot, automatic "sweeping" machines, and solder pots actuated electrically to come up to the circuit, are some of the techniques now in widespread use.

Area or spot soldering is another basic technique. Flutes or cups are mounted within the solder bath and are actuated electrically to come up from the middle of the solder pot and engage only the areas where solder-take is desired. Where whole circuits are soldered by this means, larger dishes or "boats" are used. This technique offers the advantage of bringing solder of more uniform temperature to the circuit, and results in improved appearance of the circuit, less bridging, and a savings in the amount of solder used. The agitation of the solder by the up and down movement of the flutes keeps the temperature of the solder uniform throughout the pot and helps prevent oxides from forming at the surface.

### Materials Required

The minimum equipment needed for dip soldering is as follows:

- a. A solder pot of suitable dimensions for the work in view and a means of controlling the temperature of the solder in the pot.
- b. Solder (usually 60% tin, 40% lead).
- c. A recommended flux (the selection of the proper flux is most important)!
- d. Suitable clamp for holding the work.
- e. A flux-removing liquid cleaner if flux is to be removed.

Whatever technique of soldering is used, a most important question has to do with the temperature of the solder bath. Since the same board from a given manufacturer may vary in bond strength of the laminate, warping or peeling of the copper-clad from the base board may be encountered. Also, the temperature of the pot and the length of time of



immersion may affect the electrical quality of condensers, transistors and other components. Careful attention should therefore be given to the following factors:

- Size of the solder pot
- Temperature control of the pot
- Size of the circuit and rate of soldering
- The alloy to be used
- Removal of oxides from the surface of the pot

When cold circuits and components are dipped into the pot the temperature is lowered. The size of the circuit (heat absorption) and the number dipped per hour will have a given effect on the temperature of the pot. For this reason in selecting a solder pot it is a good rule to choose one that is too large rather than one that is merely adequate. When a larger pot is used the added metal acts as a heat reservoir, stabilizing the temperature of the bath. The pot should also have a control to regulate temperature accurately.

To minimize the difference between the temperature of the circuit and the solder pot, it is good practice to install a bank of infra-red lights between the fluxing station and the soldering station. Temperatures in the bank should range from 175 degrees to 250 degrees Fahrenheit. Preheating of the circuits by this means not only eliminates delamination of the circuits due to thermal shock under soldering heat, but also improves soldering. The preheat increases the mobility of the flux, enabling it to wet better. Also, solder pot temperatures are not reduced as radically by constant dipping, and therefore vary less.

Because of their relative non-corrosiveness and natural fluxing characteristics, rosin fluxes have been widely used in printed circuit soldering.

In selecting a rosin flux the following factors are important:

- Ability to promote soldering
- Low corrosion potential
- High leakage resistance across conductor pattern
- Breakdown resistance under accelerated environmental tests
- Methods of application possible
- Heat absorbing characteristics
- Anti-sputtering characteristics

### Fluxing

Flux may be applied to the work by floating the assembly in a container of the flux. The assembly is then removed, allowed to drain and placed directly in the solder pot. Flux can be sprayed onto work in mechanized operations and in other cases circuits have been dipped in flux and allowed to dry prior to assembly.

Most fluxes may be thinned by adding toluol, alcohol or similar solvents. Some fluxes lose a large part of their activity if allowed to remain too long before soldering. However, a short lapse of time between flux application and soldering has been found to be advantageous in that thorough "wetting" of the work takes place.

In applying the flux to the work spraying has been indicated as a technique. In addition to mechanization, a positive advantage is gained in that the relationship of the solids and solvent in the flux remain constant. In open dishes, trays or tanks the solvent evaporates, and while additions are made positive control is difficult. Specific gravity can be used as a control or an automatic viscosity device such as a Norcross Viscometer can be installed.

In spraying with a fine mist, leads and terminals are wet more effectively, especially up in the holes, and less flux is consumed. There is also a more even deposition of flux generally. Automation of the fluxing step is accomplished by mounting the spray gun below the table or unit, with either the circuit passing over the gun or the gun moving back and forth to create its pattern.

In using a spray setup care should be taken to make sure that the tank that holds the flux is either of stainless steel, or black iron coated with a phenolic coating.

The solids in the flux are important. They effect the fluxing action and where the residue is left on after soldering the amount of residue being left on the work (solids) should be held as constant as possible. The finished product is generally tested with the flux residue remaining to determine if it is or could be detrimental. If the flux varies widely in solids either the flux must be controlled, or representative pieces must be tested after being subjected to environmental conditions.

### Dip Soldering

The solder in the pot must be maintained at the proper temperature. Solder (60% tin, 40% lead) melts at about 180 degrees Centigrade and since work placed in the pot tends to cool solder, a suitable margin above this temperature must be allowed. For small work (pieces up to 4" x 6" x 1/16"), about 210 degrees Centigrade is the minimum working temperature. This temperature may be increased to decrease the dipping time **provided the plastic** will not blister and the foil-to-plastic bond can withstand the higher temperatures. Many manufacturers report best results at temperatures near 265 degrees Centigrade.

The surface of the solder in the pot must be cleaned immediately prior to the soldering operation. This is to prevent solder oxides or decomposed flux from interfering with soldering.

**Four methods of handling an assembly in the solder pot are recommended:**

1. Place circuit assembly in solder **in a horizontal plane** and float to different areas in the pot.
2. Place circuit assembly in solder in a horizontal plane and **do not move about.**
3. Place circuit assembly in solder pot **at an angle** of about 60 degrees, first allowing one edge to touch the solder and then gradually reducing the angle until all of the circuitry is in contact with the solder. This "rocking" movement is continued until good solder coverage is obtained.
4. Flow-Soldering, in which the solder is raised up to the circuit panels by an impeller pump, which forces the metal upwards through an elongated nozzle so that it forms a stationary wave. The circuit panel is passed through the crest of this wave of molten solder, which solders the joints between the component leads and the copper conductors on the underside of the panel.

The finished dip soldered job should have a smooth, bright appearance. If the time-temperature relationship has been in-correct the solder will not have the frosty appearance which characterizes cold joints. There should be no large blobs or accumulations of excess solder on the printed conductors. These defects are usually caused either by insufficient time in the solder pot or too low solder temperature. Spots where the solder has not "taken" are caused usually by either insufficient flux or excessive dirt or oxidation on the printed circuit before soldering.

### **Cleaning**

In most high production operations in the radio, television or commercial field, the flux is not removed from the printed circuit after solder dipping. The activated fluxes normally used have very good insulation resistance in this dry state. It is therefore not necessary to clean boards other than for appearance reasons. Cleaning off the flux actually may be harmful from an electrical viewpoint unless it is done very thoroughly. The majority of fluxes become active in solution. Many flux cleaners have high boiling constituents which do not dry as readily as the solvents originally used in the flux. Undried residues of flux in the cleaning solution trapped under wire sleeving or inside of hard to reach spots in components, have been known to cause trouble. Most flux manufacturers therefore recommend that the flux be left in place.

If cleaning is necessary for aesthetic reasons it should follow dip soldering immediately, preferably while the board is still hot. The simplest cleaner is the same solvent that is used to dilute the flux. However, special preparations are available for the purpose. These can be had

with such special properties as non-flammability, non-toxicity, non-active on certain plastics, color coding inks as used on resistors, etc. When using a remover that will not attack the color codings on resistors, coatings on components, etc., it is desirable to immerse the entire assembly in the remover. Agitation of the remover with air, or the application of ultrasonics, assures complete removal of flux residues.

After agitation and brushing in this tray it is transferred to another reservoir of clean solution and then possibly to a third, so that after drying of the solvent no residue is left. When the first dip becomes too dirty it is replaced by the second and so on in a counter-current fashion in order to save solvent.

Vapor degreasers are very efficient flux removers provided that the temperature of the degreaser does not injure the type of components used on the boards. Before starting the assembly it is wise to see whether or not this will be a problem in the cleaning cycle.

### **Summary**

Success in the soldering of printed circuits cannot be attributed to any single product or procedure. It is the result of care and attention given to every step in the entire process, and to each product used.

1. The circuit should be protected immediately after manufacture to keep it free of oxides and other contamination. It should be protected with a coating that will assist ultimate soldering. Components and leads and terminals should also be protected.
2. The flux should be sprayed onto the surface.
3. Thorough environmental testing of the flux and the completed circuit will resolve the question of leakage and conductance due to the flux used.
4. The board should be preheated prior to the solder dip.
5. Solder pots should be of good design, preferably agitated so that solder temperatures remain uniform.

## SERVICE AND REPAIR OF PRINTED CIRCUITS

The printed circuit panel is comparatively easy to troubleshoot, since conductors are easily seen and practically all components, being mounted on one plane are easily accessible. Also, the use of pin-type terminals makes the obtaining of voltage readings quite easy.

Replacement of defective components is not difficult if reasonable care is used. However, the circuit panel can be damaged by excessive heat during the unsoldering or re-soldering of components, or if strong-armed methods are employed to remove a component. Over heating can deteriorate the adhesive bond between conductor and insulating base material.

Thus it should be kept in mind that circuit boards are in some respects quite delicate and without proper precautions can be easily damaged. Low wattage soldering irons or guns should be used in order to avoid subjecting the board to excessive heat during removal or installation of components.

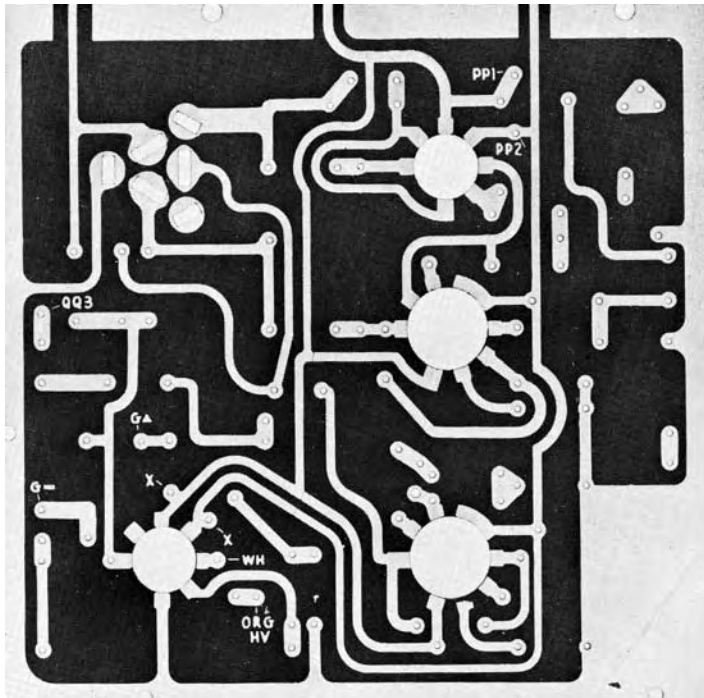

**Servicing can be simplified by printing identification of components and circuitry on the panel itself.**

Some special tools are very useful for particular repair problems. For example, a soldering gun tip may be revamped into a circular shape suitable for simultaneously contacting a multiplicity of terminals on such items as tube sockets, transformers, coils and potentiometers. The circular tip can be constructed with No. 8 or No. 10 copper wire.

Other semi special tools and materials include: 1. A solder melting pot with an opening of approximately 1-1/2 inches; 2. Silicone resin and solvent; 3. Masking tape; 4. Stiff bristled small brush (toothbrush will do).

### Repair of Foil

Two methods can be employed to repair damaged foil. If the break is small (1/32" or less), solder can be flowed across the gap. On larger breaks, both sides of the opening should be fairly heavily tinned, after which a piece of solid hook-up wire may be laid across the gap with a 1/16" overlay on each side, and then soldered to the end of the printed conductor. Insulated wire may be used if the break is large enough to cause a short circuit, or possibility of one.

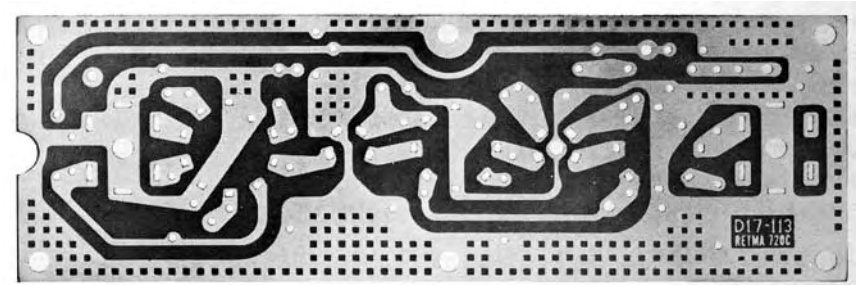

**Large ground areas in this panel have been relieved with openings in foil to permit gas escape and prevent blistering during dip soldering.**

### Raised Foil

Raised foil may be repaired by clipping off the raised section and replacing it with a section of wire as described above for breaks.

### Resistors and Capacitors

Replacement of resistors and capacitors (except "can" type capacitors) can be accomplished as follows. Leads on the original units should be cut as close as possible to the body of the unit. The old leads should be straightened perpendicular to the panel and the leads from the new unit looped around the old leads. The leads should then be soldered together and, if necessary, the old leads may be trimmed.

Complete removal of a component may be accomplished by cutting the leads on the original component as close as possible to the chassis.



The joint at the bottom of the chassis should be heated and each original lead pulled through the hole from the bottom of the panel. The holes should be cleaned before insertion of the new component. The new component leads are then bent over the bottom of the panel, excess leads clipped, and soldered.

### **Oscillator Coil, IF Transformer, Can-Type Electrolytic Capacitor, Variable Capacitor**

The circular formed shape mentioned above will make replacement of these items quite simple. However, a low wattage soldering iron applied to each individual lug and any molten solder brushed off with a small brush (toothbrush) will serve the purpose. However, when using a soldering iron and brush, caution should be exercised to prevent spreading of solder, which can cause possible leakages and shorts. To free the lugs from the copper strip, bend each lug to the center of the hole (while the solder is melted). With all the lugs free, the component may be lifted from the panel.

The following precautions must be taken when replacing an IF transformer: 1. Be sure to note the position of the lug bearing the color dot, as this lug should be used as a "guide" lug when inserting the new component. The manufacturer's number on the side of the can should NOT be used as a guide because the position of these numbers may vary with different manufacturers. 2. When a new IF transformer is installed, be sure a lug is not overheated, as this may cause solder to flow into the transformer and result in a short.

### **Controls**

Controls mounted directly on the printed circuit board may be replaced by cutting the leads to the control assembly about 1/4" above the chassis. The mounting bracket may be freed by heating the lugs one at a time and brushing away the solder until each lug is free. The assembly may then be lifted from the panel. Caution should be taken to straighten out bent lugs before removal of the bracket. While applying heat to the point at which the unit is soldered to the bottom of the panel, remove the leads that were previously clipped by gently pulling each one from the component side of the panel. Before insertion of the new control and soldering of same, all holes should be cleaned.

### **Printed Circuit Network**

A printed circuit network is a sub-printed circuit consisting mainly of resistors and capacitors. This network may be removed by heating each lug and brushing it to free it from the panel. A defective network may be more easily removed by first cutting it into small pieces with a pair of diagonal cutters. Dissection should be made so that individual lugs of the network will not be joined together by the remaining sections of the network. While gently pulling the lug from the component side of the panel, heat the same lug on the wiring side.

## **I.P.C. TOLERANCES**

### **INTRODUCTION**

The following table of tolerances is intended as a guide to engineers and designers to insure that their dimensional requirements can be met by the industry, and to prevent a choice of tolerances which may make the cost of the resulting printed circuit excessive.

These tolerances are by no means the ultimate and therefore, where closer than those listed are required, an IPC member manufacturer should be consulted on the specific design.

By keeping in mind standard metal fabricating techniques one may determine the best methods to use for short or long production. However, it must be remembered that the laminated plastics used in the manufacture of printed circuits do not have the dimensional stability of metal. Piercing and blanking dies for most printed circuits usually become economical for requirements of one thousand pieces and up. For small quantities up to 200 pieces drilling by eye and sawing or routing provides the fastest and most economical service. At this point, of course, tolerances must be considered. Drilling, for example, with hole position tolerances of plus or minus .010 or closer would require a jig of moderate cost. An irregular shape to the outside of the part will require a routing or milling fixture. Quantities not large enough to warrant dies would utilize production drill jigs or pantograph punching or drilling techniques.

Premium machining tolerances will usually result in higher tool costs and the operation cost may be affected. Where the pattern becomes involved, as for example in front pattern to back pattern registry, or location of a hole center or machined edge to pattern, the operation cost will rise sharply since special alignment means or printing methods are required. Premium hole to pattern registry can be achieved in a die, for example, if the pick-up or pilot holes for the die are drilled by optical alignment to the pattern under magnification. This added cost may, in many cases, not justify the resulting tolerance achieved.

## I.P.C. TOLERANCES

### 1. Unplated Holes—Diameters

Drilled	± .003"
Reamed	± .001"
Counterbored or flycut (Dias. 5/16"-4")	± .005"

Punched (1/16" thick)	Paper Base	Glass Base
Up to 1/4" Dia.	± .003	± .004
1/4"-1/2" Dia.	± .003	± .004
1/2"-1" Dia.	± .004	± .004
Over 1" Dia.	± .005	± .005

For thickness of 3/32" to 1/8", add ± .001 to above.

Routed slots and notches up to 2"- ± .005.

Milled or broached slots and notches to 2"- ± .003.

For punched slots and notches, consider both length and width as hole diameters.

### 2. Plated Holes—Diameters

ADD the following tolerances to the unplated hole tolerances shown above:

Drilled, paper base	± .002
Drilled, Glass base	± .003
Punched, paper base	± .003

### 3. Reference Hole to Hole Centerlines (plated or unplated)

	Standard	Premium
Die punched	± .005*1	± .003*1
Drilled by Eye	± .015*2	
Drilled by Temporary Jig	± .010*2	
Drilled by Jig Bored Jig	± .005*3	± .002*3
Drilled by Etched Steel Jig	± .010	± .010
Punched by temporary template	± .010*2	
Punched by Jig Bored Template	± .007	

### 4. Center of Hole to Center of Pattern:

#### PUNCHED

	DIE	TEMPORARY TEMPLATE	BORED TEMPLATE
Plated Holes, either side: Standard Premium	± .015	± .022	± .017
	± .010*4		
Single Side or Top of 2 sides: Standard Premium	± .015	± .017	± .017
	± .010*4		
Bottom of 2 Sides: Standard Premium	± .025	± .027	± .027
	± .020*4		

#### DRILLED

	EYE	TEMPORARY JIG	BORED JIG	ETCHED JIG
Plated Holes, either side: Standard Premium	± .020	± .015	± .020	± .015
			± .015*4	± .010*4
Single Side or Top of 2 sides: Standard Premium	± .015	± .015	± .015	± .015
			± .010*4	± .010*4
Bottom of 2 Sides: Standard Premium	± .030	± .025	± .025	± .025
			± .020*4	± .020*4

#### Standard

#### Premium

5. Front to Back Pattern Registration	± .020	± .010
6. Line Pattern to Outside Edge:		
Rout or Mill	± .015	± .010*4
Turn		± .005
Saw or Shear by Eye	± .030	
Saw by Jig	± .015*1	
Blank	± .015*1	± .010*1
Compound or Progressive Die	± .015*1	± .010*1

### 7. Reference Hole to Edge

Rout or Mill	± .010	± .015
Turn, T.I.R.	± .010	± .013
Saw or Shear by Eye	± .030	
Saw by Jig	± .015	
Blank, or Progressive Die	± .010*1	± .005*1
Compound Die	± .005*1	± .005*1

### 8. Overall Outside Dimensions

Rout or Mill	± .015	± .005
Turn		± .003
Saw or Shear by Eye	± .030	
Saw by Jig	± .010	
Blank by Die	± .003*1	± .003*1

#### Notes:

- \*1. Add ± .001 for every inch over 2 inches
- \*2. Tolerance based upon datum line passing through center of the reference hole pad.
- \*3. Add ± .001 for every 2 inches over 2 inches.
- \*4. Tolerance based on premium printing methods and/or optical alignment.

### 9. Line Width and Spacing Tolerances

	Standard	Premium
No Plating	± .010	± .005
With Plating	± .015	± .010

Line width tolerances do not include nicks, pin holes and scratches. These imperfections are acceptable providing the line is not reduced by more than 33%.

10. Plating thicknesses are specified as minimums only, a tolerance of minus 0, plus 100% being generally accepted.

### 11. WARP.

Pattern one side—finished part.

Measured according to ASTM-D709 or Mil P-406

Thickness	Paper Base	Glass Base
1/16	.025"/in.	.010
3/32	.020	.008
1/8	.012	.006
1/4 & up	.006	.005
Pattern two sides (Any thickness)	.007"/in.	.005

Closer warp tolerances may limit selection of raw materials or make necessary unusual manufacturing operations or shipping procedures.

### 12. Plug-in Contact Fingers

Where close tolerances between an edge or a key slot and contact finger of the conductor pattern are required, special fabricating techniques may be employed which will allow specifying a tolerance of ± .005 between the pattern on one side and the edge or slot. This will generally involve a premium cost. Remember to add front to back registry tolerance to determine condition on the reverse side.

### 13. PANEL THICKNESS TOLERANCES IN ± .000"

OVERALL THICKNESS	PAPER BASE		GLASS BASE	
	1 OUNCE 1 SIDE	1 OZ. 2 SIDES 2 OZ. 1 SIDE 2 OZ. 2 SIDES	1 OZ. 1 SIDE	1 OZ. 2 SIDES 2 OZ. 1 SIDE 2 OZ. 2 SIDES
1/32	0.004	0.005	.008	
3/64	0.005	0.006	.009	
1/16	0.0055	0.0065	.0095	
3/32	0.0075	0.0085	.0105	
1/8	0.0085	0.0095	.0135	
5/32	0.0095	0.010	.016	
3/16	0.010	0.011	.020	
7/32	0.011	0.012	.022	
1/4	0.012	0.013	.023	

### 14. PLATING THICKNESS

All plating will be produced to a stated minimum thickness with a tolerance of plus 100% minus nothing. On boards with plated holes, plating build-up on plug-in fingers may add as much as .003" to finger thickness on each side over and above specified minimum plating thickness.

### 15. SOLDER BLISTER RESISTANCE

Test Pattern—A 1" x 1" piece either etched or fabricated from sheet stock.

Test Method—1. Clean specimen with pumice or other scouring powder and water.

2. After rinsing in water and drying, flux with alcohol-rosin flux.

3. Immediately after fluxing float in molten 60-40 solder with copper side down.

4. Temperature: Paper base—485° plus/minus 10°  
Glass base—500° plus/minus 10°

5. Time: Paper base—10 sec. plus/minus 1 sec.  
Glass base—15 sec. plus/minus 1 sec.

#### OBSERVATION:

No blistering or delamination of either base laminate, adhesive layer or copper to base laminate. At least 90% of test area shall be solder coated to validate test. If specimen tested is clad two sides test must be performed on representative pieces of both sides.

**16. PEEL STRENGTH:**

As received condition.

TEST PATTERN—Shall be 1/8" etched lines at least 2" long taken crosswise and lengthwise from the sheet.

TEST METHOD —Copper to be pulled 90 normal to board in suitable universal testing machine with 1% accuracy, with continuous recorder. Jaws must grip foil across the entire foil width. Multiply results by 8 to convert to pounds per inch.

An average of 4 tests each for crosswise and lengthwise representing at least 2 specimens each. Report average and minimum single value.

TEST RESULTS —Peel strengths must average greater than the following:

- Paper Base—1 oz.—6 lbs.  
2 oz.—8 lbs.
- Glass Base—1 oz.—7 lbs.  
2 oz.—9 lbs.

After solder float (as per previous paragraph) using peel strength test panel and cooled to room temperature the peel strength shall not be less than 80% of above values. Protect copper surface during solder float from solder coat by applying a thin film of silicone oil or grease.

Results must be an average of at least 4 tests each for crosswise and lengthwise representing at least 2 specimens each. Report average and minimum single value.

**17. VOLTAGE BREAKDOWN**

D-C breakdown voltage in usage and after conditioning at 100°F. and 50% R.H. shall not exceed the following:

Spacing	Breakdown
1/16	2,000 V. DC
3/32	2,500 V. DC
1/8	3,000 V. DC
3/16	4,000 V. DC
1/4	5,000 V. DC
3/8	7,000 V. DC

**18. OVERLOAD CURRENTS**

Line Width	.00135" Conductors	.0027" Conductors
1/4"	20	30
1/8"	12	18
1/16"	8	12
1/32"	4	6

**19. WATER ABSORPTION ASTM DESIGNATION D-570**

Percent maximum water absorption on 1" x 3" sample after E-1/105°C. (220°F.) and D—24/23°C. (73°F.), 1/16" thick:

XP	XXP	XXXP	G-10 & G-11	Epoxy Paper
3.60	1.80	1.00	.50	.50

**20. DISSIPATION FACTOR ASTM Designation D-150**

1/32" to 1/4" thick laminates inclusive measured at 1 mc. maximum acceptable values:

	XP	XXP	XXXP	G-10 & G-11	Epoxy Paper
Cond. A	.045	.040	.035	.020	.030
Cond. D 24/23	.060	.050	.035	.025	.035

**21. INSULATION RESISTANCE AT 500 Volts D.C. in Megohms**

A. Taper pin method (D-257) Minimum single values:

	XP	XXP	XXXPC	G-10 & G-11	Epoxy Paper
Condition A	400,000	500,000	600,000	800,000	1,000,000
Cond. C-96/35/90	500	5,000	20,000	50,000	10,000

**22. VOLUME RESISTIVITY. ASTM Designation D-257**

Minimum Average Values in megohm—CM

	XXXPC	G-10 & G-11	Epoxy Paper
Cond. A	1 x 10 <sup>7</sup>	2 x 10 <sup>10</sup>	1 x 10 <sup>9</sup>
Cond. C-96/35/90	1 x 10 <sup>5</sup>	1 x 10 <sup>6</sup>	1 x 10 <sup>7</sup>

**23. DIELECTRIC CONSTANT**

At 1 megacycle, 1/32" to 1/8" inclusive, maximum values:

	XP	XXP	XXXP	G-10 & G-11	Epoxy Paper
Cond. A	5.50	5.00	4.60	4.30	4.00
Cond. D-24/23	6.10	5.30	4.80	4.50	4.50

## RELIABILITY

Much emphasis in circuit board manufacture and use at the present time is now in reliability concepts. Tremendous effort has gone into improving production processes, quality controls, raw materials and adhesives. Further efforts have been quite successful in improving the quality of solder connections.

These advancements have come in the early stages of large scale usage of printed circuits since 1953. Industry wide standardization has lagged far behind the application of printed wiring to products but as the acquaintanceship with the concept has spread, it is now believed that most segments of the design and manufacturing fraternities are ready to accept realistic standards and tolerances. The Institute for Printed Circuits presents the first such set in this booklet, which represents concurrence among its extensive manufacturing membership.

The printed circuit technique offers one very prominent assistance to reliability in that assemblies of electronic components and the leads connecting them almost have to follow the designer's plans; thus wiring errors are minimized and the presence of mistakes in component integration should be readily visible. The pre-positioned conductor and component layout has equal or greater potential in improving reliability on short runs as on high production assembly lines.

By the use of suitable packaging techniques the advantages of printed circuits may be extended to a very broad range of military applications where compactness, ruggedness, uniformity and reliability can accrue.

### Printed Circuit Standardization

The necessity of insuring uniformity of product has led many firms to establish design, procurement and processing standards for circuit boards. Where these standards have been based on full acquaintance with printed circuit manufacturing techniques, their efforts have resulted in highly reliable equipment and have provided designers with useful guides and criteria for realistically appraising the potential of the process. Use of the standards provided in this booklet will assist those designers who do not have the assistance of a company standard and the services of component engineers who have made detailed studies of realistic tolerances in the field. Custom circuit fabricators have, in recent years, often seen specifications calling for close metal machining or even jig boring tolerances on items where the application has no need of such specifications. Generally it can be said that one of the major contributing factors to those situations where printed circuit usage has proven unreliable is in over-engineering and over-specification in certain characteristics of the board itself with resultant degradation of other properties which may be affected.

The Military have not established dimensional tolerances or qualification procedures for evaluating printed circuit boards. However, they have published a number of design guides and established some standard test procedures. Thus, there are design criteria available for engineers to evaluate and properly exploit the advantages of printed wiring. It is suggested that the I.P.C. standards and tolerances be used in conjunction with these criteria.

### Materials and Processes

Specification of the proper laminate aids reliability and engineers have a wide choice available in a number of price ranges. (See section on materials.) For reliability considerations any printed circuit material should be evaluated from a processing and environmental standpoint as well as its application alone. Thought should be given to the various process operations to which it may be subjected as well as to its performance under temperature and humidity conditions.

Dimensional changes can occur in several processes which are almost always used in the manufacture of printed circuits. Baking operations used to dry acid or plating resist produces substantial shrinkage on paper base materials. Further shrinkage occurs during the etching operation as the copper plane (which did not shrink as much as the plastic in the cooling process following lamination) is relieved or removed. Vapor cleaning, curing of mask, heating to eliminate fracture during punching are other instances where the laminate must be exposed to heat. Glass base materials on the other hand show considerably less change and can be considered as more stable during heating and cooling as well as having superior mechanical characteristics with respect to impact and tensile strength. Processing operations may affect the electrical properties of laminates. Improper rinsing of circuit boards after etching can produce considerable degradation of insulation resistance properties. Chloride contamination, to be controlled, requires thorough and preferably automated rinsing of boards immediately after etching operations and a minimum exposure time to etching solutions is desirable. Dip soldering performance under proper time and temperature conditions and with proper fluxing agents is generally not thought to significantly deteriorate physical and electrical properties of the laminates, but again should be subject to standardized and control procedures.

The designer should evaluate laminate properties within three general areas as follows:

- (1) Electrical properties including surface resistivity, insulation resistance, dielectric strength, dielectric constant and arc resistance.
- (2) Mechanical properties including flexural strength, impact strength, machinability and dimensional stability under heat and humidity.

- (3) Chemical properties including resistance to etching solutions, solvents and plating baths.

It should be noted that whereas the glass base epoxy materials offer considerably superior mechanical properties and are widely specified for military and instrument application, their use in commercial applications is restricted not only by cost but in the case of U.L. listed equipment, by the fact that Underwriters will not recognize the presently available grades because of the toxicity of fumes which may be given off by the laminate when burned with a blow-torch.

The reliability of printed circuits can in many cases be improved by potting the entire assembly or using one of the commercially available epoxy, phenolic or melamine coating compounds. Similarly, protection of conductors by corrosion resistant electro-plated finishes will assure performance reliability under conditions of high temperature, high humidity, salt spray, etc.

A very high percentage of the relatively small number of printed circuit failures that have occurred has followed the selection of processes which have not been sufficiently evaluated and checked out over long periods of usage in various environments. There are literally dozens of circuit manufacturing techniques which have been introduced in the last ten years, but only a few of them have survived the rigors of mass use in a wide variety of applications and under all types of field conditions. It is suggested that the engineer, in deciding on the process which will be employed, carefully evaluate the technique in light of proven experience.

#### **Design Techniques to Assure Reliability**

One of the early decisions which must be made in circuit board design is whether to use a single sided or double sided board. Two sided circuitry is most generally used for compacting the wiring layout which may be necessary in miniaturized equipment and in airborne applications where component sizes are not the limiting factors. Two sided circuits tend to have less warp than will exist on single sided boards. For the ultimate in reliability the circuitry on one side of a board may be duplicated on the opposite side with the redundancy cutting the possibility of error by a factor of one-half. However, two sided circuit design may add complexity which will contribute to unreliability. For this reason, some design manuals will specify single sided wiring wherever possible even though it may mean the use of hand inserted jumper wires and additional terminal hardware. Other sophisticated studies take the view that such hardware connections may themselves present more possible weak points.

For reliability in connecting circuit panels with card receptacle, most designs will specify plated contacts on a printed circuit edge pad using noble metals such as silver, gold or rhodium. Chamfering the edge of the printed board at the terminal fingers may further improve reliability by reducing the possibility of the connector terminal tearing or lifting the printed fingers from the board. Use of plated through holes versus eyelets, and the desirability of using the latter in addition to the former

are subjects which have received considerable study in reliability evaluations. Funnel shaped eyelets with a flange which does not trap flux or moisture appear to be preferable to the conventional types. Quality of plated holes can vary substantially depending on the manufacturing conditions and manufacturing skill employed, and this may affect through-conductivity, but there is little doubt that the capillary dip soldering effect which plated holes provide furnishes connections to component leads of extremely high reliability.

The selection of circuit board size is frequently a consideration in reliability and it is hard to generalize on whether large or small boards are to be preferred, since a number of other factors are interrelated. Some experienced designers have set up rules to limit board dimensions to sizes in a range from 6" x 6" to 6" x 12". However, other types of applications may gain more reliability from substantially larger boards because of the reduction of interpanel connections.



**Reliability is assisted by equipment such as this hipot testing fixture for complex panels. Using spring loaded test prods to contact adjacent circuits, the general area of a short circuit is located by indicator lights.**



### Check List on Design Techniques for Reliability

- (1) Use boards produced by well proven processes and suppliers—there has been considerable turnover in both.
- (2) Use free flowing lines and rounded corners in conductor and pad layout.
- (3) Keep conductor lengths as short as practical.
- (4) Maintain D.C. conductors near edges as much as possible.
- (5) Avoid crossing conductors with components.
- (6) Insist on clean readily solderable component leads.
- (7) Adhere to proven design standards and tolerances.
- (8) Consider electrical, mechanical and chemical characteristics of materials as well as U.L. and Military standards.
- (9) Provide heat sinks to avoid hot spots.
- (10) Support boards at intervals of not more than 4" for 1/16" to 3/32" thickness; not more than 5" for boards thicker than 3/32".
- (11) Space all component leads at least one and one-half times stock thickness.
- (12) Try to maintain holes no smaller than two-thirds stock thickness.
- (13) Lay out conductor lines which run near the edge of the boards to provide a 1/16" margin from outer blank.
- (14) Maintain minimum spacings of 1/32" between pads unless impossible.
- (15) Try to provide for at least 1/32" and preferably 1/16" copper around holes.
- (16) Provide 1/16" minimum width conductors to fullest extent possible.
- (17) Design line width at 1/32" minimum.
- (18) Avoid large unrelieved expanses of copper which can more easily blister during dip solder.
- (19) Use single sided circuit boards where practical, unless, for maximum reliability, redundant circuitry on both sides of board can be used.

### GOVERNMENT SPECIFICATIONS APPLICABLE TO PRINTED CIRCUITS

MIL-P-18177A	—Plastic Sheet, Laminated, Thermosetting, Glass Cloth, Epoxy-Resin
MIL-P-13949A	—Plastic Material, Foil Clad, Laminated (for auto-assembly)
MIL-P-3115	—Plastic Material, Laminated, Thermosetting, Sheets, Paper-Base, Phenolic-Resin
MIL-STD-275	—Printed Wiring for Electronic Equipment
MIL-STD-202A	—Test Methods for Electronic and Electrical Component Parts
FEDERAL-LP406	—Plastic, Organic, General Specifications, Test Methods
MIL-STD-429	—Terms and Definitions
MIL-P-21193	—Printed Wiring, General Specification
SCL-6225	—Design Requirements for Auto-sembled Army Signal Electronics Equipment
SCL-6254	—Modular Dimensioning of Electronic Parts
XAR-153	—Printed Circuit Boards

## BIBLIOGRAPHY

- Printed circuits.** Final report. U.S. National Bureau of Standards. Electronics Div., Engineering Electronics Section 1950.
- Development of printed electronic circuits.** Final engineering report. Kenyon Instrument Co. Inc., Huntington Station, N.Y. 1949.
- Study of printed resistors for printed circuits.** Final report. Balco Research Laboratories, Newark, N.J. (Balamuth, Cohen, Koppel, Hoffman and Poltarack) 1949.
- Development of printed electronic circuits.** First quarterly report. Kenyon Instrument Co. Inc., Huntington Station, N.Y. 1947.
- Development of printed electronic circuits.** Second quarterly report, Kenyon Instrument Co. Inc., Huntington Station, N.Y. 1947.
- Development of printed electronic circuits.** Third quarterly report, Kenyon Instrument Co. Inc., Huntington Station, N.Y. 1948.
- Development of printed electronic circuits.** Fourth quarterly report, Kenyon Instrument Co. Inc., Huntington Station, N.Y. 1948.
- Development of printed electronic circuits.** Fifth quarterly report, Kenyon Instrument Co. Inc., Huntington Station, N.Y. 1948.
- Development of printed electronic circuits.** Sixth quarterly report, Kenyon Instrument Co. Inc., Huntington Station, N.Y. 1948.
- Bonding of metal foils to plastics for use in printed circuits.** Gt. Brit. Ministry of Supply. Telecommunications Research Establishment. Gt. Malvern, Worcs. Eng. (Manfield and Robertson) 1949.
- Study of automatic unitized circuit techniques.** Final engineering report. Herlec Corp., Milwaukee, Wisc. 1951.
- Electronic equipment construction: New objectives—new techniques—new components.** Terminal report. Stanford Research Institute, Stanford, Calif. 1950.
- Resume of printed circuits.** U.S. Air Materiel Command, Engineering Div. Components and Systems Lab. Electronics Subdivision. (Jacobs) 1949.
- Study of automatic printed circuit techniques.** Final report. Balco Research Laboratories, Newark, N.J. (Balamuth, Cohen, Buskin, Brady and Gibbons) 1950.
- Study of automatic printed circuit techniques.** Fifth quarterly report. Balco Research Laboratories. Newark, N.J. (Balamuth and Cohen) 1949.
- Fabrication of dies for printed circuits.** Gt. Brit. Ministry of Supply. Telecommunications Research Establishment. Gt. Malvern, Worcs. Eng. (Brookes) 1950.
- Computer components fellowship no. 347.** Quarterly report no. 11. Mellon Institute of Industrial Research 1953.
- Metallic paints for printed electronic circuits and other uses.** (Metallic coatings on non-metallic materials) U.S. Navy Bureau of Aeronautics. (Wein) 1953.
- Transistorized wrist-radio.** U.S. Signal Corps Engineering Laboratories, Fort Monmouth, N.J. 1954.
- New shop techniques and developments.** Second annual report. USAF. Air Research and Development Command. Research Services Division, Cambridge, Mass. (Akerblom) 1954.
- Adhesive for composite material used in printed circuitry.** 1951.
- Computer components fellowship no. 347.** Quarterly report no. 1., second series. Mellon Institute of Industrial Research, Pittsburgh, Pa. 1954.
- Computer components fellowship no. 347.** Quarterly report no. 2., second series. Mellon Institute of Industrial Research, Pittsburgh, Pa. (Bowman, Schwertz, Haller, Milch, Moffat, Steinback and Mzenko) 1954.
- Investigation of printed circuit methods for three dimensional applications.** Interim engineering report no. 1, Sylvania Electric Products, Inc., Transformer Dept. Ipswich, Mass. 1953.

## BIBLIOGRAPHY (Cont.)

- Investigation of printed circuit methods for three dimensional applications.** Interim engineering report no. 2, Sylvania Electric Products, Inc., Transformer Dept., Ipswich, Mass. (Zack) 1953.
- Investigation of printed circuit methods for three dimensional applications.** Interim engineering report no. 3 (Zack) 1953.
- Computer components fellowship no. 347.** Quarterly report no. 3, second series. Mellon Institute of Industrial Research, Pittsburgh, Pa. 1954.
- Investigation of printed circuit methods of three dimensional applications.** Interim engineering report no. 4, Sylvania Electric Products, Inc., Transformer Dept., Ipswich, Mass. (Zack) 1954.
- Computer components fellowship no. 347.** Quarterly report no. 4, second series. Mellon Institute Research, Pittsburgh, Pa. 1954.
- Computer components fellowship no. 347.** Quarterly report no. 5, second series. Mellon Institute of Industrial Research, Pittsburgh, Pa. 1954.
- Computer components fellowship no. 347.** Quarterly report no. 6, second series. Mellon Institute of Industrial Research, Pittsburgh, Pa. 1954.
- Photographic silk screen process in the fabrication of printed electronic circuits.** U.S. Signal Corps. Engineering Laboratories, Fort Monmouth, N.J. (Bornemann) 1951.
- Printed circuit fabrication within SCEL.** (Includes Autosemby system of circuit fabrication) U.S. Squier Signal Laboratory. Components and Materials Branch. Fort Monmouth, N.J. (Danko and Lanzalotti) 1953.
- Computer components fellowship no. 347.** Quarterly report no. 7, second series. Mellon Institute of Industrial Research, Pittsburgh, Pa. 1955.
- Adhesive for composite material used in printed circuitry.** First quarterly progress report. Houghton Laboratories, Inc., Olean, N.Y. (Houghton and Lorenzini) 1953.
- Adhesive for composite material used in printed circuitry.** Second quarterly progress report. Houghton Laboratories, Inc., Olean, N.Y. (Houghton and Lorenzini) 1953.
- Adhesive for composite material used in printed circuitry.** Third quarterly progress report. Houghton Laboratories, Inc., Olean, N.Y. (Houghton and Lorenzini) 1953.
- Adhesive for composite material used in printed circuitry.** Fourth quarterly progress report. Houghton Laboratories, Inc., Olean, N.Y. (Houghton and Lorenzini) 1954.
- Adhesive for composite materials used in printed circuitry.** Fifth quarterly progress report. Houghton Laboratories, Inc., Olean, N.Y. (Houghton and Lorenzini) 1954.
- Adhesive for composite materials used in printed circuitry.** Sixth quarterly progress report. Houghton Laboratories, Inc., Olean, N.Y. (Houghton and Lorenzini) 1954.
- Adhesive for composite material used in printed circuitry.** Seventh quarterly progress report. Houghton Laboratories, Inc., Olean, N.Y. (Houghton and Lorenzini) 1954.
- Development of principles and techniques of integration and packaging of printed circuit assemblies.** Part I, final report. P. R. Mallory and Co. Inc., Indianapolis, Ind. (Aldred, Brodrick, Everhart and Hinebaugh) 1954.
- Adhesive for composite material used in printed circuitry.** Final report. Houghton Laboratories, Inc., Olean, N.Y. (Houghton and Lorenzini) 1956.
- Computer components fellowship no. 347.** Quarterly report no. 8, second series. Mellon Institute of Industrial Research, Pittsburgh, Pa. 1955.
- New shop techniques and developments.** Third annual report. USAF, Air Research and Development Command, Cambridge Research Center, Cambridge, Mass. 1955.

**NOTES:**

**BIBLIOGRAPHY (Cont.)**

**Printed wiring techniques.** USAF. Air Research and Development Command. Rome Air Development Center. Griffiss A.F.B., Rome, N.Y. (Forte and Shapiro) 1956.

**Computer components fellowship no. 347.** Quarterly report no. 9, second series. Mellon Institute of Industrial Research, Pittsburgh, Pa. 1956.

**Theoretical and experimental investigation of micro-wave printed circuits.** Final report. Airborne Instrument Laboratory, Inc., Mineola, N.Y. (Keen) 1956.

**Report on NRL progress.** U.S. Naval Research Lab. 1957.